



E104-BT5011A User Manual

V1.0

RF52811 BLE5.1 Low Power BLE to Serial Module



Content

1. OVERVIEW	1
1.1 INTRODUCTION	1
1.2 FEATURES	1
1.3 APPLICATION	2
2. PRECAUTIONS FOR USE	3
2.1 BLE DESCRIPTION	3
2.1.1 Connection gap, broadcast gap, scan gap	3
2.1.2 MTU	3
2.2 PRECAUTIONS FOR MODULE APPLICATION	4
2.2.1 Response of distance to data transmission rate	4
2.2.2 The master data sending rate is lower than the slave data sending rate	4
2.2.3 IOS device can not obtain the solution of module MAC address	4
2.2.4 Precautions for connecting Ebyte ble modules with modules from other manufacturers	4
3. PARAMETER	5
3.1 LIMIT PARAMETER	5
3.2 OPERATING PARAMETER	5
4. DIMENSION AND PIN DEFINITION	7
5. FUNCTION	9
5.1 ROLES	9
5.1.1 MASTER	9
5.1.2 slave	10
5.1.3 Observer	11
5.2 POWER MODE	11
5.2.1 Low power mode	11
5.2.2 Wakeup mode	12
5.3 DATA TRANSPARENT TRANSMISSION	12

5.4 MAC ADDRESS BINDING	12
5.5 CONFIGURATION	13
5.6 DATA INDICATION	13
5.6.1 Output delay	14
5.7 UUID DESCRIPTION	14
5.8 LONG RANGE	15
6. AT COMMAND	16
6.1 INSTRUCTIONS	16
6.2 ERROR CODE	16
6.3 STATUS PRINTING	17
6.4 INSTRUCTION LIST	17
6.4.1 AT test command	17
6.4.2 AT+RESET Reset command	18
6.4.3 AT+RESTORE Restore command	18
6.4.4 AT+VER Query software version number	18
6.4.5 AT+BAUD Serial port baud rate	18
6.4.6 AT+PARI Serial port check bit	19
6.4.7 AT+ROLE Bluetooth Role	20
6.4.8 AT+ADV Broadcast enable	20
6.4.9 AT+ADVINTV Broadcast gap	21
6.4.10 AT+NAME Broadcast device name	21
6.4.11 AT+CONPARAMS Connection gap tacit configuration	21
6.4.12 AT+DISCON Disconnect Instruction	22
6.4.13 AT+DATDLY Data Output Delay	22
6.4.14 AT+MAC Local MAC Address	23
6.4.15 AT+PEERMAC Connected Device MAC	23
6.4.16 AT+BOND Binding Enable	24
6.4.17 AT+BONDMAC Add Binding MAC Address	24
6.4.18 AT+BONDDEL Delete the MAC Address Specified by the Binding	25

6.4.19 AT+SCAN Broadcast Scanning	25
6.4.20 AT+SCANINTV Scanning Gap	25
6.4.21 AT+AUTH Air Configuration Authentication Password	26
6.4.22 AT+UPAUTH Modify Air Authentication Password	26
6.4.23 AT+PWR Transmitting Power	27
6.4.24 AT+SLEEP Enter Sleep Command Immediately	27
6.4.25 AT+LOGMSG Operation Status Output	27
6.4.26 AT+FNAME Name Filtering	28
6.4.27 AT+FRSSI Signal Strength Filtering	28
6.4.28 AT+PHY BLE PHY Instructions	29
7. QUICK START	30
7.1 QUICK GUIDE TO CONFIGURATION MODE	30
7.1.1 Serial port configuration	30
7.1.2 Air configuration	30
7.2 DATA TRANSMISSION	32
7.2.1 Data transparent transmission	32
8. HARDWARE DESIGN	34
9. FAQ	36
9.1 COMMUNICATION RANGE IS TOO SHORT	36
9.2 MODULE IS EASY TO DAMAGE	36
9.3 BIT ERROR RATE IS TOO HIGH	37
10. PRODUCTION GUIDANCE	38
10.1 REFLOW SOLDERING TEMPERATURE	38
10.2 REFLOW SOLDERING CURVE	39
11. RELATED PRODUCT	40
12. PACKAGE FOR BULK ORDER	43
13. REVERSION HISTORY	44

1. Overview

1.1 Introduction

E104-BT5011A is a serial to BLE Bluetooth master-slave integrated module based on Bluetooth protocol version 5.1. It is small in size and low in power consumption. It works in the 2.4GHz frequency band.

The E104-BT5011A module is developed by Chengdu Ebyte Electronic Technology Co., Ltd. based on NORDIC's nRF52811 chip. The module uses general AT commands to set parameters and is simple and quick to operate. The module only supports Bluetooth master, slave and observer modes. The module functionally supports low-power broadcast, data transparent transmission, and air configuration. Modules can be widely used in smart wear, home automation, home security, personal health care, smart home appliances, accessories and remote controls, automobiles, lighting, industrial Internet, smart data collection, smart control and other fields. Maximum support for data transmission with a baud rate of 921600bps.



This document only supports e104-bt5011a module. Downward compatibility.

1.2 Features

- Support Bluetooth BLE 5.1 protocol;
- Support two working modes of configuration and transparent transmission;
- Support automatic broadcast and automatic connection after startup;
- Support serial port wakeup;
- The master role supports multiple condition filtering;
- Support serial port transparent transmission;
- Support multiple serial port modes and baud rates;
- With PCB onboard antenna, no external antenna is required;
- Support Bluetooth parameter air configuration function;
- The maximum communication distance is 70m (@4dBm, 2Mbps);
- Support ultra-low power sleep, simultaneous broadcasting;
- Support MAC address binding, the maximum binding data is 8 devices (no distinction between master and slave);
- Support dynamic modification of transmit power. The maximum emission is 4dBm;
- Support sniffing function;

- Maximum MTU is 247bytes;
- Support 2M, 1M airspeed;

1.3 Application

- Wireless meter reading and wireless sensing
- Smart home
- Industrial remote control, telemetry
- Smart buildings, smart buildings
- Automatic data collection
- Health sensor
- Smart wearable devices
- Intelligent robot
- Wireless sensing
- Electronic label
- Intelligent control

2. Precautions for use

2.1 BLE description

This section briefly introduces BLE related knowledge. It has nothing to do with the module.

2.1.1 Connection gap, broadcast gap, scan gap

In order to ensure low power consumption, BLE adopts intermittent working mode.

The scanning interval means scanning the broadcast channel every certain time. The smaller the scan gap, the higher the average power consumption during the scan, but the faster the slave device is found, and vice versa.

The broadcast interval is to publish a broadcast every certain time. The smaller the broadcast gap, the easier it is for the slave device to be discovered by the master, and the higher the average power consumption.

For connected BLE devices, the master initiates a request to the slave every certain time (connection gap), and after receiving the request, the slave responds to the master's request at the same time (connection gap). If the slave does not respond to the master request within the specified time (connection timeout), the master judges that the slave is disconnected, and the slave fails to receive the request from the master within the specified time (connection timeout), the slave judges that the master is disconnected connection. In order to reduce BLE power consumption again, the BLE protocol also stipulates that the slave can ignore the specified number of requests (slave timeout).

The smaller the connection gap, the greater the data throughput, but the greater the power consumption. If users are concerned about data throughput, the connection gap can be reduced.

Note that for the connection gap, the connection gap may be different for different devices, or even cannot be changed, such as iphone.

2.1.2 MTU

It refers to the effective size of BLE air single packet data. The MTU of the ble4.0/4.1 protocol is 27 bytes, and the MTU can be expanded to 251 bytes from ble4.2 and higher.

When the MTU is actually used, how can the user's effective minus be reduced by 3 bytes of the header. This means that the maximum single packet data for 4.0/4.1 users is 24 bytes, and the maximum single packet data for ble4.2 and higher is 247 bytes.

Need to explain. In practical applications, the MTU value of different devices will be different. For example, the MTU of iPhone is 185 bytes, and the user cannot change it.

2.2 Precautions for Module Application

2.2.1 Response of distance to data transmission rate

The module uses a ceramic antenna. Compared with the PCB antenna, the ble wireless signal has a weaker transmitting and receiving ability. As the distance increases, the data speed decreases.

2.2.2 The master data sending rate is lower than the slave data sending rate

Because the slave sends data using the notification method to send data, the data sending rate is faster, while the master sends data using the write response method, and the data sending rate is slower.

2.2.3 IOS device can not obtain the solution of module MAC address

Due to IOS system limitation, APP cannot obtain the MAC address of the module. The module provides a solution: add a MAC address field in the broadcast packet (only BT5011A). For details, please refer to "6.1.2 Slave".

2.2.4 Precautions for connecting Ebyte ble modules with modules from other manufacturers

When the Ebyte ble module is used as a slave, it does not refuse connections from other manufacturers' masters. But the communication needs to communicate in the way shown in [5.7UUID description].

When the Ebyte ble module is used as the master, there are two precautions for connecting to other manufacturers' modules:

1. The Ble broadcast content must include the service UUID, and the UUID is consistent with the service UUID set by the master;
2. Services and characteristics, and characteristic attributes must be consistent; receiving operations must be consistent. Refer to **【5.7UUID description】** .
3. The ble connection process of other manufacturers has no authentication binding process.

3. Parameter

3.1 Limit parameter

Main parameter	Performance		Note
	Min	Max	
Voltage supply [V]	0	3.6	Voltage over 3.6V will cause permanent damage to module
Blocking power [dBm]	-	10	Chances of burn is slim when modules are used in short distance
Operating temperature [°C]	-40	+85	Industrial grade

3.2 Operating parameter

Main parameter		Performance			Remarks
		Min	Typ	Max	
Voltage supply [V]		1.7	3.3	3.6	≥3.3 V ensures output power
Communication level [V]			3.3		For 5V TTL, it may be at risk of burning down
Operating temperature [°C]		-40	-	+85	Industrial design
Frequency [MHz]		2402	-	2480	Support ISM band
Power consumption	Transmitting current (mA)	-	13	19	-
	Receiving current (mA)	-	13	-	-

	Sleep current (μA)	-	8	-	-
Maximum transmitting power (dBm)		-	3.8	4	-
Receiving sensitivity (dBm)		-	-96	-	Bluetooth®lowenergymode
Arbitrary I/O	VIL/VIH		GND/0.84	GND/VCC	0.36/VCC
	VOL/VOH		GND/1.88	GND/VCC	0.47/VCC
Sleep broadcast current (default)		-	13.83	-	Unit: uA. Broadcast gap is 1s
Sleep connection current (default)		-	6.89	-	Unit: uA. Broadcast gap is 1s

Main parameter	Description	Remarks
Distance	70m	Test condition : Clear and open environment, height 2.0 meters; @4dBm; air speed: 1Mbps
BLE protocol	BLE5.1	-
Communication interface	UART	-
Package	SMD	-
Connector	1.27 mm	-
Size	11.6*16mm	-
Antenna	Ceramic antenna	50Ω Impedance

4. Dimension and Pin Definition

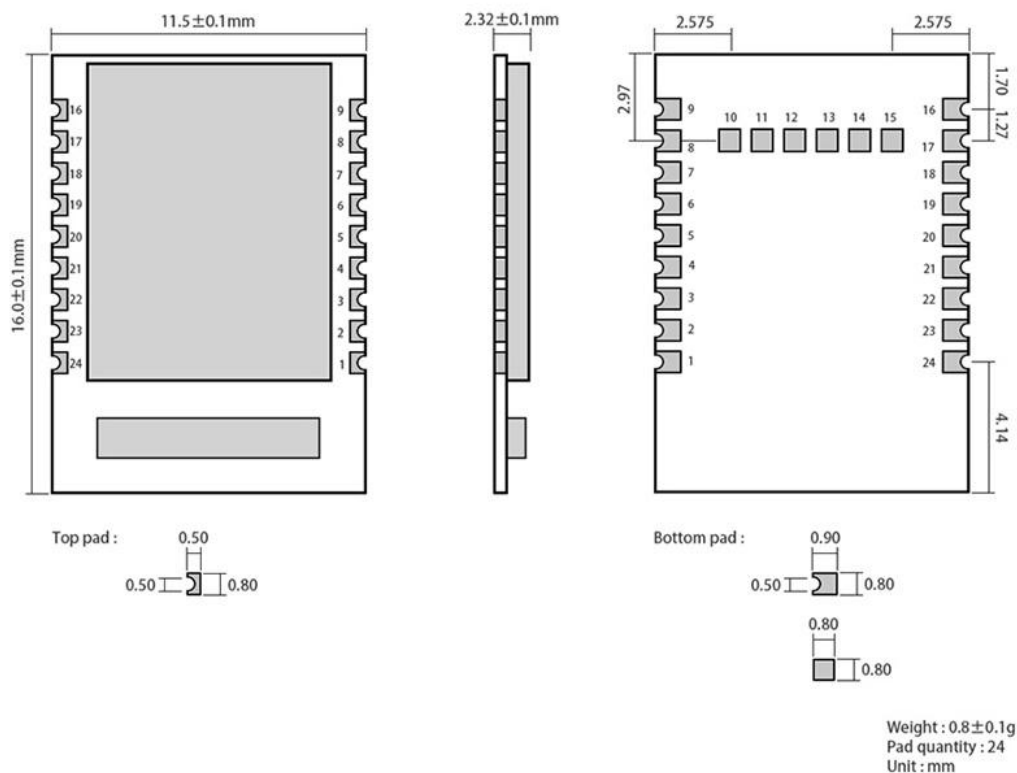

¹ The internal level of the pin is self-latched. Ground directly or connect to the power supply when driving externally. When driven by an external MCU, use compelling output control.

No.	Item	Direction	Application	Remarks
1	GND	Input	Ground	
2	P0.25	--	NC	
3	P0.26	--	NC	
4	MOD ¹	Input	Mode selection	Low level: configuration mode;

				High level: transparent transmission mode.
5	WKP ²	Input	Wake-up pin	Wake up: falling edge Sleep: rising edge
6 ⁴	DISC Same as 3.	Input	Disconnect pin	Internal pull up. Active on falling edge
7	LINK ³	Output	Connection Status	Bluetooth connection: low level Bluetooth no connection: high level
8	DATA ⁴	Output	Data indication	Data indication pin
9	GND	--	Ground	
10	P0.02	--	NC	
11	P0.03	--	NC	
12	P0.04	--	NC	
13	P0.05	--	NC	
14	P0.06	--	NC	
15	P0.07	--	NC	
16	GND	--	Ground	Ground
17	VCC	--	Power is positive	Power is positive
18	RXD	Input	UART RX pin	
19	TXD	Output	UART TXpin	
20	RTS	Output	Flow Control	Internal pull up
21	CTS	Input	Flow Control	Internal pull up
22	P0.21/RS		Power reset	Active low

	T			
23	SWDCL K	--	--	--
24	SWDIO	--	--	--

引脚内部电平自锁存。为高电平时，内部上拉，为低电平，内部下拉。**The internal level of the pin is self-latched. When it is high, it is internally pulled up, and when it is low, it is internally pulled down.**

Chart 4 1 Pin definition table

5. Function

5.1 Roles

The module supports three roles: single master, single slave, and observer.

Single master and single slave support connecting to other types of Bluetooth products of our company. Support data transparent transmission, support custom broadcast gap, scan gap, connection gap, support setting PHY.

The observer is only used to print the broadcast information of the ble devices around the module and cannot be connected. Also supports conditional filtering.

5.1.1 Master

1. AT+ROLE=1 to select the host role. Restart to take effect after changing the role;
2. Command AT+SCAN=1 to open the host scan function;
3. Print status information when the host connection status changes. See 6.3 Status Printing.

5.1.1.1 Condition filtering

The device can be configured to bind MAC address, service UUID filtering, RSSI filtering and NAME filtering. The four filtering methods can be used simultaneously, or individually enabled or disabled, **but the service UUID filtering cannot be disabled.**

- Service UUID filtering: The broadcast data of the slave must contain a 16-bit UUID field, and the UUID is 0xFFFF0.

- **MAC address filtering:** If users need MAC address filtering, they need to enable MAC address filtering through AT+BOND=1, and add MAC addresses to the host through AT+BONDMAC. After the master scans the slave, if it is the same as the binding list MAC address and service UUID, the master automatically connects to the slave device.
- **NAME filtering:** The broadcast data of the slave must include a name field, and the name must be a full name. If it matches, it will automatically connect. The name matching method is partial matching. For example: the name filter has been enabled and the filter name is "E104-BT50"; then "E104-BT50", "E104-BT501", and "E104-BT5011" can all be matched successfully, but "1E104-BT50", E104-BT5 Will be filtered out.
- **RSSI filtering:** The host can filter out modules that are less than the set filtering RSSI value.

5.1.2 slave

1. AT+ROLE=0 to select slave mode (valid after restart);
2. AT+ADV=1 to enable broadcast;
3. The broadcast switch is configured to be on, and it will automatically enter the broadcast state after power-on, otherwise the broadcast device will not be found.
4. After receiving the host connection request, establish a Bluetooth connection to stop Bluetooth broadcasting and enter the data transparent transmission mode.

The module broadcast data format is as follows:

FLAGE			Service UUID			MAC address				Name		
Len	Type	Flage	Len	Type	Uuid	Lan	Type	Mac type	Mac	Len	Type	name
1	1	1	1	1	2	1	1	1	6	1	1	Maximum 15 bytes
02	01	06	03	03	F0 FF	08	1B	01	A9 08 C0 70 D2 CE	0D	09	45 31 30 34 2D 42 54 35 30 31 31 41

Chart 5 -1 Broadcast packet format

In the IOS system, the MAC of the connected module cannot be obtained through the system API. The MAC in the broadcast data packet provides a way for the IOS system to obtain the MAC address.

Broadcast packet data field description:

Field	Value	Description
-------	-------	-------------

FLAGE→FLAGE	0x06 (Fixed value)	ble general discovery mode, BR/DER is not supported;
Service UUID→UUID	0xFFFF0 (Fixed value, Little endian)	Module serviceUUID
MAC address→mac type	0x01 (Fixed value)	Static random address
MAC address→mac	6 bytes	Module MAC address

Chart 5 -2 Broadcast field description

5.1.3 Observer

1. Command AT+ROLE=2 to select the observation mode (valid after restart)
2. After receiving the broadcast, print out all the contents of the broadcast package through the serial port.
3. The observer device cannot be connected to any device.

The format is as follows:

LEN	MAC	RSSI	Advdata
1 byte	6 bytes	1 bytes	No more than 31 bytes

Chart 5- 3 Observer data output format

Note: LEN is the sum of MAC, RSSI, and broadcast data length.

4. During this period, only AT commands are valid, and data transparent transmission is not supported.
5. All observations support RSSI, name, mac address filtering;

5.2 Power mode

The module supports two power modes: low power consumption mode and wake-up mode.

5.2.1 Low power mode

The so-called low power consumption mode means that the BLE function continues to run after the module enters this mode, and peripherals other than the wake-up pin of the module are turned off. If you need lower power consumption, you can turn off broadcast and scan through AT commands, disconnect all connections, and set a longer broadcast gap, scan gap, and connection gap.

Enter low power consumption:

1. AT command "AT+SLEEP" immediately enters low power consumption mode;
2. Pass the rising edge of pin WKP, and enter low power consumption immediately after the high level is maintained for 200ms or more;

After the module enters the low power consumption mode, it outputs "STA: sleep" through the serial port (LOGMSG does not turn off the output).

Note:

1. *1. In the low-power mode, when the connection is not disconnected, such as ble receives air data, or the connection status changes, the module temporarily wakes up and outputs the corresponding data, and immediately enters sleep after the data output is completed. At this time, low power consumption or wake-up will not output status data.*
2. *2. If the serial port is configured for flow control and CTS fails, the low power consumption mode cannot be entered.*

5.2.2 Wakeup mode

The so-called wake-up mode means that the peripherals required by the module in this mode are in a normal working state. After the module wakes up, it outputs the status "STA: wakeup".

1. Wake-up method:
 1. Wake up immediately after the falling edge of WKP pin, and the low level is maintained for more than 200ms;
 2. The serial port RX pin wakes up. The serial port rx falling edge, and the low level keeps 50us and above, wake up immediately.

5.3 Data Transparent Transmission

The so-called data transparent transmission means that the data received by the serial port is sent to the other device through BLE without any processing, and the data received by BLE is sent through the serial port without any processing.

Regardless of the master, the slave role only supports data transparent transmission. The observer does not support transparent data transmission.

5.4 MAC address binding

The module supports MAC address binding. If the MAC address binding function is enabled. The device only connects to devices with added MAC addresses.

5.5 Configuration

The module supports two configuration methods: serial port configuration and air configuration. The two configuration methods are basically the same. Before the air configuration, the authentication password of AT+AUTH=123456 must be passed. After the authentication is passed, the module is allowed to use the air configuration. The air configuration authentication period is this connection, and re-authentication is required if the device is disconnected and reconnected.

The module is in configuration mode before the connection is established. The Mod pin is invalid.

After the connection is successful, determine whether the module is currently in configuration mode or data transmission mode according to the mod pin level. When mod is high, it is data transmission mode, when it is low, it is configuration mode.

When the Mod pin detects a valid change, the current state is latched. The hold time for each state change is more than 200ms valid.

The Mod pin does not affect the air configuration.

In configuration mode, the master sends data to “MAST CHANNEL”, and the slave returns “CONFIG BUSY” through “SLAVE CHANNEL”.

5.6 Data indication

When the module outputs data through the serial port, the module sets the DATA pin to low level, indicating that data is being sent. AT command response does not change the DATA pin state.

The module can turn on the data output delay through AT+DATA LY=1. After the data output delay is turned on, the module first pulls the DATA pin and outputs data after 10ms.

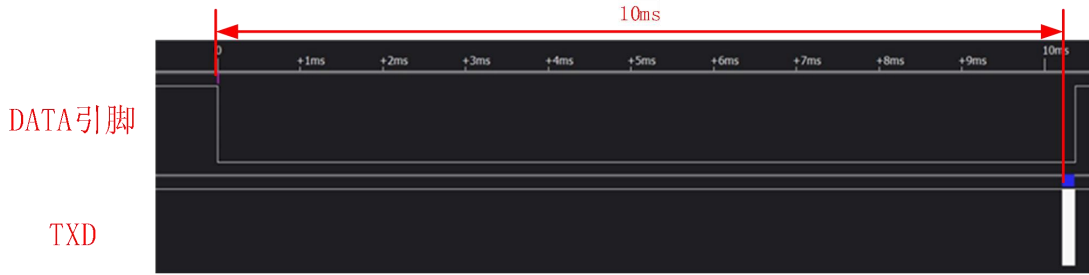

Chart 5- 4 Data output delay chart



Chart 5-5 Data output without delay

5.6.1 Output delay

If the output delay is turned on, after the module receives the air data, it first pulls down the DATA pin, and then outputs the data via UART after 10ms. It should be noted:

- After the output delay is turned on, streaming is not supported. The maximum data size of each packet does not exceed 244 bytes;
- After the output delay is turned on, if the air data packet is received too fast, the entire data packet will be lost.

The output delay is usually applied to the user MCU sleep situation. After the module receives the air packet, it wakes up the user MCU through the DATA pin, and outputs data through UART after the user MCU is stable.

5.7 UUID Description

Service UUID	FFF0 (not configurable)		
characteristic value	UUID	Attribute	Description
SLAVE CHANNEL	FFF1 (not configurable)	read / notify	The slave sends the data, and the master receives the data channel.
MAST CHANNEL	FFF2 (not configurable)	read / write	The host sends data and the slave receives

	configurable)		data channels
CONFIG CHANNEL	FFF3 (not configurable)	read / write / notify	Air configuration channel

Chart 5 -6 UUID list

- When the module is in the slave role, it uses the NOTIFY method to send data. There are two ways for the master to receive data from the slave: manual reading and automatic reception after using NOTIFY. The master role of Ebyte ble module can be automatically received by enabling NOTIFY, and the user does not need to care. This receiving method is only used when the user develops APP, WeChat applet or master module by himself.。
- When the module is in the master role, it uses WRITE to send data.
- Because of the difference between the master and slave data transmission methods, the throughput of the number of slaves sent is much higher than the throughput of the master.
- When using air configuration, the host uses WRITE to send AT commands, and the module uses NOTIFY to respond to AT commands.

5.8 Long range

Long Range is a new feature added in BLE 5.0. The Long Range feature greatly improves the communication distance of Bluetooth, which can reach thousands of meters in open areas. The increase of Bluetooth communication distance also broadens its application scenarios.

Only need to set PHY to code to use long range. Note: The master and slave must be set to the same (code), and the data throughput of this module is greatly reduced. If you use other modules of our company, modules of other companies or mobile phones, you need to pay attention to whether it can support ble long range.

6. AT Command

Note: Before sending operation instructions, first ensure that the module is in wake-up mode, otherwise it will not be able to receive configuration instructions.

6.1 Instructions

- All AT commands and responses do not need to add carriage return (r), line feed (n)
- Command error response format +ERR=[NUM]. (NUM is ASCII)
- AT command parameter format: [para]. Does not contain [].

6.2 Error code

NUM	Description	Cause of error	Solution
1	unknown error		
2	Invalid parameter	1、 Parameter out of range; 2、 Wrong number of parameters;	Check parameters
3	Number parameter length	1、 Field string type, HEX group number type has read over the maximum or under the minimum length limit	Check the parameter length against the command
4	Parameter is empty		Check parameters
5	busy	1.Parsing instructions;	Resend the instruction later
6	role	1.The current role does not support this operation.	Confirm the current role of the module
7	not connected	1.The current device is not connected and this operation is not supported.	
300	MAC address not found		
301	MAC binding list is full	Mac binding can bind 8-bit address at most.	Delete the invalid address and add it again.

304	The MAC address already exists.	The MAC address is already in the binding list.	
400	The AT command does not exist.		Check AT commands.
401	The authentication password is incorrect.		Confirm whether the authentication password is correct: the default password is "123456" (string).
402	The AT command exists, but the operation is not supported.		Check the instructions to determine the operation.

Chart 6 -1 Error code table

6.3 Status printing

Status	print information
connection succeeded	\r\nSTA:connect\r\n
Disconnect	\r\nSTA:disconnect\r\n
System wake up	\r\nSTA:wakeup\r\n
Sleep mode	\r\nSTA:sleep\r\n
Configuring (not transparent transmission)	\r\nCONFIG BUSY\r\n

Chart 6 -2 Status printing table

6.4 Instruction list

6.4.1 AT test command

Command	Response
AT	+OK
Description: None	

6.4.2 AT+RESET Reset command

Command		Response
AT+RESET		+OK
Description:	Effective immediately	

6.4.3 AT+RESTORE Restore command

Command		Response
AT+RESTORE		OK
Description:	<ol style="list-style-type: none"> 1. After resetting, it will restart automatically; 2. In the process of restoring factory settings, any form of reset is prohibited, and the power off before the operation is completed is prohibited; 	

6.4.4 AT+VER Query software version number

Command		Response
Inquire	AT+VER?	+OK=[ver]
parameter	ver:version number	
Description	Effective immediately	
Example	instruction: AT+VER? return: +OK=V1.0.0	

6.4.5 AT+BAUD Serial port baud rate

Command		Response
Inquire	AT+BAUD?	+OK=[para]
set	AT+BAUD=[para]	+OK: success +ERR=[NUM]: error
parameter	para (ASCII)	Baud rate(bps)
	0	1200

	1	2400
	2	4800
	3	9600
	4	14400
	5	19200
	6	28800
	7	38400
	8	57600
	9	76800
	10	115200 (default)
	11	230400
	12	250000
	13	460800
	14	921600
Description	Restart to take effect	
Sample	AT+BAUD=10. Set the baud rate to 115200 HEX: 41,54,2B,42,41,55,44,3D,31,30	

6.4.6 AT+PARI Serial port check bit

Command		Response
Inquire	AT+PARI?	+OK=[para]
Set	AT+PARI=[para]	+OK: success +ERR=[NUM]: error
parameter	para(ASCII)	description
	0	No inspection (default)
	1	Even parity
Description	Restart takes effect and save when power off.	

Sample	AT+PARI=0
---------------	-----------

6.4.7 AT+ROLE Bluetooth Role

	Command	Response
Inquire	AT+ROLE?	+OK=[para]
Set	AT+ROLE =[para]	+OK: success +ERR=[NUM]: error
parameter	Para(ASCII)	description
	0	Slave (default)
	1	Master
	2	Observer
Description	Restart takes effect and save when power off.	

6.4.8 AT+ADV Broadcast enable

	Command	Response
Inquire	AT+ADV?	+OK=[para]
Set	AT+ADV=[para]	+OK: success +ERR=[NUM]: error
parameter	para (ASCII)	Description
	0	Turn off broadcast
	1	Start normal broadcast (default)
Description	Take effect immediately (if the broadcast is not turned on, or it is connected, it will take effect next time), save when power off; Only the slave supports broadcasting.	

6.4.9 AT+ADVINTV Broadcast gap

	Command	Response
Inquire	AT+ADVINTV?	+OK=[para]
Set	AT+ADVINTV=[para]	+OK: success +ERR=[NUM]: error
parameter	para(ASCII):32~16384 Default: 1600 (1S)	
Description	Take effect immediately (if the broadcast is not turned on, or it will take effect next time if connected), save when power off Only the slave supports broadcasting, other roles can still be configured;	
Sample	AT+ADVINTV=1600 Set the broadcast gap: 1600*0.625=1S	

6.4.10 AT+NAME Broadcast device name

	Command	Response
Inquire	AT+NAME?	+OK=[para]
Set	AT+NAME=[para]	+OK: success +ERR=[NUM]: error
parameter	para(HEX): broadcast device name, Broadcast name is not more than 13 bytes Default: E104-BT5011A	
Description	Take effect immediately, save when power off; Only supported by the slave, other roles can still be configured;	

6.4.11 AT+CONPARAMS Connection gap tacit configuration

	Command	Response
Inquire	AT+CONPARAMS?	+OK=[intv],[latency],[timeout]

Set	AT+ CONPARAMS =[intv],[latency],[timeout]	+OK: success +ERR=[NUM]: error
parameter	[intv] (ASCII): Connection gap, value range, 6~3200; [latency] (ASCII): Slave device delay. Value range, 0~499 [timeout] (ASCII): connection timeout, value range, 10~3200 Default value: 16, 0, 400	
Description	Save when power off.	
Note	The connection timeout must be greater than the connection gap; Timeout *4> (1 + latency)* intv; Incorrect parameters will not be saved by the device. Only the default parameters of the connection parameters are set. After the setting is completed, the currently connected link will not be affected. It is not recommended to set the connection parameters of the host too large. This will cause the connection time to be too long, and during the connection process, all data received by the serial port is discarded.	
Sample	AT+CONPARAMS=16,0,400 Connection gap 16*1.25ms, slave device delay: 0, 16*1.25ms, connection timeout 400*1.25ms	

6.4.12 AT+DISCON Disconnect Instruction

	Command	Response
instruction	AT+DISCON	+OK: success +ERR=[NUM]: error
parameter	No	
Description	Effective immediately. Disconnect all connections, master-slave mode can be used;	

6.4.13 AT+DATDLY Data Output Delay

	Command	Response
--	---------	----------

Inquire	AT+DATDLY?	+OK=[para]
Set	AT+DATDLY=[para]	+OK: success +ERR=[NUM]: error
parameter	para (ASCII)	description
	0	shut down
	1	On (default)
Description	<p>Take effect immediately, save when power off;</p> <p>Turn on the output delay, the maximum data packet does not exceed 244 bytes;</p> <p>Turn on the output delay, and the air packet input is too fast, which will cause the entire packet to be lost.</p>	

6.4.14 AT+MAC Local MAC Address

	Command	Response
Inquire	AT+MAC?	+OK=[para]
parameter	para (HEX): MAC address Example: F0E1D2C3B4A5	
Description	Take effect immediately, save when power off.	
Sample	Command: AT+MAC? Return: 2B 4F 4B 3D DA 35 50 EE 30 FE Explanation: The local MAC address is DA 35 50 EE 30 FE	

6.4.15 AT+PEERMAC Connected Device MAC

	Command	Response
Inquire	AT+PEERMAC?	+OK: success +ERR=[NUM]: error
parameter	MAC (HEX) :MAC address;	
Description	Take effect immediately.	

Sample	Command: AT+PEERMAC? Return: 2B 4F 4B 3D FE 30 EE 50 35 DA Explanation: The MAC address of the connected device is FE 30 EE 50 35 DA
---------------	--

6.4.16 AT+BOND Binding Enable

Command		Response
Inquire	AT+BOND?	+OK=[para]
Set	AT+BOND=[para]	+OK: success +ERR=[NUM]: error
parameter	para (ASCII)	description
	0	Binding is off (default)
	1	Bind on
Description	Take effect immediately, save when power off.	

6.4.17 AT+BONDMAC Add Binding MAC Address

Command		Response
Inquire	AT+BONDMAC?	+OK=[sum][[mac] [mac]...]
Set	AT+BONDMAC=[mac]	+OK: success +ERR=[NUM]: error
parameter	sum(HEX): the total number of currently bound MAC addresses; mac(HEX): 6bytes mac address;	
Description	Take effect immediately, save when power off	
Sample	Query: AT+BONDMAC? Return: B 4F 4B 3D 03 CC 34 27 1A 0C D4 3D AC 82 16 0F 58 D2 D4 C3 07 0E C4	
		Settings: 41 54 2B 42 4F 4E 44 4D 41 43 3D CC 34 27 1A 0C D4 Return: +OK

6.4.18 AT+BONDDDEL Delete the MAC Address Specified by the Binding

Command		Response
Set	AT+BONDDDEL=[mac]	+OK +ERR=[NUM]
parameter	mac: 6bytes mac address	
Description	Take effect immediately, save when power off. 2. Delete all MAC addresses when the MAC address is (0xff, 0xff, 0xff, 0xff, 0xff, 0xff), otherwise delete the specified mac address;	

6.4.19 AT+SCAN Broadcast Scanning

Command		Response
Inquire	AT+SCAN?	+OK=[para]
Set	AT+SCAN=[para]	+OK: success +ERR=[NUM]: error
parameter	para (ASCII)	Description
	0	Turn off scanning
	1	Turn on scanning (default)
Description	Take effect immediately, save when power off If the current number of host connections has reached the maximum, then no longer start scanning; Scanning enable and disable only take effect in the role of host or observer.	

6.4.20 AT+SCANINTV Scanning Gap

Command		Response
Inquire	AT+SCANINTV?	+OK=[intv],[wnd]
Set	AT+SCANINTV=[intv],[wnd]	+OK: success +ERR=[NUM]: error

parameter	Intv: is the scan gap, Wnd: scan window
Description	1. Take effect immediately, save when power off, 2. The scanning gap is not less than the scanning window 3. The slave does not support it, but it can still be set
Sample	

6.4.21 AT+AUTH Air Configuration Authentication Password

Command		Response
Set	AT+AUTH =[para]	+OK: success +ERR=[NUM]: error
parameter	para(HEX): 6-byte password	
Description	This directive is only used for air certification. Default password (ASCII): 123456 After successful authentication, this command is not available.	
Sample	AT+AUTH=123456	

6.4.22 AT+UPAUTH Modify Air Authentication Password

Command		Response
Inquire	AT+UPAUTH?	+OK=[para]
Set	AT+UPAUTH =[para]	+OK: success +ERR=[NUM]: error
parameter	para(HEX): 6-byte password	
Description	Effective immediately. Power-down save	

6.4.23 AT+PWR Transmitting Power

Command		Response
Inquire	AT+ PWR?	+OK=[para]
Set	AT+ PWR =[para]	+OK: success +ERR=[NUM]: error
parameter	para(ASCII)	val
	0	4 dBm
	1	3 dBm
	2	0 dBm (default)
	3	-4 dBm
	4	-8 dBm
	5	-12 dBm
	6	-16 dBm
	7	-20 dBm
	8	-40 dBm
Description	Take effect immediately and save after power failure	

6.4.24 AT+SLEEP Enter Sleep Command Immediately

Command		Response
Set	AT+SLEEP	+OK
parameter	No	
Description	Effective immediately.	

6.4.25 AT+LOGMSG Operation Status Output

Command		Response
Inquire	AT+LOGMSG?	+OK=[para]

Set	AT+LOGMSG =[para]	+OK: success +ERR=[NUM]: error
parameter	para (ASCII)	description
	0	Off (default)
	1	Turn on
Description	1. Take effect immediately, save when power off.	

6.4.26 AT+FNAME Name Filtering

Command		Response	
Inquire	AT+FNAME?	+OK=[en],[name]	
Set	AT+FNAME =[en],[name]	+OK: success +ERR=[NUM]: error	
parameter	En	En	Description
		0	Disallow name filtering
		1	Enable name filtering
	Name	name. Used for name filtering during host scan connection;	
Description	1. Take effect immediately, save when power off.		

6.4.27 AT+FRSSI Signal Strength Filtering

Command		Response	
Inquire	AT+FRSSI?	+OK=[en],[pwr]	
Set	AT+FRSSI =[en],[pwr]	+OK: success +ERR=[NUM]: error	
parameter	En	En	Description
		0	Disable signal strength filtering

		1	Use signal strength filtering
	pwr	Signal strength. Value range: -128 to 127	
Description	1. Take effect immediately, save when power off. 2. Only the master role is valid, but the slave can also be configured;		
Sample	<ul style="list-style-type: none"> ➤ Set the signal strength filter to -90; AT+FRSSI=1, -90 ➤ Turn off signal strength filtering. AT+FRSSI=0,-90. 		

6.4.28 AT+PHY BLE PHY Instructions

	Command	Response
Inquire	AT+PHY?	+OK=[phy]
Set	AT+PHY =[phy]	+OK: success +ERR=[NUM]: error
parameter	Phy	Description
	0	1M PHY
	1	2M PHY
	2	CODE PHY
Description	Take effect immediately, save when power off. 1. ble can only broadcast on 1M and code PHY; 2. Long rang support is to use code phy to broadcast and connect. Communication under this phy can greatly increase the communication distance and reduce the communication rate at the same time;	

7. Quick start

Recommended software for debugging/testing:

- PC serial port tool - SSCOM.exe;
- Mobile ble debugging APP - nRF connect.

7.1 Quick Guide to Configuration Mode

7.1.1 Serial port configuration

- Confirm whether the module is currently in configuration mode (if not connected, the module can be configured, if it is connected, the mod pin needs to be set to low level).
- Set SSCOM string related configuration (default configuration: 115200, 8, 1, none, no flow null), as shown in Figure 7 1SSCOM parameter configuration diagram;

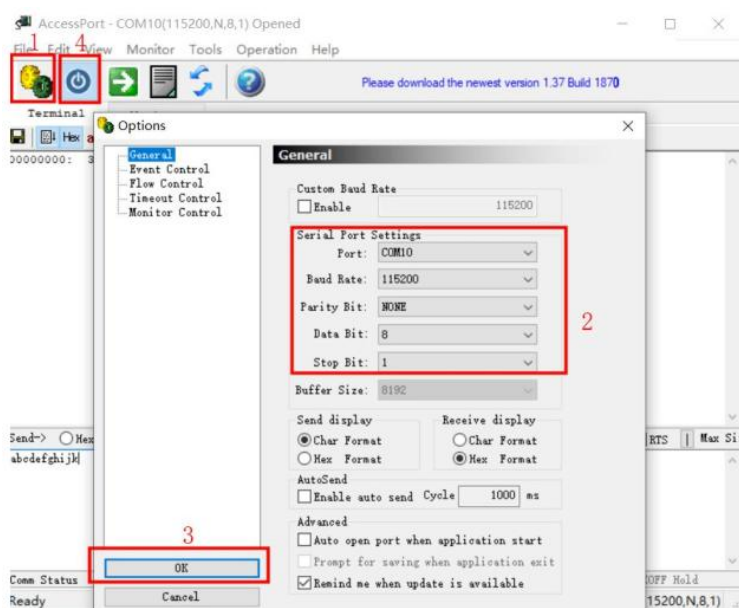

Chart 7 1SSCOM parameter configuration diagram

- Configure the module according to the instructions shown in the 6.4 instruction list;

7.1.2 Air configuration

- The air configuration can only be used when the module is a slave.

- Open the app "nRF connect", start scanning the device, and find the "E104-BT5011A" connection module;

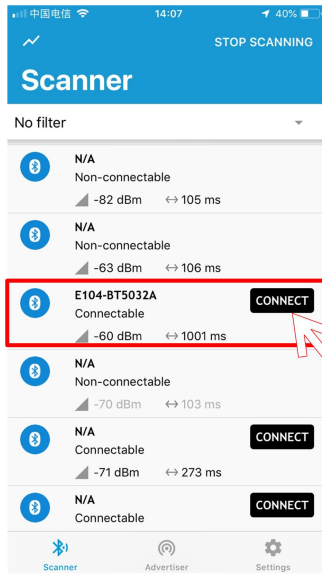

Chart 7 2 nRF connect scan list chart

- Open the uuid fff0 service and enable the configuration channel notify;

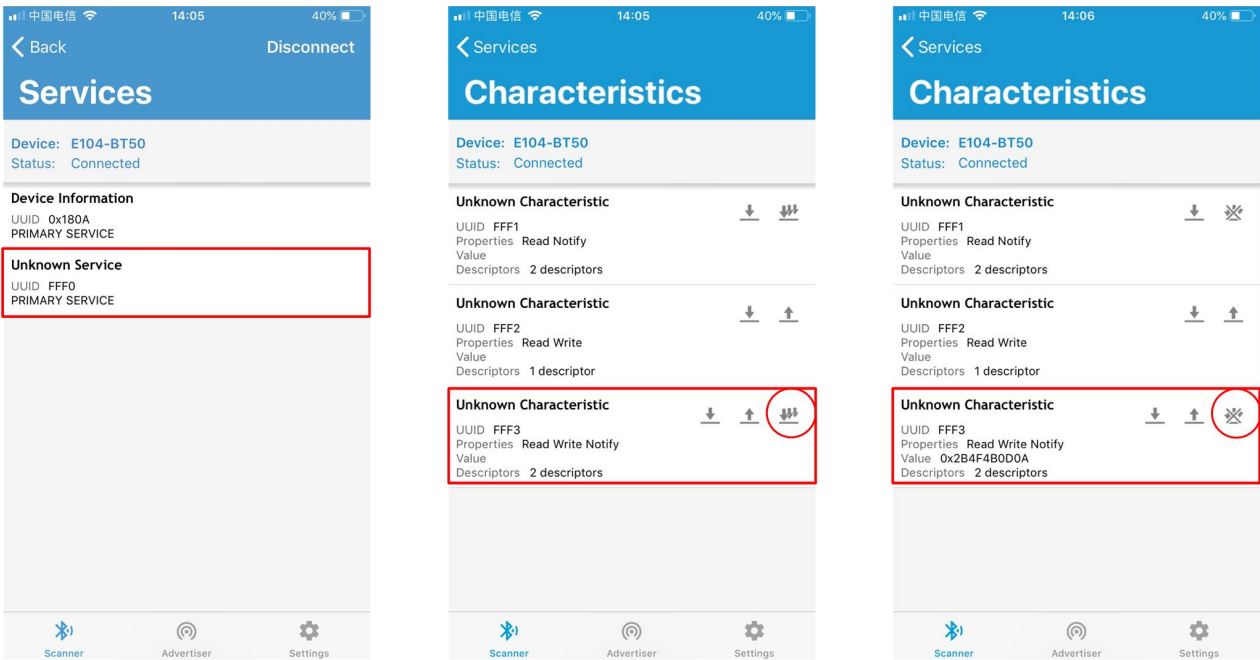

Chart 7 3 nRF connect connection and enable notification

- Send the authentication command (at+auth=12345), the module returns "0x2befeb0d0a (+OK\r\n)" to indicate that the authentication is successful;

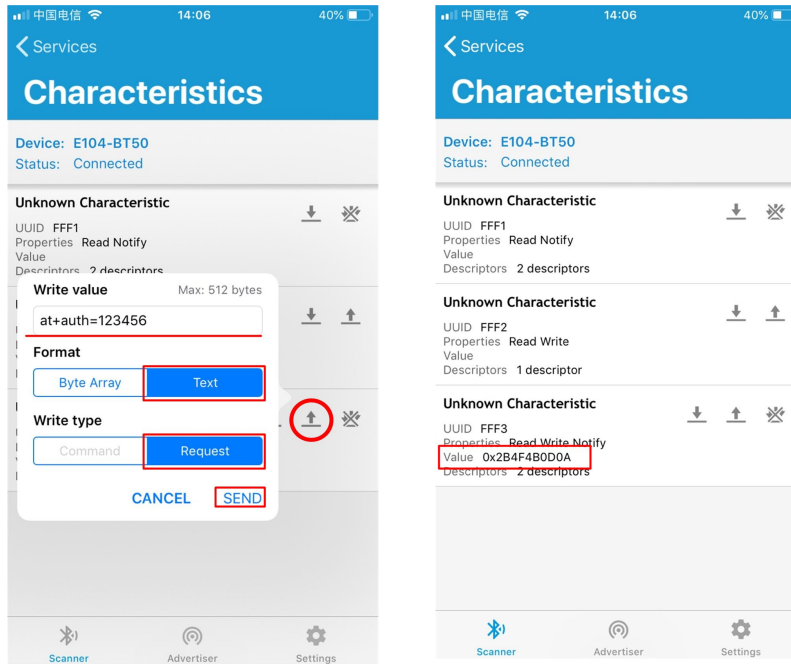

Chart 7 4 Aerial configuration certification chart

- Configure the module according to the instructions shown in the 6.4 instruction list;

7.2 Data transmission

For data transmission related instructions, see 5.3 Data Transmission Mode.

- Test Conditions:
 - Configure one module as the master and one as the slave as described in the 7.1 Configuration Mode Quick Use Guide;
 - Test software: SSCOM.
 - Other parameters are the default configuration.

7.2.1 Data transparent transmission

1. Power on the module. Enable logmsg printing for master and slave (at+logmsg=1);
2. Print "STA:connected" after successful connection. The LINK pin is low. (As shown in Figure 7: 5 data transparent transmission diagram)
3. The master sends the data "0123456789" to the slave, and the slave receives the data as "0123456789" (as shown in Figure 7: 5 data transparent transmission diagram);
4. The slave sends data "abcdefghijk" to the host, and the host receives the data as "abcdefghijk" (as shown in Figure 7: 5

data transparent transmission diagram);

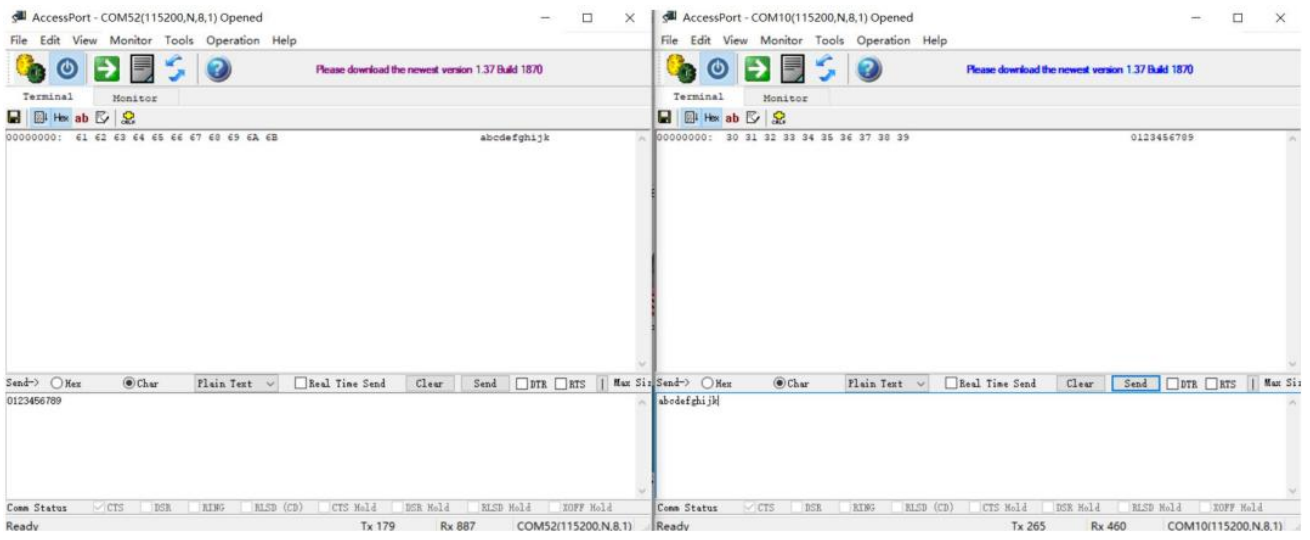

Chart 7 5 Data Transparent Transmission Diagram

8. Hardware design

- It is recommended to use a DC stabilized power supply. The power supply ripple factor is as small as possible and the module needs to be reliably grounded.
- Please pay attention to the correct connection of the positive and negative poles of the power supply.
- Reverse connection may cause permanent damage to the module;
- Please check the power supply to ensure it is within the recommended voltage otherwise when it exceeds the maximum value the module will be permanently damaged;
- Please check the stability of the power supply, the voltage cannot be fluctuated frequently;
- When designing the power supply circuit for the module, it is often recommended to reserve more than 30% of the margin, so the whole machine is beneficial for long-term stable operation.
- The module should be as far away as possible from the power supply, transformers, high-frequency wiring and other parts with large electromagnetic interference
- High-frequency digital routing, high-frequency analog routing, and power routing must be avoided under the module. If it is necessary to pass through the module, assume that the module is soldered to the Top Layer, and the copper is spread on the Top Layer of the module contact part(well grounded), it must be close to the digital part of the module and routed in the Bottom Layer;
- Assuming the module is soldered or placed over the Top Layer, it is wrong to randomly route over the Bottom Layer or other layers, which will affect the module's spurs and receiving sensitivity to varying degrees.
- It is assumed that there are devices with large electromagnetic interference around the module that will greatly affect the performance. It is recommended to keep them away from the module according to the strength of the interference. If necessary, appropriate isolation and shielding can be done;
- Assume that there are traces with large electromagnetic interference (high-frequency digital, high-frequency analog, power traces) around the module that will greatly affect the performance of the module. It is recommended to stay away from the module according to the strength of the interference. If necessary, appropriate isolation and shielding can be done.
- Try to stay away from some physical layers such as TTL protocol at 2.4GHz , for example: USB3.0;
- The mounting structure of antenna has a great influence on the performance of the module. It is necessary to ensure that the antenna is exposed, preferably vertically upward. When the module is mounted inside the case,

use a good antenna extension cable to extend the antenna to the outside;

- The antenna must not be installed inside the metal case, which will cause the transmission distance to be greatly weakened.

9. FAQ

9.1 Communication range is too short

- The communication distance will be affected when obstacle exists.
- Data lose rate will be affected by temperature, humidity and co-channel interference.
- The ground will absorb and reflect wireless radio wave, so the performance will be poor when testing near ground.
- Sea water has great ability in absorbing wireless radio wave, so performance will be poor when testing near the sea.
- The signal will be affected when the antenna is near metal object or put in a metal case.
- Power register was set incorrectly, air data rate is set as too high (the higher the air data rate, the shorter the distance).
- The power supply low voltage under room temperature is lower than 2.5V, the lower the voltage, the lower the transmitting power.
- Due to antenna quality or poor matching between antenna and module.

9.2 Module is easy to damage

- Please check the power supply source, ensure it is 2.0V~3.6V, voltage higher than 3.6V will damage the module.
- Please check the stability of power source, the voltage cannot fluctuate too much.
- Please make sure antistatic measure are taken when installing and using, high frequency devices have electrostatic susceptibility.
- Please ensure the humidity is within limited range, some parts are sensitive to humidity.
- Please avoid using modules under too high or too low temperature.

9.3 Bit error rate is too high

- There are co-channel signal interference nearby, please be away from interference sources or modify frequency and channel to avoid interference.
- Poor power supply may cause messy code. Make sure that the power supply is reliable.
- The extension line and feeder quality are poor or too long, so the bit error rate is high

10. Production Guidance

10.1 Reflow Soldering Temperature

Profile Feature	Curve characteristics	Sn-Pb Assembly	Pb-Free Assembly
Solder Paste	Solder paste	Sn63/Pb37	Sn96.5/Ag3/Cu0.5
Preheat Temperature min (T _{min})	Min preheating temp.	100°C	150°C
Preheat temperature max (T _{max})	Mx preheating temp.	150°C	200°C
Preheat Time (T _{min} to T _{max})(ts)	Preheating time	60-120 sec	60-120 sec
Average ramp-up rate(T _{max} to T _p)	Average ramp-up rate	3°C/second max	3°C/second max
Liquidous Temperature (TL)	Liquid phase temp.	183°C	217°C
Time (t _L) Maintained Above (TL)	Time below liquid phase line	60-90 sec	30-90 sec
Peak temperature (T _p)	Peak temp.	220-235°C	230-250°C
Average ramp-down rate (T _p to T _{max})	Average ramp-down rate	6°C/second max	6°C/second max
Time 25°C to peak temperature	Time to peak temperature for 25°C	6 minutes max	8 minutes max

Chart 10- 1 Reflow soldering temperature

10.2 Reflow Soldering Curve

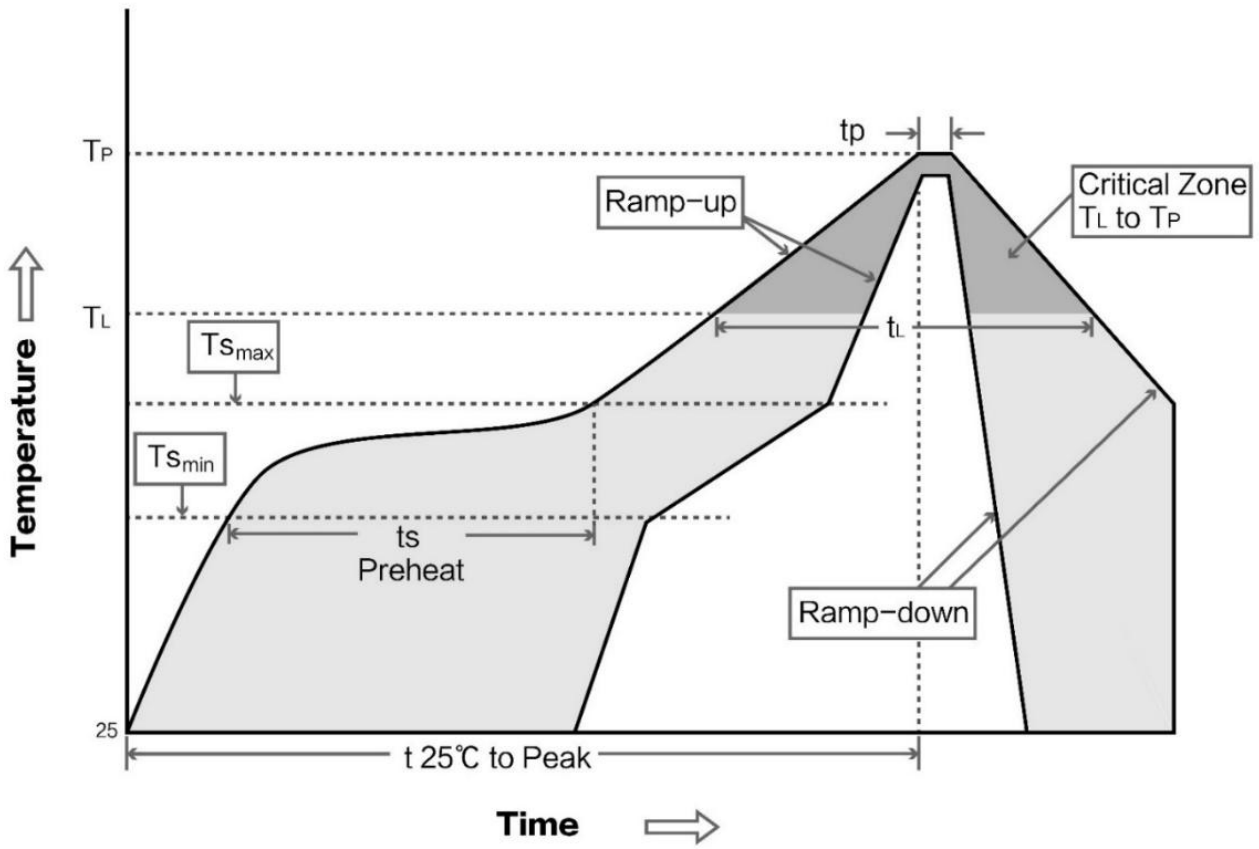

Chart 10 -2 Reflow soldering curve

11. Related product

Model NO.	RF IC	Frequency Hz	TX POWER dBm	Interface	Protocol BLE	Size mm	Antenna	Function
E72-2G4M05S1 B	CC2640	2.4G	5	I/O	4.2	17.5*28.7	PCB/IPX	Hardware module, requires secondary development
E73-2G4M04S1 A	nRF52810	2.4G	4	I/O	4.2/5.0	17.5*28.7	PCB/IPX	Hardware module, requires secondary development
E73-2G4M04S1 B	nRF52832	2.4G	4	I/O	4.2/5.0	17.5*28.7	PCB/IPX	Hardware module, requires secondary development
E73-2G4M08S1 C	nRF52840	2.4G	8	I/O	4.2/5.0	13*18	PCB/IPX	Hardware module, requires secondary

								development
E73-2G4M04S1 D	nRF5182 2	2.4G	4	I/O	4.2	17.5*28. 7	PCB/IPX	Hardware module, requires secondary development
E104-BT01	CC2541	2.4G	0	I/O	4.0	14*22	PCB	Hardware module, requires secondary development
E104-BT02	DA1458 0	2.4G	0	TTL	4.2	14*22	PCB	Ultra-low power High speed, sniff
E72-2G4M04S2 B	CC2640	2.4G	2	TTL	4.2	14*23	PCB/IPX	Built-in ARM dual core Multiple role
E104-2G4U04A	CC2540	2.4G	0	USB	4.0	18*59	PCB	Dongle Protocol Analyzer
E104-BT5010A	nRF5281 0	2.4G	0	UART	5.0	11.5 * 16	Ceramic antenna	Low power, transparent

								transmissio n
--	--	--	--	--	--	--	--	------------------

Chart 11- 1 Related model list

12. Package for bulk order

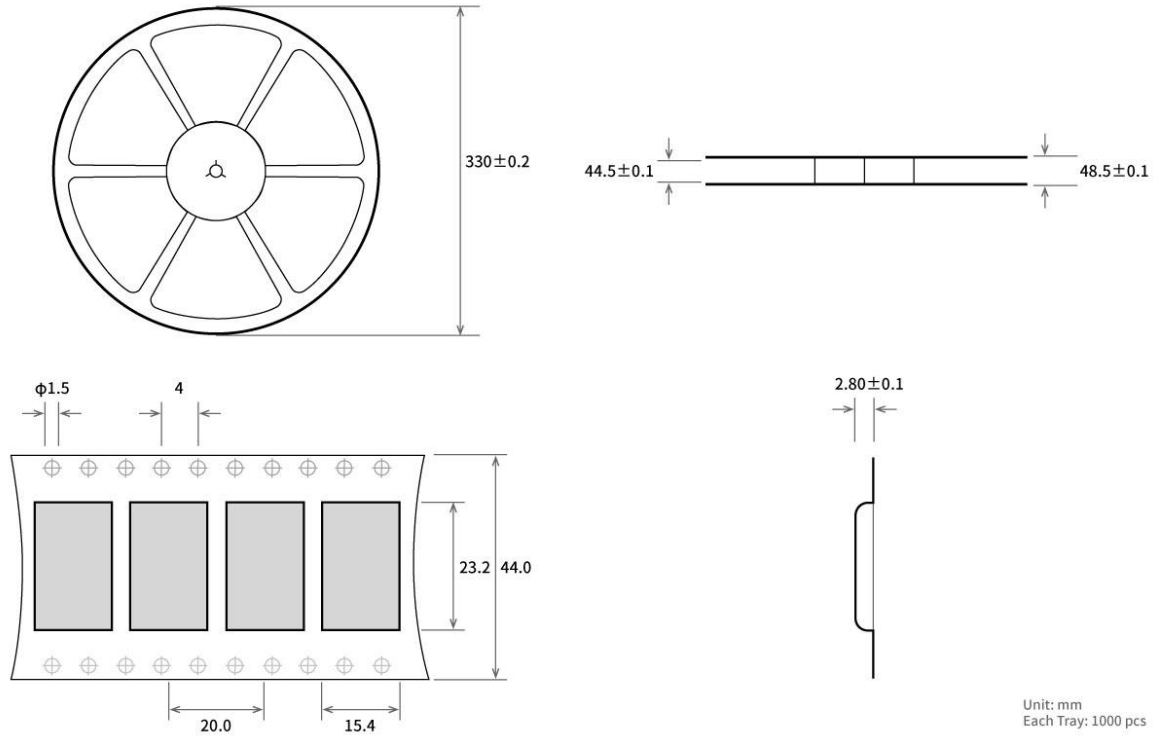

Chart 12- 1 Packaging Chart

13.Reversion History

version	Revision date	Revision description	Issued by
1.0	2020-08-07	initial version	huaa
1.2	2022-8-2	Bug fixes	Yan

14.About Us

Website: www.ebyte.com Sales: info@cdebyte.com Support: support@cdebyte.com

Tel: +86-28-61399028 Ext. 812 Fax: +86-28-64146160

(office) Address : Building B5, Mould Industrial Park, 199# Xi-Qu Ave, West High-tech Zone, Chengdu, 611731,
Sichuan, China

(Production + Q&A + Warehouse)Address : Building B2, Mould Industrial Park, 199# Xi-Qu Ave, West High-tech Zone,
Chengdu, 611731, Sichuan, China



Chengdu Ebyte Electronic Technology Co.,Ltd.