

TPS56220x 采用 6 引脚 SOT-23 封装的 4.5V 至 17V 输入、2A 同步降压稳压器

1 特性

- TPS562201 和 TPS562208 2A 转换器集成有 140mΩ 和 84mΩ 场效应晶体管 (FET)
- D-CAP2™ 模式控制，用于快速瞬态响应
- 输入电压范围：4.5V 至 17V
- 输出电压范围：0.76V 至 7V
- 脉冲跳跃模式 (TPS562201) 或持续电流模式 (TPS562208)
- 580kHz 开关频率
- 少于 10μA 的低关断电流
- 2% 反馈电压精度 (25°C)
- 从预偏置输出电压中启动
- 逐周期过流限制
- 断续模式过流保护
- 非锁存欠压保护 (UVP) 和热关断 (TSD) 保护
- 固定软启动时间：1.0ms

2 应用

- 数字电视电源
- 高清 Blu-Ray™ 光盘播放器
- 网络家庭终端设备
- 数字机顶盒 (STB)
- 安全监控

3 说明

TPS562201 和 TPS562208 是采用 SOT-23 封装的简单易用型 2A 同步降压转换器。

此器件被优化为使用尽可能少的外部组件即可运行，并且可以实现低待机电流。

这些开关模式电源 (SMPS) 器件采用 D-CAP2 模式控制，从而提供快速瞬态响应，并且在无需外部补偿组件的情况下支持诸如高分子聚合物等低等效串联电阻 (ESR) 输出电容器以及超低 ESR 陶瓷电容器。

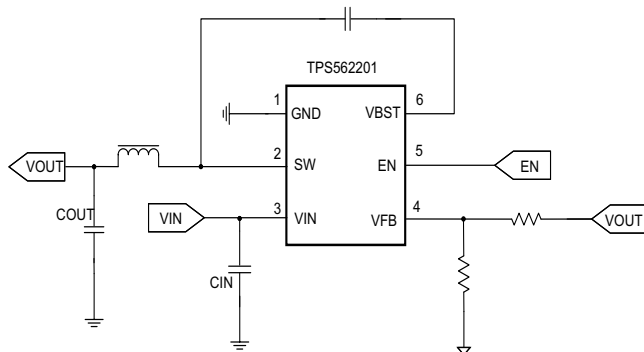
TPS562201 可在脉冲跳跃模式下运行，从而能在轻载运行期间保持高效率。TPS562201 和 TPS562208 采用 6 引脚 1.6mm × 2.9mm SOT (DDC) 封装，额定结温范围为 -40°C 至 125°C。

器件信息⁽¹⁾

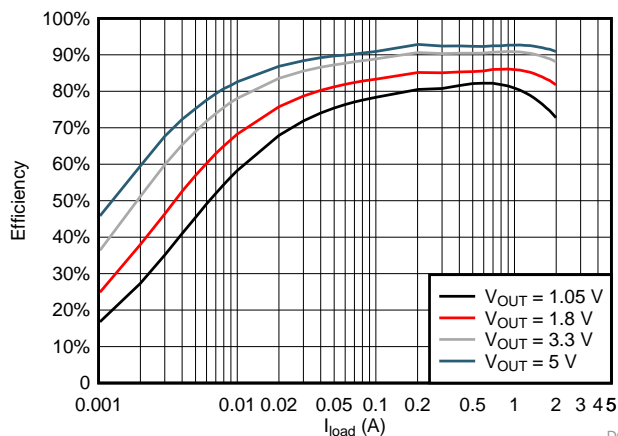
器件型号	封装	封装尺寸 (标称值)
TPS562201 TPS562208	SOT (6)	1.60mm x 2.90mm

(1) 要了解所有可用封装，请见数据表末尾的可订购产品附录。

简化电路原理图



TPS563201 效率



D021



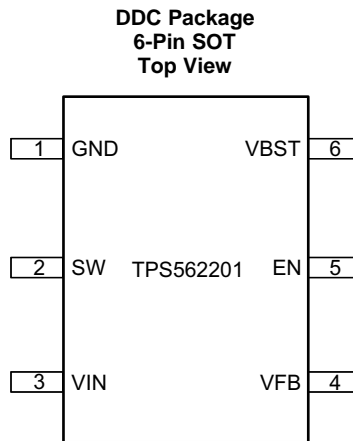
目录

<p>1 特性 1</p> <p>2 应用 1</p> <p>3 说明 1</p> <p>4 修订历史记录 2</p> <p>5 Pin Configuration and Functions 3</p> <p>6 Specifications 4</p> <p> 6.1 Absolute Maximum Ratings 4</p> <p> 6.2 ESD Ratings 4</p> <p> 6.3 Recommended Operating Conditions 4</p> <p> 6.4 Thermal Information 4</p> <p> 6.5 Electrical Characteristics 5</p> <p> 6.6 Typical Characteristics 6</p> <p>7 Detailed Description 9</p> <p> 7.1 Overview 9</p> <p> 7.2 Functional Block Diagram 9</p> <p> 7.3 Feature Description 9</p>	<p> 7.4 Device Functional Modes 11</p> <p>8 Application and Implementation 12</p> <p> 8.1 Application Information 12</p> <p> 8.2 Typical Application 12</p> <p>9 Power Supply Recommendations 17</p> <p>10 Layout 17</p> <p> 10.1 Layout Guidelines 17</p> <p> 10.2 Layout Example 17</p> <p>11 器件和文档支持 18</p> <p> 11.1 相关链接 18</p> <p> 11.2 社区资源 18</p> <p> 11.3 商标 18</p> <p> 11.4 静电放电警告 18</p> <p> 11.5 Glossary 18</p> <p>12 机械、封装和可订购信息 18</p>
---	---

4 修订历史记录

日期	修订版本	注释
2015 年 12 月	*	首次发布。

5 Pin Configuration and Functions



Pin Functions

PIN		DESCRIPTION
NAME	NO.	
GND	1	Ground pin Source terminal of low-side power NFET as well as the ground terminal for controller circuit. Connect sensitive VFB to this GND at a single point.
SW	2	Switch node connection between high-side NFET and low-side NFET.
VIN	3	Input voltage supply pin. The drain terminal of high-side power NFET.
VFB	4	Converter feedback input. Connect to output voltage with feedback resistor divider.
EN	5	Enable input control. Active high and must be pulled up to enable the device.
VBST	6	Supply input for the high-side NFET gate drive circuit. Connect 0.1- μ F capacitor between VBST and SW pins.

6 Specifications

6.1 Absolute Maximum Ratings

 over operating free-air temperature range (unless otherwise noted)⁽¹⁾

		MIN	MAX	UNIT
Input voltage	VIN, EN	-0.3	19	V
	VBST	-0.3	25	V
	VBST (10-ns transient)	-0.3	27	V
	VBST (vs SW)	-0.3	6.5	V
	VFB	-0.3	6.5	V
	SW	-2	19	V
	SW (10 ns transient)	-3.5	21	V
Operating junction temperature, T _J		-40	150	°C
Storage temperature, T _{stg}		-55	150	°C

- (1) Stresses beyond those listed under *Absolute Maximum Ratings* may cause permanent damage to the device. These are stress ratings only, which do not imply functional operation of the device at these or any other conditions beyond those indicated under *Recommended Operating Conditions*. Exposure to absolute-maximum-rated conditions for extended periods may affect device reliability.

6.2 ESD Ratings

		VALUE	UNIT
V _(ESD)	Electrostatic discharge	Human-body model (HBM), per ANSI/ESDA/JEDEC JS-001 ⁽¹⁾	±3000
		Charged-device model (CDM), per JEDEC specification JESD22-C101 ⁽²⁾	±1500

- (1) JEDEC document JEP155 states that 500-V HBM allows safe manufacturing with a standard ESD control process.
 (2) JEDEC document JEP157 states that 250-V CDM allows safe manufacturing with a standard ESD control process.

6.3 Recommended Operating Conditions

over operating free-air temperature range (unless otherwise noted)

		MIN	MAX	UNIT	
V _{IN}	Supply input voltage	4.5	17	V	
V _I	Input voltage	VBST	-0.1	23	V
		VBST (10-ns transient)	-0.1	26	
		VBST(vs SW)	-0.1	6.0	
		EN	-0.1	17	
		VFB	-0.1	5.5	
		SW	-1.8	17	
		SW (10 ns transient)	-3.5	20	
T _J	Operating junction temperature	-40	125	°C	

6.4 Thermal Information

THERMAL METRIC ⁽¹⁾		TPS562201 and TPS562208	UNIT
		DDC (SOT)	
		6 PINS	
R _{θJA}	Junction-to-ambient thermal resistance	90.8	°C/W
R _{θJC(top)}	Junction-to-case (top) thermal resistance	42.3	°C/W
R _{θJB}	Junction-to-board thermal resistance	16.3	°C/W
ψ _{JT}	Junction-to-top characterization parameter	2.6	°C/W
ψ _{JB}	Junction-to-board characterization parameter	16.3	°C/W

- (1) For more information about traditional and new thermal metrics, see the *Semiconductor and IC Package Thermal Metrics* application report, [SPRA953](#).

6.5 Electrical Characteristics

 $T_J = -40^{\circ}\text{C}$ to 125°C , $V = 12\text{ V}$ (unless otherwise noted)

PARAMETER		TEST CONDITIONS	MIN	TYP	MAX	UNIT
SUPPLY CURRENT						
I_{VIN}	Operating – non-switching supply current	V_{IN} current, $EN = 5\text{ V}$, $V_{FB} = 0.8\text{ V}$	TPS562201	380	520	μA
			TPS562208	590	750	
I_{VINSDN}	Shutdown supply current	V_{IN} current, $EN = 0\text{ V}$		1	10	μA
LOGIC THRESHOLD						
V_{ENH}	EN high-level input voltage	EN	1.6			V
V_{ENL}	EN low-level input voltage	EN			0.8	V
R_{EN}	EN pin resistance to GND	$V_{EN} = 12\text{ V}$	225	400	900	k Ω
VFB VOLTAGE AND DISCHARGE RESISTANCE						
	VFB threshold voltage	$V_O = 1.05\text{ V}$, $I_O = 10\text{ mA}$, Eco-mode™ operation		774		mV
V_{FBTH}	VFB threshold voltage	$V_O = 1.05\text{ V}$, continuous mode operation	749	768	787	mV
I_{VFB}	VFB input current	$V_{FB} = 0.8\text{ V}$		0	± 0.1	μA
MOSFET						
$R_{DS(on)h}$	High-side switch resistance	$T_A = 25^{\circ}\text{C}$, $V_{BST} - SW = 5.5\text{ V}$		140		m Ω
$R_{DS(on)l}$	Low-side switch resistance	$T_A = 25^{\circ}\text{C}$		84		m Ω
CURRENT LIMIT						
I_{ocL}	Current limit	DC current, $V_{OUT} = 1.05\text{ V}$, $L1 = 2.2\text{ }\mu\text{H}$	2.4	3.2	4.0	A
THERMAL SHUTDOWN						
T_{SDN}	Thermal shutdown threshold ⁽¹⁾	Shutdown temperature		160		$^{\circ}\text{C}$
		Hysteresis		25		
ON-TIME TIMER CONTROL						
$t_{OFF(MIN)}$	Minimum off time	$V_{FB} = 0.5\text{ V}$		220	310	ns
SOFT START						
t_{ss}	Soft-start time	Internal soft-start time		1.0		ms
	Frequency					
F_{sw}	Switching frequency	$V_{IN} = 12\text{ V}$, $V_O = 1.05\text{ V}$, FCCM mode		580		kHz
OUTPUT UNDERVOLTAGE AND OVERVOLTAGE PROTECTION						
V_{UVP}	Output UVP threshold	Hiccup detect ($H > L$)		65%		
T_{HICCUP_WAIT}	Hiccup wait time			1.8		ms
T_{HICCUP_RE}	Hiccup time before restart			15		ms
UVLO						
UVLO	UVLO threshold	Wake up V_{IN} voltage		4.0	4.3	V
		Shut down V_{IN} voltage	3.3	3.6		
		Hysteresis V_{IN} voltage		0.4		

(1) Not production tested

6.6 Typical Characteristics

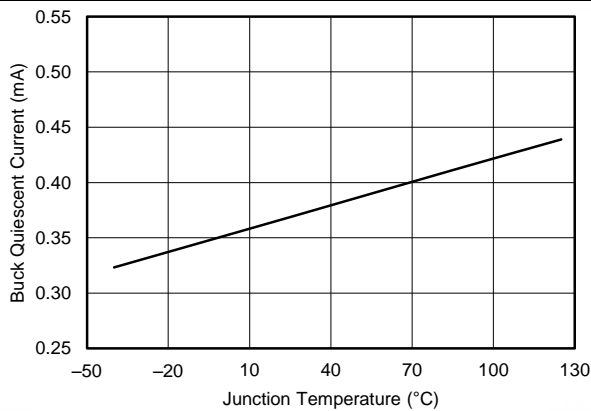
 $V_{IN} = 12\text{ V}$ (unless otherwise noted)


Figure 1. TPS562201 Supply Current vs Junction Temperature

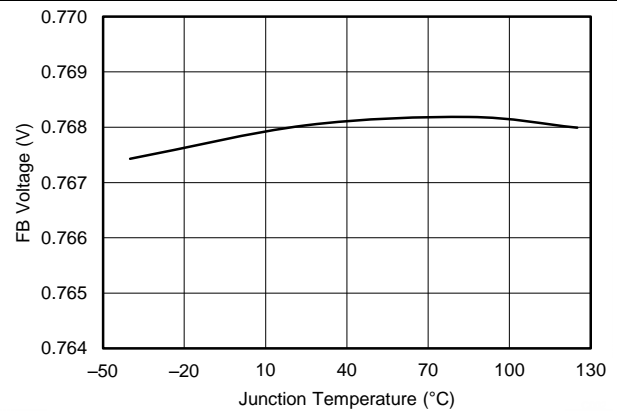


Figure 2. VFB Voltage vs Junction Temperature

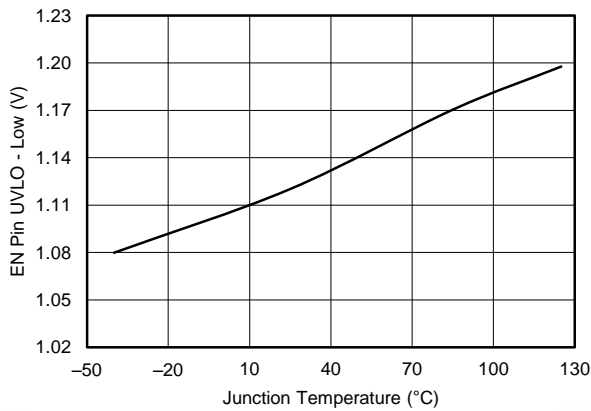


Figure 3. EN Pin UVLO Low Voltage vs Junction Temperature

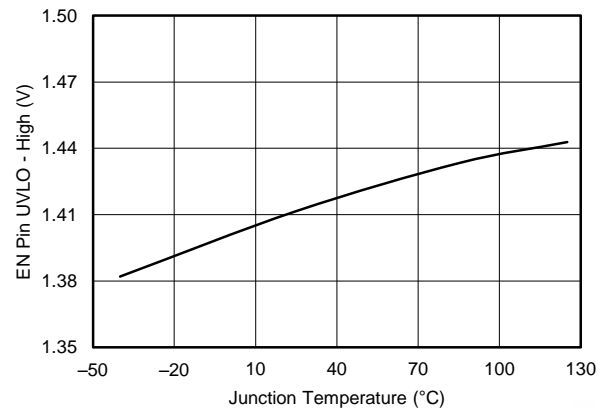


Figure 4. EN Pin UVLO High Voltage vs Junction Temperature

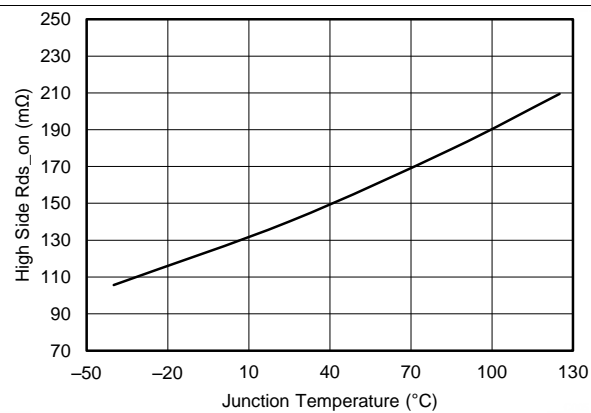


Figure 5. High-Side R_{ds-on} vs Junction Temperature

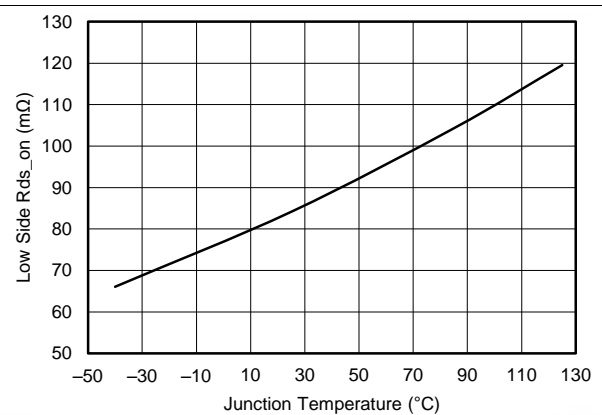


Figure 6. Low-Side R_{ds-on} vs Junction Temperature

Typical Characteristics (continued)

$V_{IN} = 12\text{ V}$ (unless otherwise noted)

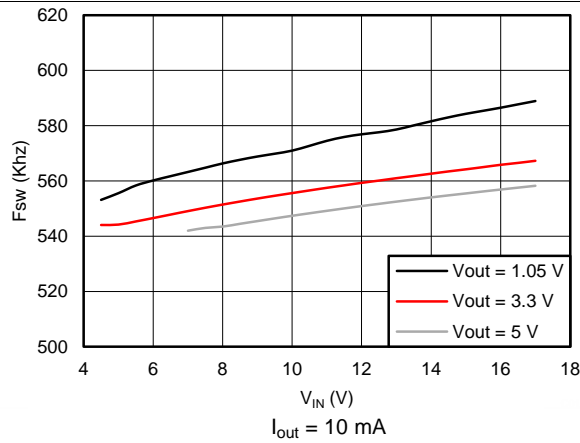


Figure 7. TPS562208 Switching Frequency vs Input Voltage

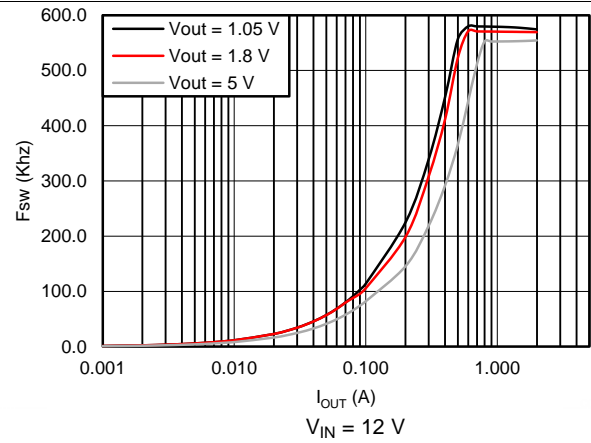


Figure 8. TPS562201 Switching Frequency vs Output Current

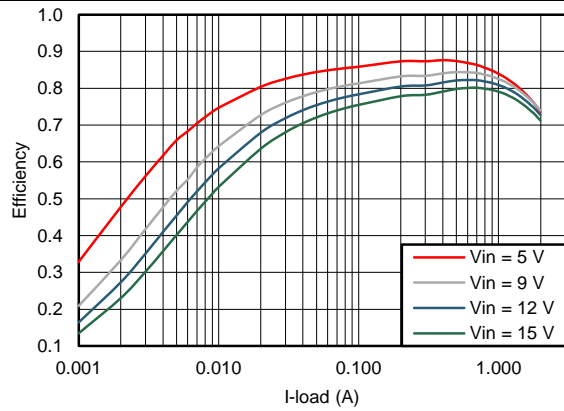


Figure 9. TPS562201 $V_{OUT} = 1.05\text{ V}$ Efficiency, $L = 2.2\ \mu\text{H}$

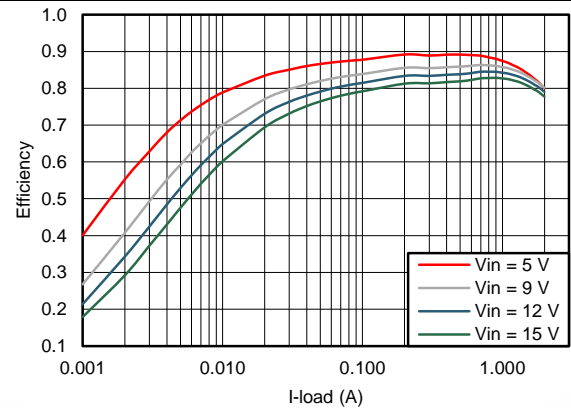


Figure 10. TPS562201 $V_{OUT} = 1.5\text{ V}$ Efficiency, $L = 2.2\ \mu\text{H}$

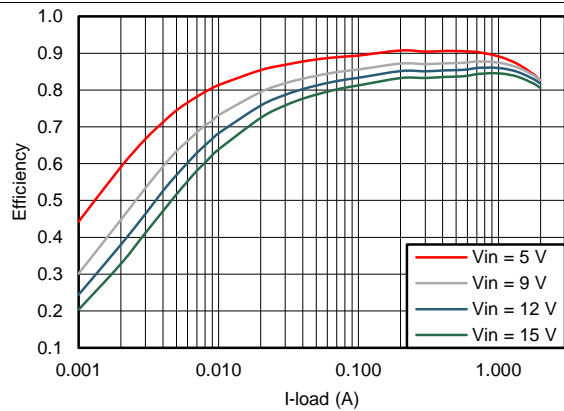


Figure 11. TPS562201 $V_{OUT} = 1.8\text{ V}$ Efficiency, $L = 2.2\ \mu\text{H}$

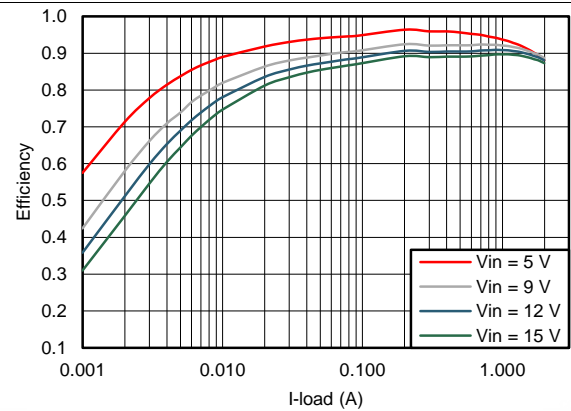
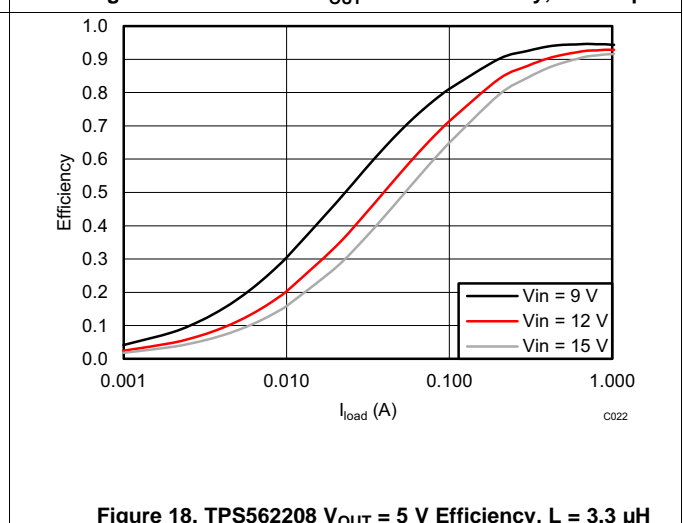
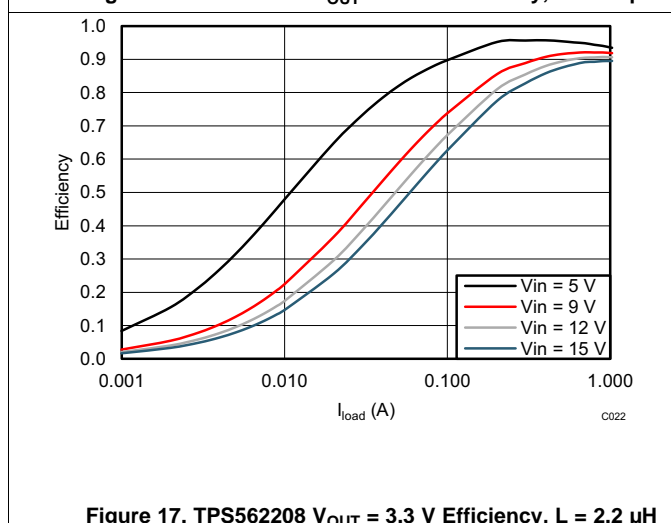
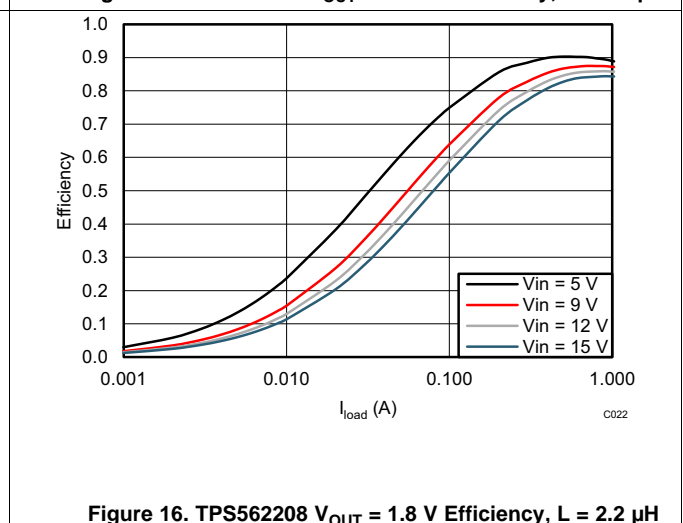
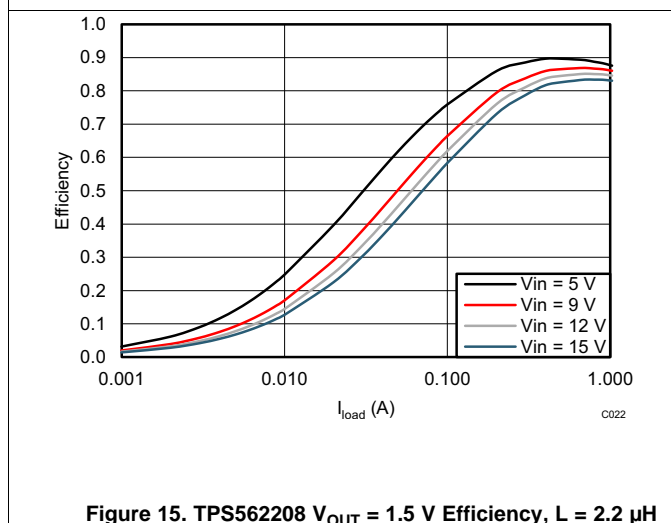
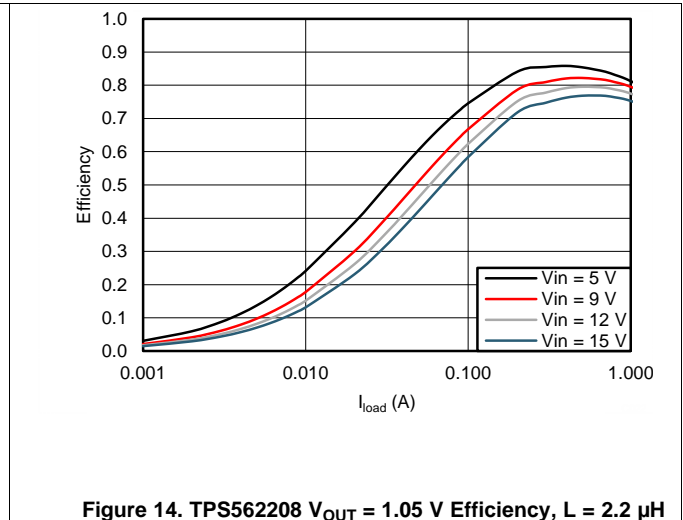
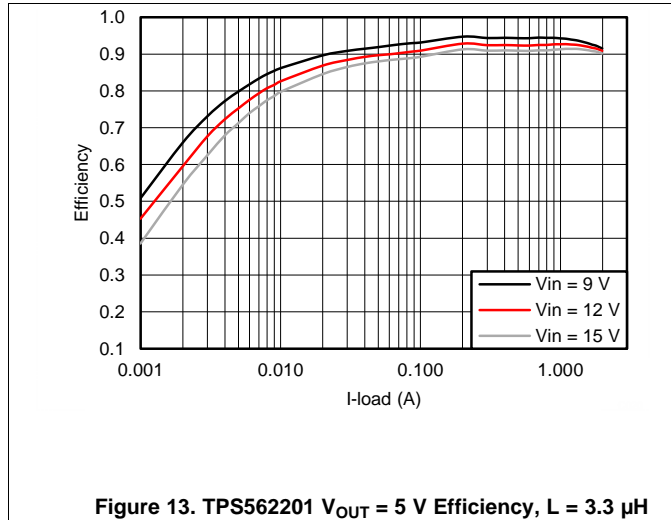


Figure 12. TPS562201 $V_{OUT} = 3.3\text{ V}$ Efficiency, $L = 3.3\ \mu\text{H}$

Typical Characteristics (continued)

$V_{IN} = 12\text{ V}$ (unless otherwise noted)

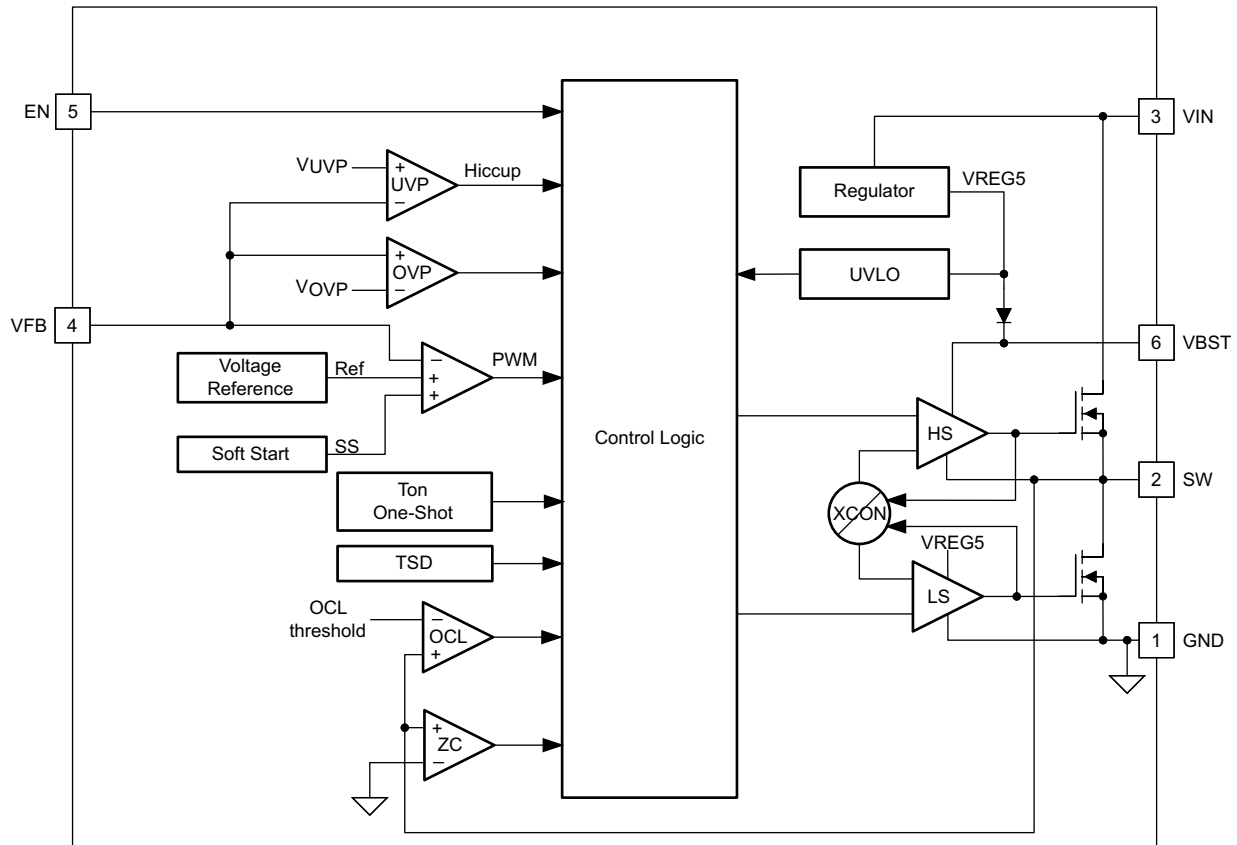


7 Detailed Description

7.1 Overview

The TPS562201 and TPS562208 are 2-A synchronous step-down converters. The proprietary D-CAP2 mode control supports low ESR output capacitors such as specialty polymer capacitors and multi-layer ceramic capacitors without complex external compensation circuits. The fast transient response of D-CAP2 mode control can reduce the output capacitance required to meet a specific level of performance.

7.2 Functional Block Diagram



7.3 Feature Description

7.3.1 Adaptive On-Time Control and PWM Operation

The main control loop of the TPS562201 is adaptive on-time pulse width modulation (PWM) controller that supports a proprietary D-CAP2 mode control. The D-CAP2 mode control combines adaptive on-time control with an internal compensation circuit for pseudo-fixed frequency and low external component count configuration with both low ESR and ceramic output capacitors. It is stable even with virtually no ripple at the output.

At the beginning of each cycle, the high-side MOSFET is turned on. This MOSFET is turned off after internal one shot timer expires. This one shot duration is set proportional to the converter input voltage, V_{IN} , and inversely proportional to the output voltage, V_O , to maintain a pseudo-fixed frequency over the input voltage range, hence it is called adaptive on-time control. The one-shot timer is reset and the high-side MOSFET is turned on again when the feedback voltage falls below the reference voltage. An internal ramp is added to reference voltage to simulate output ripple, eliminating the need for ESR induced output ripple from D-CAP2 mode control.

Feature Description (continued)

7.3.2 Pulse Skip Control (TPS562201)

The TPS562201 and TPS562208 are designed with Advanced Eco-mode to maintain high light load efficiency. As the output current decreases from heavy load condition, the inductor current is also reduced and eventually comes to point that its rippled valley touches zero level, which is the boundary between continuous conduction and discontinuous conduction modes. The rectifying MOSFET is turned off when the zero inductor current is detected. As the load current further decreases the converter runs into discontinuous conduction mode. The on-time is kept almost the same as it was in the continuous conduction mode so that it takes longer time to discharge the output capacitor with smaller load current to the level of the reference voltage. This makes the switching frequency lower, proportional to the load current, and keeps the light load efficiency high. The transition point to the light load operation $I_{OUT(LL)}$ current can be calculated in [Equation 1](#).

$$I_{OUT(LL)} = \frac{1}{2 \times L \times f_{SW}} \times \frac{(V_{IN} - V_{OUT}) \times V_{OUT}}{V_{IN}} \quad (1)$$

7.3.3 Soft Start and Pre-Biased Soft Start

The TPS562201 and TPS562208 have an internal 1.0-ms soft-start. When the EN pin becomes high, the internal soft-start function begins ramping up the reference voltage to the PWM comparator. If the output capacitor is pre-biased at startup, the devices initiate switching and start ramping up only after the internal reference voltage becomes greater than the feedback voltage VFB. This scheme ensures that the converters ramp up smoothly into regulation point.

7.3.4 Current Protection

The output over-current limit (OCL) is implemented using a cycle-by-cycle valley detect control circuit. The switch current is monitored during the OFF state by measuring the low-side FET drain to source voltage. This voltage is proportional to the switch current. To improve accuracy, the voltage sensing is temperature compensated.

During the on time of the high-side FET switch, the switch current increases at a linear rate determined by V_{in} , V_{out} , the on-time and the output inductor value. During the on time of the low-side FET switch, this current decreases linearly. The average value of the switch current is the load current I_{out} . If the monitored current is above the OCL level, the converter maintains low-side FET on and delays the creation of a new set pulse, even the voltage feedback loop requires one, until the current level becomes OCL level or lower. In subsequent switching cycles, the on-time is set to a fixed value and the current is monitored in the same manner.

There are some important considerations for this type of over-current protection. The load current is higher than the overcurrent threshold by one half of the peak-to-peak inductor ripple current. Also, when the current is being limited, the output voltage tends to fall as the demanded load current may be higher than the current available from the converter. This may cause the output voltage to fall. When the VFB voltage falls below the UVP threshold voltage, the UVP comparator detects it. And then, the device will shut down after the UVP delay time (typically 24 μ s) and restart after the hiccup time (typically 15 ms).

When the over current condition is removed, the output voltage returns to the regulated value.

7.3.5 Undervoltage Lockout (UVLO) Protection

UVLO protection monitors the internal regulator voltage. When the voltage is lower than UVLO threshold voltage, the device is shut off. This protection is non-latching.

7.3.6 Thermal Shutdown

The device monitors the temperature of itself. If the temperature exceeds the threshold value (typically 160°C), the device is shut off. This is a non-latch protection.

7.4 Device Functional Modes

7.4.1 Normal Operation

When the input voltage is above the UVLO threshold and the EN voltage is above the enable threshold, the TPS562200 can operate in their normal switching modes. Normal continuous conduction mode (CCM) occurs when the minimum switch current is above 0 A. In CCM, the TPS562208 operates at a quasi-fixed frequency of 580 kHz.

7.4.2 Eco-mode Operation

When the TPS562201 and TPS562208 are in the normal CCM operating mode and the switch current falls to 0 A, the TPS562200 begins operating in pulse skipping Eco-mode. Each switching cycle is followed by a period of energy saving sleep time. The sleep time ends when the VFB voltage falls below the Eco-mode threshold voltage. As the output current decreases, the perceived time between switching pulses increases.

7.4.3 Standby Operation

When the TPS562201 and TPS562208 are operating in either normal CCM or Eco-mode, they may be placed in standby by asserting the EN pin low.

8 Application and Implementation

NOTE

Information in the following applications sections is not part of the TI component specification, and TI does not warrant its accuracy or completeness. TI's customers are responsible for determining suitability of components for their purposes. Customers should validate and test their design implementation to confirm system functionality.

8.1 Application Information

The devices are typical step-down DC-DC converters. It typically uses to convert a higher dc voltage to a lower dc voltage with a maximum available output current of 2 A. The following design procedure can be used to select component values for the TPS562201 and TPS562208. Alternately, the WEBENCH® software may be used to generate a complete design. The WEBENCH software uses an iterative design procedure and accesses a comprehensive database of components when generating a design. This section presents a simplified discussion of the design process.

8.2 Typical Application

The application schematic in [Figure 19](#) was developed to meet the previous requirements. This circuit is available as the evaluation module (EVM). The sections provide the design procedure.

[Figure 19](#) shows the TPS562201 and TPS562208 4.5-V to 17-V Input, 1.05-V output converter schematics.

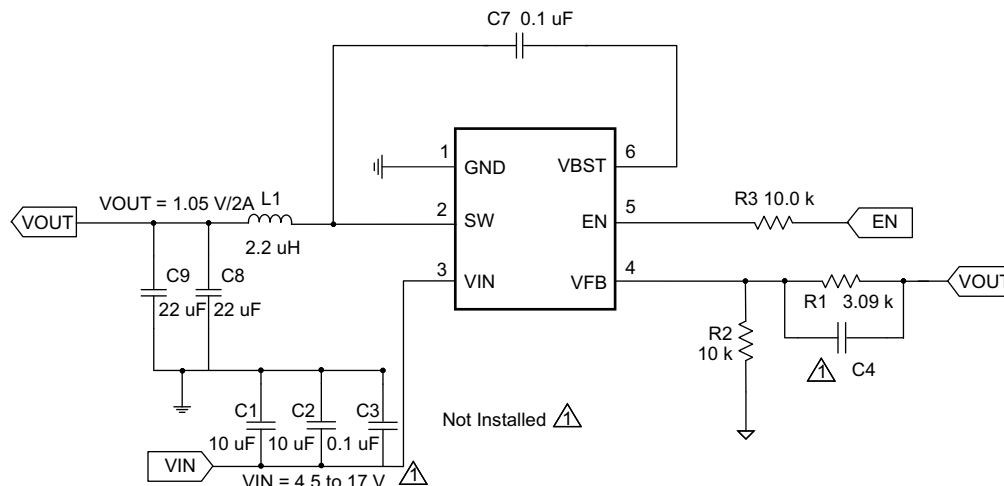


Figure 19. TPS562201 and TPS562208 1.05-V/2-A Reference Design

8.2.1 Design Requirements

[Table 1](#) shows the design parameters.

Table 1. Design Parameters

PARAMETER	EXAMPLE VALUE
Input voltage range	4.5 to 17 V
Output voltage	1.05 V
Transient response, 1.5-A load step	$\Delta V_{out} = \pm 5\%$
Input ripple voltage	400 mV
Output ripple voltage	30 mV
Output current rating	2A
Operating frequency	580 kHz

8.2.2 Detailed Design Procedure

8.2.2.1 Output Voltage Resistors Selection

The output voltage is set with a resistor divider from the output node to the VFB pin. TI recommends to use 1% tolerance or better divider resistors. Start by using [Equation 2](#) to calculate V_{OUT}.

To improve efficiency at very light loads consider using larger value resistors, too high of resistance will be more susceptible to noise and voltage errors from the VFB input current will be more noticeable.

$$V_{OUT} = 0.768 \times \left(1 + \frac{R1}{R2} \right) \quad (2)$$

8.2.2.2 Output Filter Selection

The LC filter used as the output filter has double pole at:

$$F_P = \frac{1}{2\pi\sqrt{L_{OUT} \times C_{OUT}}} \quad (3)$$

At low frequencies, the overall loop gain is set by the output set-point resistor divider network and the internal gain of the device. The low frequency phase is 180 degrees. At the output filter pole frequency, the gain rolls off at a –40 dB per decade rate and the phase drops rapidly. D-CAP2 introduces a high frequency zero that reduces the gain roll off to –20 dB per decade and increases the phase to 90 degrees one decade above the zero frequency. The inductor and capacitor for the output filter must be selected so that the double pole of Equation 3 is located below the high frequency zero but close enough that the phase boost provided by the high frequency zero provides adequate phase margin for a stable circuit. To meet this requirement use the values recommended in [Table 2](#).

Table 2. Recommended Component Values

OUTPUT VOLTAGE (V)	R1 (kΩ)	R2 (kΩ)	L1 (μH)			C8 + C9 (μF)
			MIN	TYP	MAX	
1	3.09	10.0	2.2	2.2	4.7	20 to 68
1.05	3.74	10.0	2.2	2.2	4.7	20 to 68
1.2	5.76	10.0	2.2	2.2	4.7	20 to 68
1.5	9.53	10.0	2.2	2.2	4.7	20 to 68
1.8	13.7	10.0	2.2	2.2	4.7	20 to 68
2.5	22.6	10.0	3.3	3.3	4.7	20 to 68
3.3	33.2	10.0	3.3	3.3	4.7	20 to 68
5	54.9	10.0	3.3	4.7	4.7	20 to 68
6.5	75	10.0	3.3	4.7	4.7	20 to 68

The inductor peak-to-peak ripple current, peak current and RMS current are calculated using [Equation 4](#), [Equation 5](#), and [Equation 6](#). The inductor saturation current rating must be greater than the calculated peak current and the RMS or heating current rating must be greater than the calculated RMS current.

Use 580 kHz for f_{SW}. Make sure the chosen inductor is rated for the peak current of [Equation 5](#) and the RMS current of [Equation 6](#).

$$I_{P-P} = \frac{V_{OUT}}{V_{IN(MAX)}} \times \frac{V_{IN(MAX)} - V_{OUT}}{L_O \times f_{SW}} \quad (4)$$

$$I_{PEAK} = I_O + \frac{I_{P-P}}{2} \quad (5)$$

$$I_{LO(RMS)} = \sqrt{I_O^2 + \frac{1}{12} I_{P-P}^2} \quad (6)$$

For this design example, the calculated peak current is 3.5 A and the calculated RMS current is 3.01 A. The inductor used is a WE 744311330 with a peak current rating of 11 A and an RMS current rating of 6.5 A.

The capacitor value and ESR determines the amount of output voltage ripple. The TPS562201 and TPS562208 are intended for use with ceramic or other low-ESR capacitors. Recommended values range from 20 μF to 68 μF . Use Equation 7 to determine the required RMS current rating for the output capacitor.

$$I_{\text{CO(RMS)}} = \frac{V_{\text{OUT}} \times (V_{\text{IN}} - V_{\text{OUT}})}{\sqrt{12} \times V_{\text{IN}} \times L_{\text{O}} \times f_{\text{SW}}} \quad (7)$$

For this design two TDK C3216X5R0J226M 22- μF output capacitors are used. The typical ESR is 2 m Ω each. The calculated RMS current is 0.286 A and each output capacitor is rated for 4 A.

8.2.2.3 Input Capacitor Selection

The TPS562201 and TPS562208 require an input decoupling capacitor and a bulk capacitor is needed depending on the application. TI recommends a ceramic capacitor over 10 μF for the decoupling capacitor. An additional 0.1- μF capacitor (C3) from pin 3 to ground is optional to provide additional high frequency filtering. The capacitor voltage rating needs to be greater than the maximum input voltage.

8.2.2.4 Bootstrap Capacitor Selection

A 0.1- μF ceramic capacitor must be connected between the VBST to SW pin for proper operation. TI recommends to use a ceramic capacitor.

8.2.3 Application Curves

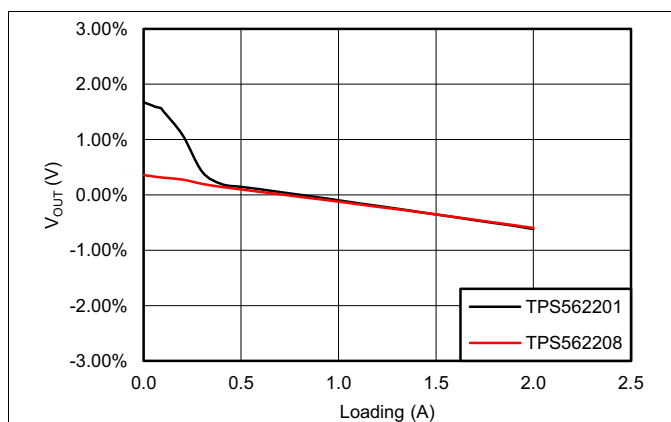


Figure 20. Load Regulation, $V_{\text{IN}} = 5 \text{ V}$

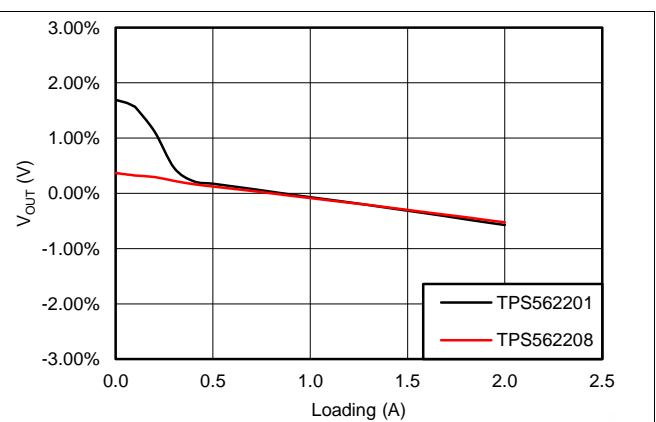
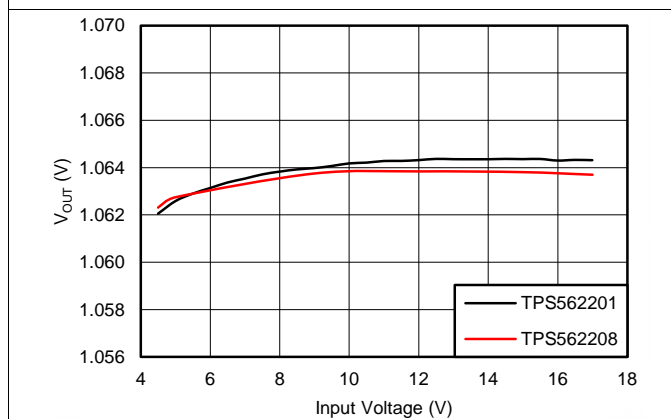


Figure 21. Load Regulation $V_{\text{IN}} = 12 \text{ V}$



TPS563201: $I_{\text{out}} = 1 \text{ A}$
 TPS563208: $I_{\text{out}} = 10 \text{ mA}$

Figure 22. Line Regulation

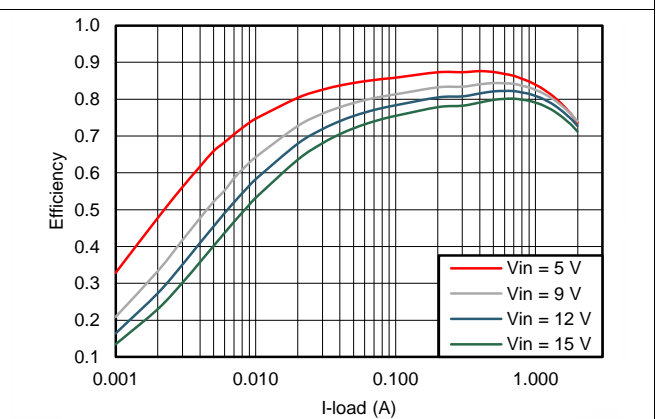


Figure 23. TPS563201 Efficiency, $V_{\text{OUT}} = 1.05 \text{ V}$

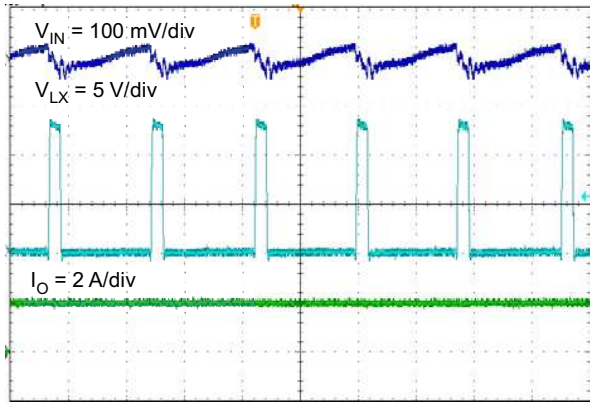


Figure 24. TPS562201 Input Voltage Ripple

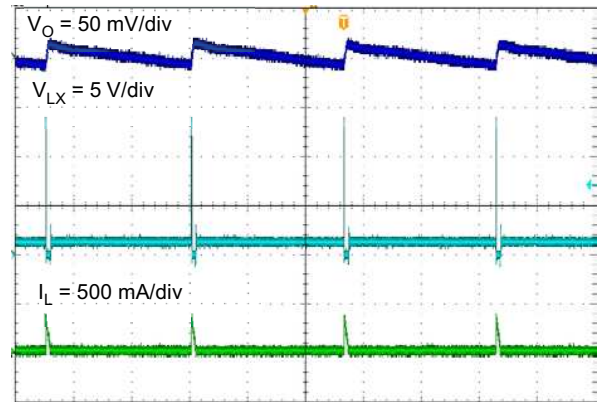


Figure 25. TPS562201 Output Voltage Ripple, $I_{OUT} = 10 \text{ mA}$

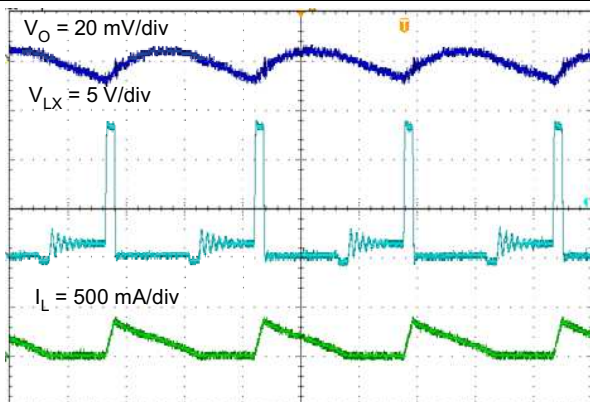


Figure 26. TPS562201 Output Voltage Ripple, $I_{OUT} = 0.25 \text{ A}$

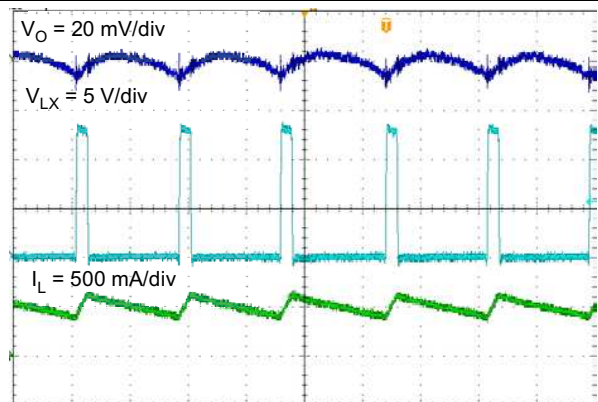


Figure 27. TPS562201 Output Voltage Ripple, $I_{OUT} = 2 \text{ A}$

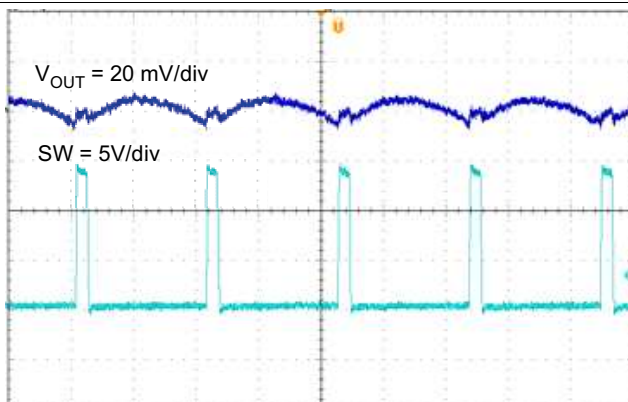


Figure 28. TPS562208 Output Voltage Ripple, $I_{OUT} = 0 \text{ A}$

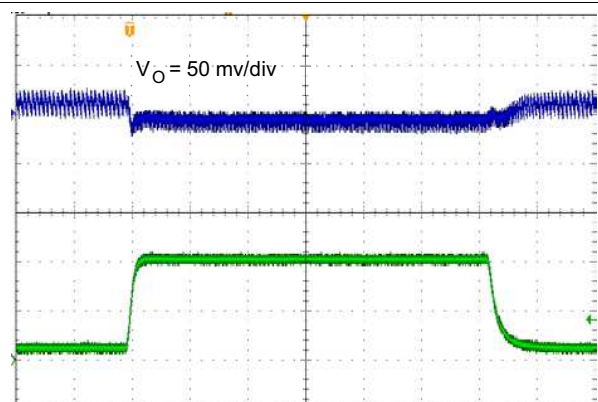


Figure 29. TPS562201 Transient Response, 0.1 to 1.5 A

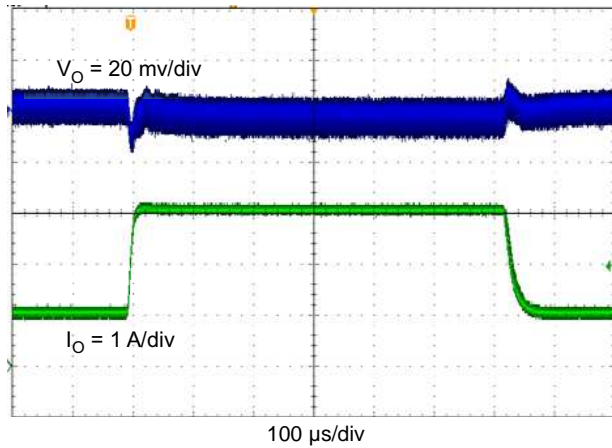


Figure 30. TPS562201 Transient Response, 0.75 to 2.25 A

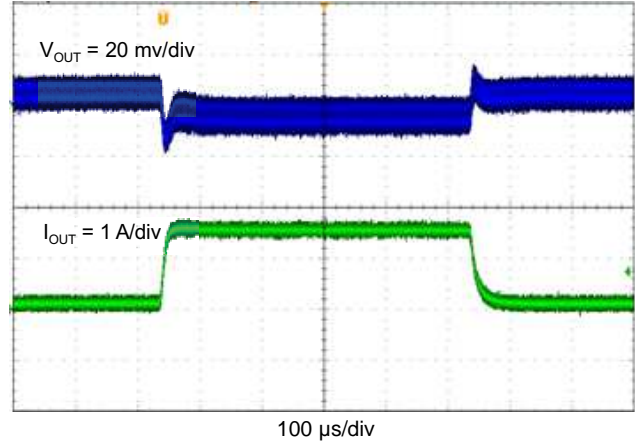


Figure 31. TPS562208 Transient Response 0.1 to 2 A

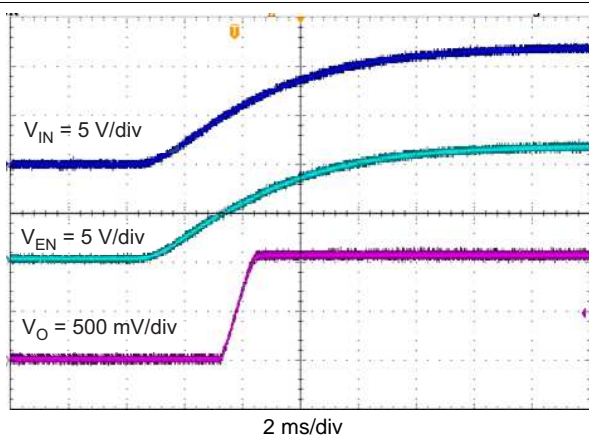


Figure 32. TPS562201 Start-Up Relative to V_I

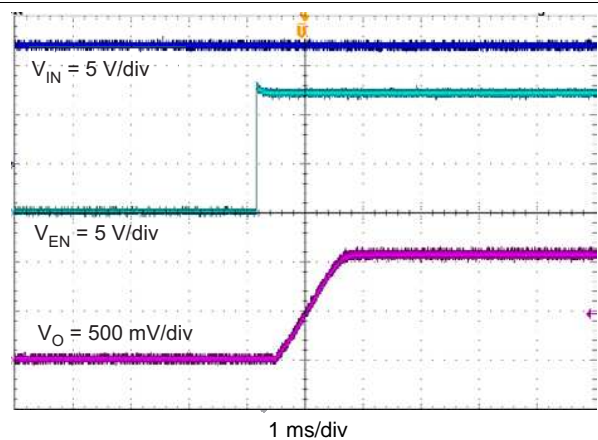


Figure 33. TPS562201 Start-Up Relative to EN

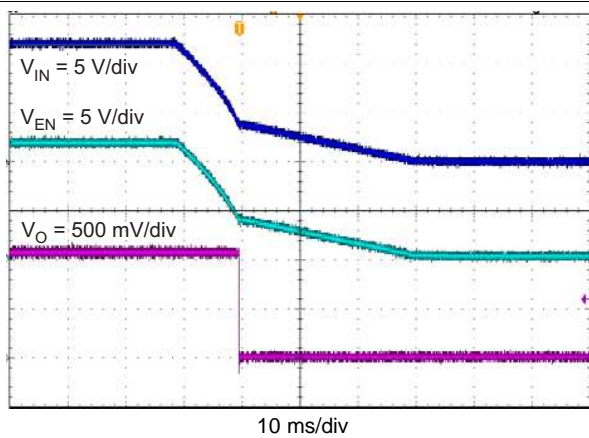


Figure 34. TPS562201 Shutdown Relative to V_I

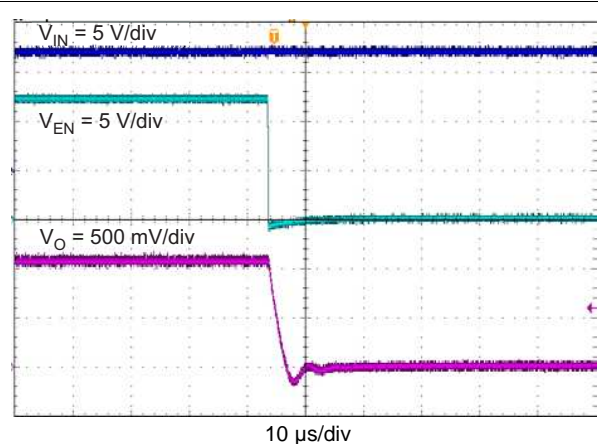


Figure 35. TPS562201 Shutdown Relative to EN

9 Power Supply Recommendations

The TPS562201 and TPS562208 are designed to operate from input supply voltage in the range of 4.5 V to 17 V. Buck converters require the input voltage to be higher than the output voltage for proper operation. The maximum recommended operating duty cycle is 75%. Using that criteria, the minimum recommended input voltage is $V_O / 0.75$.

10 Layout

10.1 Layout Guidelines

1. VIN and GND traces should be as wide as possible to reduce trace impedance. The wide areas are also of advantage from the view point of heat dissipation.
2. The input capacitor and output capacitor should be placed as close to the device as possible to minimize trace impedance.
3. Provide sufficient vias for the input capacitor and output capacitor.
4. Keep the SW trace as physically short and wide as practical to minimize radiated emissions.
5. Do not allow switching current to flow under the device.
6. A separate VOUT path should be connected to the upper feedback resistor.
7. Make a Kelvin connection to the GND pin for the feedback path.
8. Voltage feedback loop should be placed away from the high-voltage switching trace, and preferably has ground shield.
9. The trace of the VFB node should be as small as possible to avoid noise coupling.
10. The GND trace between the output capacitor and the GND pin should be as wide as possible to minimize its trace impedance.

10.2 Layout Example

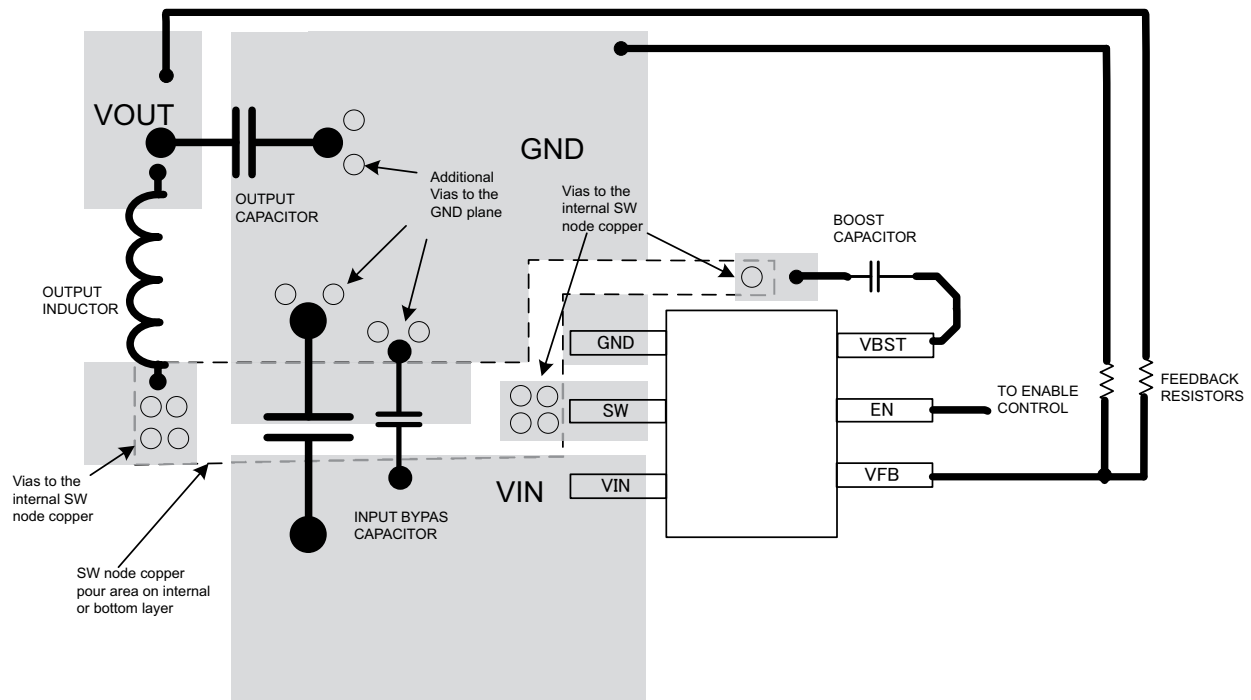


Figure 36. TPS562201 and TPS562208 Layout

11 器件和文档支持

11.1 相关链接

下面的表格列出了快速访问链接。范围包括技术文档、支持和社区资源、工具和软件，以及样片或购买的快速访问。

表 3. 相关链接

器件	产品文件夹	样片与购买	技术文档	工具与软件	支持与社区
TPS562201	请单击此处	请单击此处	请单击此处	请单击此处	请单击此处
TPS562208	请单击此处	请单击此处	请单击此处	请单击此处	请单击此处

11.2 社区资源

The following links connect to TI community resources. Linked contents are provided "AS IS" by the respective contributors. They do not constitute TI specifications and do not necessarily reflect TI's views; see TI's [Terms of Use](#).

TI E2E™ Online Community *TI's Engineer-to-Engineer (E2E) Community*. Created to foster collaboration among engineers. At e2e.ti.com, you can ask questions, share knowledge, explore ideas and help solve problems with fellow engineers.

Design Support *TI's Design Support* Quickly find helpful E2E forums along with design support tools and contact information for technical support.

11.3 商标

D-CAP2, Eco-mode, E2E are trademarks of Texas Instruments.
 WEBENCH is a registered trademark of Texas Instruments.
 Blu-Ray is a trademark of Blu-ray Disc Association.
 All other trademarks are the property of their respective owners.

11.4 静电放电警告



这些装置包含有限的内置 ESD 保护。存储或装卸时，应将导线一起截短或将装置放置于导电泡棉中，以防止 MOS 门极遭受静电损伤。

11.5 Glossary

[SLYZ022](#) — *TI Glossary*.

This glossary lists and explains terms, acronyms, and definitions.

12 机械、封装和可订购信息

以下页中包括机械、封装和可订购信息。这些信息是针对指定器件可提供的最新数据。这些数据会在无通知且不对本文档进行修订的情况下发生改变。欲获得该数据表的浏览器版本，请查阅左侧的导航栏。

重要声明

德州仪器(TI)及其下属子公司有权根据 JESD46 最新标准,对所提供的产品和服务进行更正、修改、增强、改进或其它更改,并有权根据 JESD48 最新标准中止提供任何产品和服务。客户在下订单前应获取最新的相关信息,并验证这些信息是否完整且是最新的。所有产品的销售都遵循在订单确认时所提供的TI 销售条款与条件。

TI 保证其所销售的组件的性能符合产品销售时 TI 半导体产品销售条件与条款的适用规范。仅在 TI 保证的范围内,且 TI 认为有必要时才会使用测试或其它质量控制技术。除非适用法律做出了硬性规定,否则没有必要对每种组件的所有参数进行测试。

TI 对应用帮助或客户产品设计不承担任何义务。客户应对其使用 TI 组件的产品和应用自行负责。为尽量减小与客户产品和应用相关的风险,客户应提供充分的设计与操作安全措施。

TI 不对任何 TI 专利权、版权、屏蔽作品权或其它与使用了 TI 组件或服务的组合设备、机器或流程相关的 TI 知识产权中授予的直接或隐含权限作出任何保证或解释。TI 所发布的与第三方产品或服务有关的信息,不能构成从 TI 获得使用这些产品或服务的许可、授权、或认可。使用此类信息可能需要获得第三方的专利权或其它知识产权方面的许可,或是 TI 的专利权或其它知识产权方面的许可。

对于 TI 的产品手册或数据表中 TI 信息的重要部分,仅在没有对内容进行任何篡改且带有相关授权、条件、限制和声明的情况下才允许进行复制。TI 对此类篡改过的文件不承担任何责任或义务。复制第三方的信息可能需要服从额外的限制条件。

在转售 TI 组件或服务时,如果对该组件或服务参数的陈述与 TI 标明的参数相比存在差异或虚假成分,则会失去相关 TI 组件或服务的所有明示或暗示授权,且这是不正当的、欺诈性商业行为。TI 对任何此类虚假陈述均不承担任何责任或义务。

客户认可并同意,尽管任何应用相关信息或支持仍可能由 TI 提供,但他们将独立负责满足与其产品及其在应用中使用的 TI 产品相关的所有法律、法规和安全相关要求。客户声明并同意,他们具备制定与实施安全措施所需的全部专业技术和知识,可预见故障的危险后果、监测故障及其后果、降低有可能造成人身伤害的故障的发生机率并采取适当的补救措施。客户将全额赔偿因在此类安全关键应用中使用任何 TI 组件而对 TI 及其代理造成的任何损失。

在某些场合中,为了推进安全相关应用有可能对 TI 组件进行特别的促销。TI 的目标是利用此类组件帮助客户设计和创立其特有的可满足适用的功能安全性标准和要求的终端产品解决方案。尽管如此,此类组件仍然服从这些条款。

TI 组件未获得用于 FDA Class III (或类似的生命攸关医疗设备)的授权许可,除非各方授权官员已经达成了专门管控此类使用的特别协议。

只有那些 TI 特别注明属于军用等级或“增强型塑料”的 TI 组件才是设计或专门用于军事/航空应用或环境的。购买者认可并同意,对并非指定面向军事或航空航天用途的 TI 组件进行军事或航空航天方面的应用,其风险由客户单独承担,并且由客户独立负责满足与此类使用相关的所有法律和法规要求。

TI 已明确指定符合 ISO/TS16949 要求的产品,这些产品主要用于汽车。在任何情况下,因使用非指定产品而无法达到 ISO/TS16949 要求, TI 不承担任何责任。

	产品		应用
数字音频	www.ti.com.cn/audio	通信与电信	www.ti.com.cn/telecom
放大器和线性器件	www.ti.com.cn/amplifiers	计算机及周边	www.ti.com.cn/computer
数据转换器	www.ti.com.cn/dataconverters	消费电子	www.ti.com.cn/consumer-apps
DLP® 产品	www.dlp.com	能源	www.ti.com.cn/energy
DSP - 数字信号处理器	www.ti.com.cn/dsp	工业应用	www.ti.com.cn/industrial
时钟和计时器	www.ti.com.cn/clockandtimers	医疗电子	www.ti.com.cn/medical
接口	www.ti.com.cn/interface	安防应用	www.ti.com.cn/security
逻辑	www.ti.com.cn/logic	汽车电子	www.ti.com.cn/automotive
电源管理	www.ti.com.cn/power	视频和影像	www.ti.com.cn/video
微控制器 (MCU)	www.ti.com.cn/microcontrollers		
RFID 系统	www.ti.com.cn/rfidsys		
OMAP应用处理器	www.ti.com/omap		
无线连通性	www.ti.com.cn/wirelessconnectivity	德州仪器在线技术支持社区	www.deyisupport.com

邮寄地址: 上海市浦东新区世纪大道1568号, 中建大厦32楼邮政编码: 200122
Copyright © 2016, 德州仪器半导体技术(上海)有限公司

PACKAGING INFORMATION

Orderable Device	Status (1)	Package Type	Package Drawing	Pins	Package Qty	Eco Plan (2)	Lead/Ball Finish (6)	MSL Peak Temp (3)	Op Temp (°C)	Device Marking (4/5)	Samples
TPS562201DDCR	ACTIVE	SOT	DDC	6	3000	Green (RoHS & no Sb/Br)	CU SN Call TI	Level-1-260C-UNLIM	-40 to 125	2201	Samples
TPS562201DDCT	ACTIVE	SOT	DDC	6	250	Green (RoHS & no Sb/Br)	CU SN	Level-1-260C-UNLIM	-40 to 125	2201	Samples
TPS562208DDCR	ACTIVE	SOT	DDC	6	3000	Green (RoHS & no Sb/Br)	CU SN	Level-1-260C-UNLIM	-40 to 125	2208	Samples
TPS562208DDCT	ACTIVE	SOT	DDC	6	250	Green (RoHS & no Sb/Br)	CU SN	Level-1-260C-UNLIM	-40 to 125	2208	Samples

(1) The marketing status values are defined as follows:

ACTIVE: Product device recommended for new designs.

LIFEBUY: TI has announced that the device will be discontinued, and a lifetime-buy period is in effect.

NRND: Not recommended for new designs. Device is in production to support existing customers, but TI does not recommend using this part in a new design.

PREVIEW: Device has been announced but is not in production. Samples may or may not be available.

OBSELETE: TI has discontinued the production of the device.

(2) Eco Plan - The planned eco-friendly classification: Pb-Free (RoHS), Pb-Free (RoHS Exempt), or Green (RoHS & no Sb/Br) - please check <http://www.ti.com/productcontent> for the latest availability information and additional product content details.

TBD: The Pb-Free/Green conversion plan has not been defined.

Pb-Free (RoHS): TI's terms "Lead-Free" or "Pb-Free" mean semiconductor products that are compatible with the current RoHS requirements for all 6 substances, including the requirement that lead not exceed 0.1% by weight in homogeneous materials. Where designed to be soldered at high temperatures, TI Pb-Free products are suitable for use in specified lead-free processes.

Pb-Free (RoHS Exempt): This component has a RoHS exemption for either 1) lead-based flip-chip solder bumps used between the die and package, or 2) lead-based die adhesive used between the die and leadframe. The component is otherwise considered Pb-Free (RoHS compatible) as defined above.

Green (RoHS & no Sb/Br): TI defines "Green" to mean Pb-Free (RoHS compatible), and free of Bromine (Br) and Antimony (Sb) based flame retardants (Br or Sb do not exceed 0.1% by weight in homogeneous material)

(3) MSL, Peak Temp. - The Moisture Sensitivity Level rating according to the JEDEC industry standard classifications, and peak solder temperature.

(4) There may be additional marking, which relates to the logo, the lot trace code information, or the environmental category on the device.

(5) Multiple Device Markings will be inside parentheses. Only one Device Marking contained in parentheses and separated by a "~" will appear on a device. If a line is indented then it is a continuation of the previous line and the two combined represent the entire Device Marking for that device.

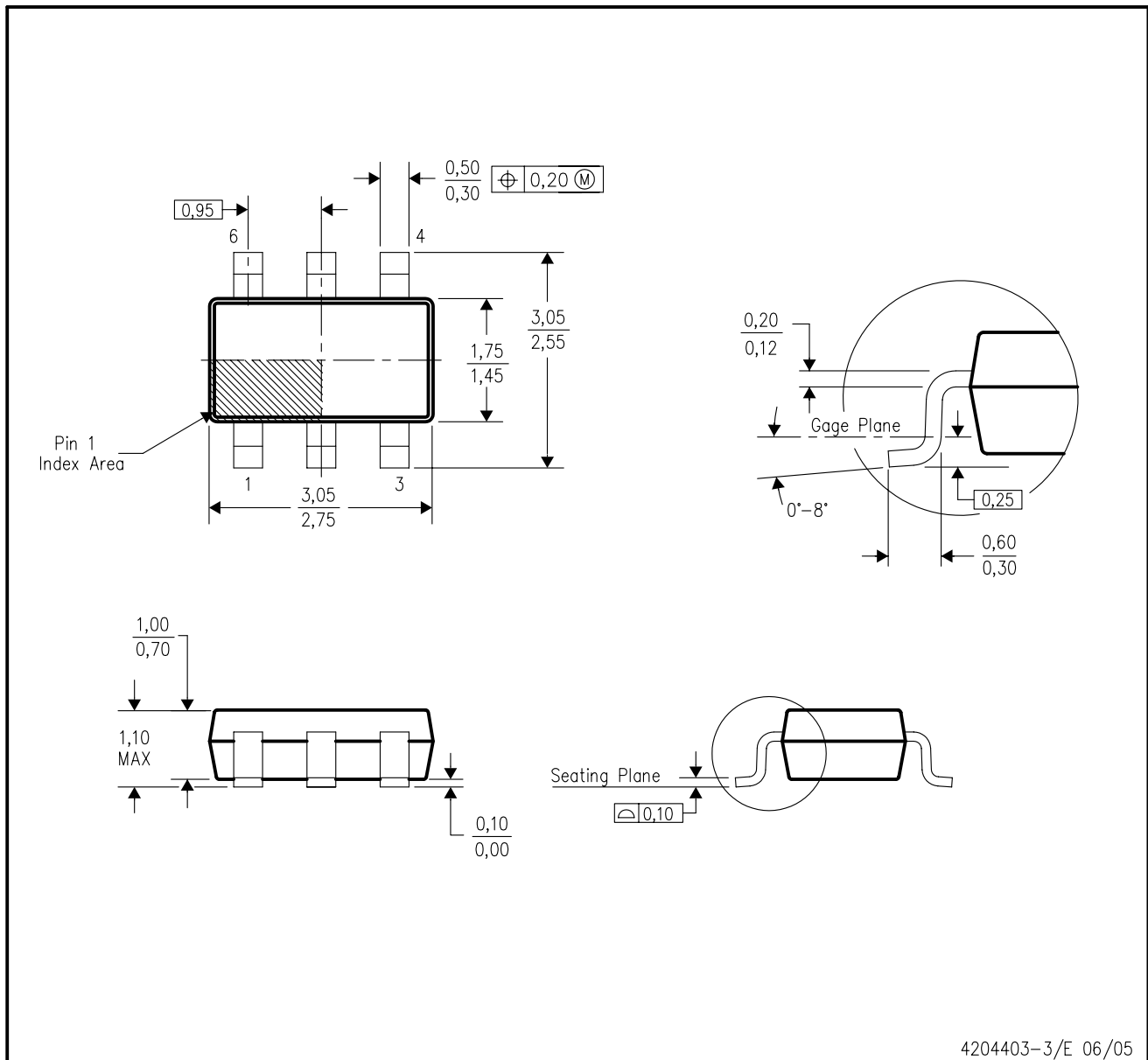
(6) Lead/Ball Finish - Orderable Devices may have multiple material finish options. Finish options are separated by a vertical ruled line. Lead/Ball Finish values may wrap to two lines if the finish value exceeds the maximum column width.

Important Information and Disclaimer: The information provided on this page represents TI's knowledge and belief as of the date that it is provided. TI bases its knowledge and belief on information provided by third parties, and makes no representation or warranty as to the accuracy of such information. Efforts are underway to better integrate information from third parties. TI has taken and continues to take reasonable steps to provide representative and accurate information but may not have conducted destructive testing or chemical analysis on incoming materials and chemicals. TI and TI suppliers consider certain information to be proprietary, and thus CAS numbers and other limited information may not be available for release.

In no event shall TI's liability arising out of such information exceed the total purchase price of the TI part(s) at issue in this document sold by TI to Customer on an annual basis.

DDC (R-PDSO-G6)

PLASTIC SMALL-OUTLINE



- NOTES:
- All linear dimensions are in millimeters.
 - This drawing is subject to change without notice.
 - Body dimensions do not include mold flash or protrusion.
 - Falls within JEDEC MO-193 variation AA (6 pin).

重要声明

德州仪器(TI) 及其下属子公司有权根据 JESD46 最新标准, 对所提供的产品和服务进行更正、修改、增强、改进或其它更改, 并有权根据 JESD48 最新标准中止提供任何产品和服务。客户在下订单前应获取最新的相关信息, 并验证这些信息是否完整且是最新的。所有产品的销售都遵循在订单确认时所提供的TI 销售条款与条件。

TI 保证其所销售的组件的性能符合产品销售时 TI 半导体产品销售条件与条款的适用规范。仅在 TI 保证的范围内, 且 TI 认为有必要时才会使用测试或其它质量控制技术。除非适用法律做出了硬性规定, 否则没有必要对每种组件的所有参数进行测试。

TI 对应用帮助或客户产品设计不承担任何义务。客户应对其使用 TI 组件的产品和应用自行负责。为尽量减小与客户产品和应用相关的风险, 客户应提供充分的设计与操作安全措施。

TI 不对任何 TI 专利权、版权、屏蔽作品权或其它与使用了 TI 组件或服务的组合设备、机器或流程相关的 TI 知识产权中授予的直接或间接版权限作出任何保证或解释。TI 所发布的与第三方产品或服务有关的信息, 不能构成从 TI 获得使用这些产品或服务的许可、授权、或认可。使用此类信息可能需要获得第三方的专利权或其它知识产权方面的许可, 或是 TI 的专利权或其它知识产权方面的许可。

对于 TI 的产品手册或数据表中 TI 信息的重要部分, 仅在没有对内容进行任何篡改且带有相关授权、条件、限制和声明的情况下才允许进行复制。TI 对此类篡改过的文件不承担任何责任或义务。复制第三方的信息可能需要服从额外的限制条件。

在转售 TI 组件或服务时, 如果对该组件或服务参数的陈述与 TI 标明的参数相比存在差异或虚假成分, 则会失去相关 TI 组件或服务的所有明示或暗示授权, 且这是不正当的、欺诈性商业行为。TI 对任何此类虚假陈述均不承担任何责任或义务。

客户认可并同意, 尽管任何应用相关信息或支持仍可能由 TI 提供, 但他们将独自负责满足与其产品及其应用中使用的 TI 产品相关的所有法律、法规和安全相关要求。客户声明并同意, 他们具备制定与实施安全措施所需的全部专业技术和知识, 可预见故障的危险后果、监测故障及其后果、降低有可能造成人身伤害的故障的发生机率并采取适当的补救措施。客户将全额赔偿因在此类安全关键应用中使用任何 TI 组件而对 TI 及其代理造成的任何损失。

在某些场合中, 为了推进安全相关应用有可能对 TI 组件进行特别的促销。TI 的目标是利用此类组件帮助客户设计和创立其特有的可满足适用的功能安全性标准和要求的终端产品解决方案。尽管如此, 此类组件仍然服从这些条款。

TI 组件未获得用于 FDA Class III (或类似的生命攸关医疗设备) 的授权许可, 除非各方授权官员已经达成了专门管控此类使用的特别协议。

只有那些 TI 特别注明属于军用等级或“增强型塑料”的 TI 组件才是设计或专门用于军事/航空应用或环境的。购买者认可并同意, 对并非指定面向军事或航空航天用途的 TI 组件进行军事或航空航天方面的应用, 其风险由客户单独承担, 并且由客户独自负责满足与此类使用相关的所有法律和法规要求。

TI 已明确指定符合 ISO/TS16949 要求的产品, 这些产品主要用于汽车。在任何情况下, 因使用非指定产品而无法达到 ISO/TS16949 要求, TI 不承担任何责任。

	产品		应用
数字音频	www.ti.com.cn/audio	通信与电信	www.ti.com.cn/telecom
放大器和线性器件	www.ti.com.cn/amplifiers	计算机及周边	www.ti.com.cn/computer
数据转换器	www.ti.com.cn/dataconverters	消费电子	www.ti.com.cn/consumer-apps
DLP® 产品	www.dlp.com	能源	www.ti.com.cn/energy
DSP - 数字信号处理器	www.ti.com.cn/dsp	工业应用	www.ti.com.cn/industrial
时钟和计时器	www.ti.com.cn/clockandtimers	医疗电子	www.ti.com.cn/medical
接口	www.ti.com.cn/interface	安防应用	www.ti.com.cn/security
逻辑	www.ti.com.cn/logic	汽车电子	www.ti.com.cn/automotive
电源管理	www.ti.com.cn/power	视频和影像	www.ti.com.cn/video
微控制器 (MCU)	www.ti.com.cn/microcontrollers		
RFID 系统	www.ti.com.cn/rfidsys		
OMAP应用处理器	www.ti.com.cn/omap		
无线连通性	www.ti.com.cn/wirelessconnectivity	德州仪器在线技术支持社区	www.deyisupport.com

Mailing Address: Texas Instruments, Post Office Box 655303, Dallas, Texas 75265
Copyright © 2016, Texas Instruments Incorporated