

ESP32 Technical Reference Manual



Espressif Systems

August 31, 2016

About This Manual

ESP32 Technical Reference Manual targets application developers. The manual provides detailed and complete information on how to use the ESP32 memory and peripherals.

Release Notes

Date	Version	Release notes
2016.08	V1.0	Initial release.

Disclaimer and Copyright Notice

Information in this document, including URL references, is subject to change without notice. THIS DOCUMENT IS PROVIDED AS IS WITH NO WARRANTIES WHATSOEVER, INCLUDING ANY WARRANTY OF MERCHANTABILITY, NON-INFRINGEMENT, FITNESS FOR ANY PARTICULAR PURPOSE, OR ANY WARRANTY OTHERWISE ARISING OUT OF ANY PROPOSAL, SPECIFICATION OR SAMPLE.

All liability, including liability for infringement of any proprietary rights, relating to use of information in this document is disclaimed. No licenses express or implied, by estoppel or otherwise, to any intellectual property rights are granted herein. The Wi-Fi Alliance Member logo is a trademark of the Wi-Fi Alliance. The Bluetooth logo is a registered trademark of Bluetooth SIG.

All trade names, trademarks and registered trademarks mentioned in this document are property of their respective owners, and are hereby acknowledged.

Copyright © 2016 Espressif Inc. All rights reserved.

Contents

1	System and Memory	8
1.1	Introduction	8
1.2	Features	8
1.3	Functional Description	10
1.3.1	Address Mapping	10
1.3.2	Embedded Memory	10
1.3.2.1	Internal ROM 0	11
1.3.2.2	Internal ROM 1	11
1.3.2.3	Internal SRAM 0	12
1.3.2.4	Internal SRAM 1	12
1.3.2.5	Internal SRAM 2	13
1.3.2.6	DMA	13
1.3.2.7	RTC FAST Memory	13
1.3.2.8	RTC SLOW Memory	13
1.3.3	External Memory	13
1.3.4	Peripherals	14
1.3.4.1	Asymmetric PID Controller Peripheral	15
1.3.4.2	Non-Contiguous Peripheral Memory Ranges	15
1.3.4.3	Memory Speed	16
2	Interrupt Matrix	17
2.1	Introduction	17
2.2	Features	17
2.3	Functional Description	17
2.3.1	Peripheral Interrupt Source	17
2.3.2	CPU Interrupt	20
2.3.3	Allocate Peripheral Interrupt Sources to Peripheral Interrupt on CPU	20
2.3.4	CPU NMI Interrupt Mask	21
2.3.5	Query Current Interrupt Status of Peripheral Interrupt Source	21
3	Reset and Clock	22
3.1	System Reset	22
3.1.1	Introduction	22
3.1.2	Reset Source	22
3.2	System Clock	23
3.2.1	Introduction	23
3.2.2	Clock Source	24
3.2.3	CPU Clock	24
3.2.4	Peripheral Clock	25
3.2.4.1	APB_CLK Source	25
3.2.4.2	REF_TICK Source	26
3.2.4.3	LEDC_SCLK Source	26
3.2.4.4	APLL_SCLK Source	26
3.2.4.5	PLL_D2_CLK Source	26

3.2.4.6	Clock Source Considerations	27
3.2.5	Wi-Fi BT Clock	27
3.2.6	RTC Clock	27
4	IO_MUX and GPIO Matrix	28
4.1	Introduction	28
4.2	Peripheral Input via GPIO Matrix	29
4.2.1	Summary	29
4.2.2	Functional Description	29
4.2.3	Simple GPIO Input	30
4.3	Peripheral Output via GPIO Matrix	30
4.3.1	Summary	30
4.3.2	Functional Description	30
4.3.3	Simple GPIO Output	31
4.4	Direct I/O via IO_MUX	31
4.4.1	Summary	31
4.4.2	Functional Description	32
4.5	RTC IO_MUX for Low Power and Analog I/O	32
4.5.1	Summary	32
4.5.2	Functional Description	32
4.6	Light-sleep Mode Pin Functions	32
4.7	Pad Hold Feature	33
4.8	I/O Pad Power Supply	33
4.8.1	VDD_SDIO Power Domain	33
4.9	Peripheral Signal List	34
4.10	IO_MUX Pad List	38
4.11	RTC_MUX Pin List	39
4.12	Register Summary	40
4.13	Registers	45
5	LED_PWM	66
5.1	Introduction	66
5.2	Functional Description	66
5.2.1	Architecture	66
5.2.2	Timers	67
5.2.3	Channels	67
5.2.4	Interrupts	68
5.3	Register Summary	68
5.4	Registers	71
6	Remote Controller Peripheral	81
6.1	Introduction	81
6.2	Functional Description	81
6.2.1	RMT Architecture	81
6.2.2	RMT RAM	82
6.2.3	Clock	82
6.2.4	Transmitter	82

6.2.5	Receiver	83
6.2.6	Interrupts	83
6.3	Register Summary	84
6.4	Registers	85
7	PULSE_CNT	90
7.1	Introduction	90
7.2	Functional Description	90
7.2.1	Architecture	90
7.2.2	Counter Channel Inputs	90
7.2.3	Watchpoints	91
7.2.4	Examples	92
7.2.5	Interrupts	92
7.3	Register Summary	92
7.4	Registers	94
8	64-bit Timers	98
8.1	Introduction	98
8.2	Functional Description	98
8.2.1	16-bit Prescaler	98
8.2.2	64-bit Time-base Counter	98
8.2.3	Alarm Generation	99
8.2.4	MWDT	99
8.2.5	Interrupts	99
8.3	Register summary	99
8.4	Registers	101
9	Watchdog Timers	108
9.1	Introduction	108
9.2	Features	108
9.3	Functional Description	108
9.3.1	Clock	108
9.3.1.1	Operating Procedure	109
9.3.1.2	Write Protection	109
9.3.1.3	Flash Boot Protection	109
9.3.1.4	Registers	110
10	AES Accelerator	111
10.1	Introduction	111
10.2	Features	111
10.3	Functional Description	111
10.3.1	AES Algorithm Operations	111
10.3.2	Key, Plaintext and Ciphertext	111
10.3.3	Endianness	112
10.3.4	Encryption and Decryption Operations	114
10.3.5	Speed	114
10.4	Register summary	114

10.5 Registers	116
11 SHA Accelerator	118
11.1 Introduction	118
11.2 Features	118
11.3 Functional Description	118
11.3.1 Padding and Parsing the Message	118
11.3.2 Message Digest	118
11.3.3 Hash Operation	119
11.3.4 Speed	119
11.4 Register Summary	119
11.5 Registers	121

List of Tables

1	Address Mapping	10
2	Embedded Memory Address Mapping	11
3	Module with DMA	13
4	External Memory Address Mapping	14
5	Peripheral Address Mapping	14
6	PRO_CPU, APP_CPU interrupt configuration	18
7	CPU Interrupts	20
8	PRO_CPU and APP_CPU reset reason values	22
9	CPU_CLK Source	24
10	CPU_CLK Derivation	25
11	Peripheral Clock Usage	25
12	APB_CLK Derivation	26
13	REF_TICK Derivation	26
14	LEDC_SCLK Derivation	26
15	IO_MUX Light-sleep Pin Function Registers	32
16	GPIO Matrix Peripheral Signals	34
17	IO_MUX Pad Summary	38
18	RTC_MUX Pin Summary	39
26	Operation Mode	111
27	AES Text Endianness	112
28	AES-128 Key Endianness	113
29	AES-192 Key Endianness	113
30	AES-256 Key Endianness	113

List of Figures

1	System Structure	9
2	System Address Mapping	9
3	Interrupt Matrix Structure	17
4	System Reset	22
5	System Clock	23
6	IO_MUX, RTC IO_MUX and GPIO Matrix Overview	28
7	Peripheral Input via IO_MUX, GPIO Matrix	29
8	Output via GPIO Matrix	31
9	ESP32 I/O Pad Power Sources	33
10	LED_PWM Architecture	66
11	LED_PWM High-speed Channel Diagram	66
12	LED PWM Output Signal Diagram	67
13	Output Signal Diagram of Gradient Duty Cycle	68
14	RMT Architecture	81
15	Data Structure	82
16	PULSE_CNT Architecture	90
17	PULSE_CNT Upcounting Diagram	92
18	PULSE_CNT Downcounting Diagram	92

1. System and Memory

1.1 Introduction

The ESP32 is a dual-core system with two Harvard Architecture Xtensa LX6 CPUs. All embedded memory, external memory and peripherals are located on the data bus and/or the instruction bus of these CPUs.

With some minor exceptions (see below), the address mapping of two CPUs is symmetric, meaning they use the same addresses to access the same memory. Multiple peripherals in the system can access embedded memory via DMA.

The two CPUs are named “PRO_CPU” and “APP_CPU” (for “protocol” and “application”), however for most purposes the two CPUs are interchangeable.

1.2 Features

- Address Space
 - Symmetric address mapping
 - 4 GB (32-bit) address space for both data bus and instruction bus
 - 1296 KB embedded memory address space
 - 19704 KB external memory address space
 - 512 KB peripheral address space
 - Some embedded and external memory regions can be accessed by either data bus or instruction bus
 - 328 KB DMA address space
- Embedded Memory
 - 448 KB Internal ROM
 - 520 KB Internal SRAM
 - 8 KB RTC FAST Memory
 - 8 KB RTC SLOW Memory
- External Memory

Off-chip SPI memory can be mapped into the available address space as external memory. Parts of the embedded memory can be used as transparent cache for this external memory.

 - Supports up to 16 MB off-Chip SPI Flash.
 - Supports up to 8 MB off-Chip SPI SRAM.
- Peripherals
 - 41 peripherals
- DMA
 - 13 modules are capable of DMA operation

Figure 1 block diagram illustrates the system structure, the block diagram in Figure 2 illustrates the address map structure.

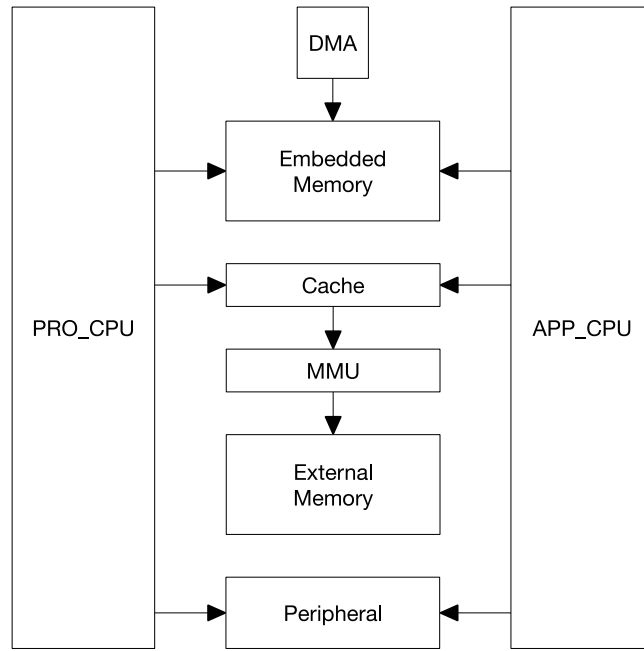

Figure 1: System Structure

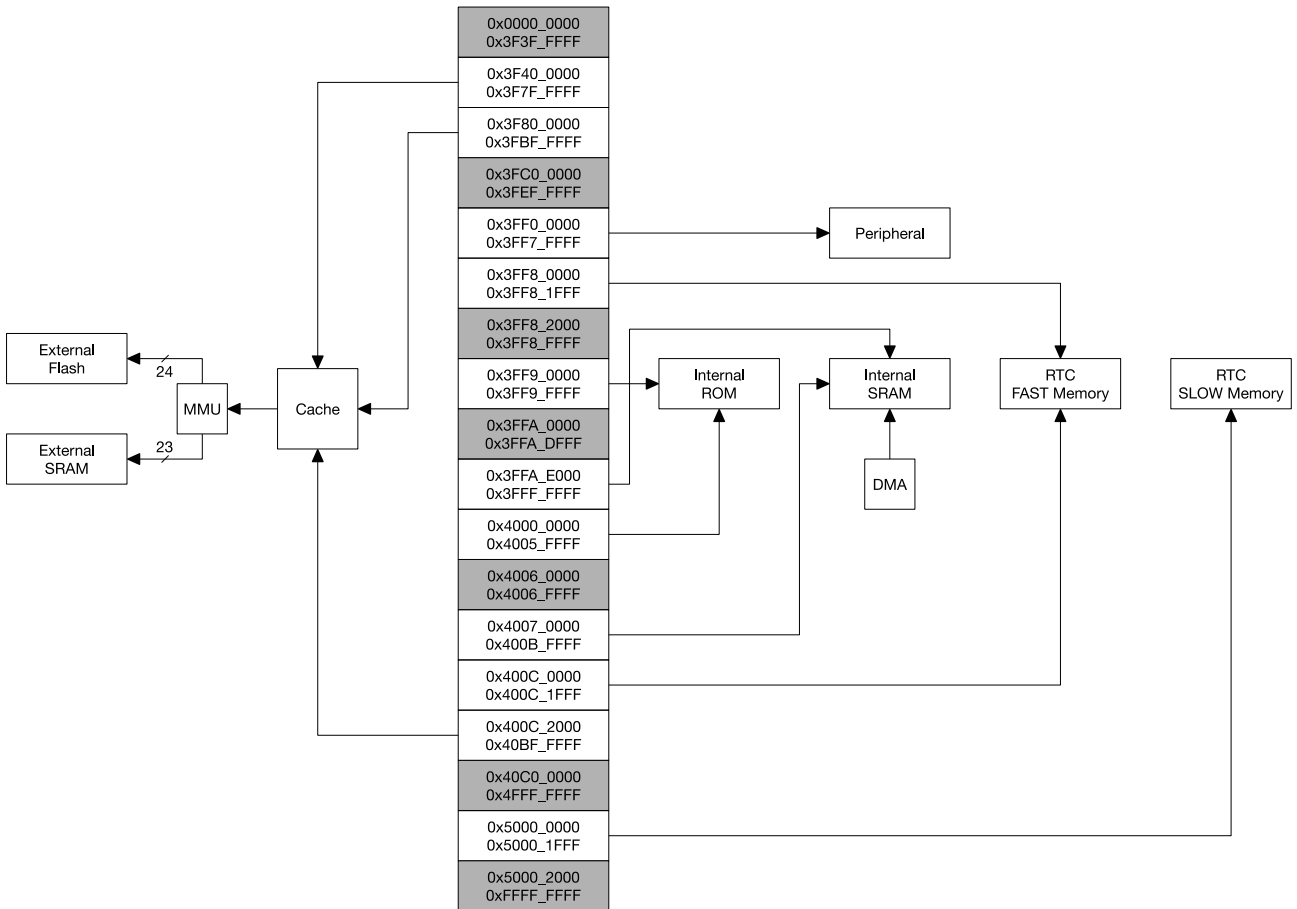

Figure 2: System Address Mapping

1.3 Functional Description

1.3.1 Address Mapping

Each of the two Harvard Architecture Xtensa LX6 CPUs has 4 GB (32-bit) address space. Address spaces are symmetric between the two CPUs.

Addresses below 0x4000_0000 are serviced using the data bus. Addresses in the range 0x4000_0000 ~ 0x4FFF_FFFF are serviced using the instruction bus. Finally, addresses over and including 0x5000_0000 are shared by the data and instruction bus.

The data bus and instruction bus are both little-endian: for example, byte addresses 0x0, 0x1, 0x2, 0x3 access the least significant, second least significant, second most significant, and most significant bytes of the 32-bit word stored at address 0x0, respectively. The CPU can access data bus addresses via aligned or non-aligned byte, half-word and word read and write operations. The CPU can read and write data through the instruction bus, but only in a **word aligned manner**; non-word-aligned access will cause a CPU exception.

Each CPU can directly access embedded memory through both the data bus and the instruction bus, external memory which is mapped into the address space (via transparent caching & MMU) and peripherals. Table 1 illustrates address ranges that can be accessed by each CPU's data bus and instruction bus.

Some embedded memories and some external memories can be accessed via the data bus or the instruction bus. In these cases, the same memory is available to either of the CPUs at two address ranges.

Table 1: Address Mapping

Bus Type	Boundary Address		Size	Target
	Low Address	High Address		
	0x0000_0000	0x3F3F_FFFF		Reserved
Data	0x3F40_0000	0x3F7F_FFFF	4 MB	External Memory
Data	0x3F80_0000	0x3FBF_FFFF	4 MB	External Memory
	0x3FC0_0000	0x3FEF_FFFF	3 MB	Reserved
Data	0x3FF0_0000	0x3FF7_FFFF	512 KB	Peripheral
Data	0x3FF8_0000	0x3FFF_FFFF	512 KB	Embedded Memory
Instruction	0x4000_0000	0x400C_1FFF	776 KB	Embedded Memory
Instruction	0x400C_2000	0x40BF_FFFF	11512 KB	External Memory
	0x40C0_0000	0x4FFF_FFFF	244 MB	Reserved
Data Instruction	0x5000_0000	0x5000_1FFF	8 KB	Embedded Memory
	0x5000_2000	0xFFFF_FFFF		Reserved

1.3.2 Embedded Memory

The Embedded Memory consists of four segments: internal ROM (448 KB), internal SRAM (520 KB), RTC FAST memory (8 KB) and RTC SLOW memory (8 KB).

The 448 KB internal ROM is divided into two parts: Internal ROM 0 (384 KB) and Internal ROM 1 (64 KB).

The 520 KB internal SRAM is divided into three parts: Internal SRAM 0 (192 KB), Internal SRAM 1 (128 KB), and Internal SRAM 2 (200 KB).

RTC FAST Memory and RTC SLOW Memory are both implemented as SRAM.

Table 2 lists all embedded memories and their address ranges on the data and instruction buses.

Table 2: Embedded Memory Address Mapping

Bus Type	Boundary Address		Size	Target	Comment
	Low Address	High Address			
Data	0x3FF8_0000	0x3FF8_1FFF	8 KB	RTC FAST Memory	PRO_CPU Only
	0x3FF8_2000	0x3FF8_FFFF	56 KB	Reserved	-
Data	0x3FF9_0000	0x3FF9_FFFF	64 KB	Internal ROM 1	-
	0x3FFA_0000	0x3FFA_DFFF	56 KB	Reserved	-
Data	0x3FFA_E000	0x3FFD_FFFF	200 KB	Internal SRAM 2	DMA
Data	0x3FFE_0000	0x3FFF_FFFF	128 KB	Internal SRAM 1	DMA
Bus Type	Boundary Address		Size	Target	Comment
	Low Address	High Address			
Instruction	0x4000_0000	0x4000_7FFF	32 KB	Internal ROM 0	Remap
Instruction	0x4000_8000	0x4005_FFFF	352 KB	Internal ROM 0	-
	0x4006_0000	0x4006_FFFF	64 KB	Reserved	-
Instruction	0x4007_0000	0x4007_FFFF	64 KB	Internal SRAM 0	Cache
Instruction	0x4008_0000	0x4009_FFFF	128 KB	Internal SRAM 0	-
Instruction	0x400A_0000	0x400A_FFFF	64 KB	Internal SRAM 1	-
Instruction	0x400B_0000	0x400B_7FFF	32 KB	Internal SRAM 1	Remap
Instruction	0x400B_8000	0x400B_FFFF	32 KB	Internal SRAM 1	-
Instruction	0x400C_0000	0x400C_1FFF	8 KB	RTC FAST Memory	PRO_CPU Only
Bus Type	Boundary Address		Size	Target	Comment
	Low Address	High Address			
Data Instruction	0x5000_0000	0x5000_1FFF	8 KB	RTC SLOW Memory	-

1.3.2.1 Internal ROM 0

The capacity of Internal ROM 0 is 384 KB, It is accessible by both CPUs through the address range 0x4000_0000 ~ 0x4005_FFFF, which is on the instruction bus.

The address range of the first 32 KB of the ROM 0 (0x4000_0000 ~ 0x4000_7FFF) can be re-mapped to access a part of Internal SRAM 1 that normally resides in the memory range 0x400B_0000 ~ 0x400B_7FFF instead. While remapping, such 32 KB SRAM can not be accessed by address range 0x400B_0000 ~ 0x400B_7FFF any more, but it can still be accessible through the data bus (0x3FFE_8000 ~ 0x3FFE_FFFF). This can be done on a per-CPU basis: setting bit 0 of register DPORT_PRO_BOOT_REMAP_CTRL_REG or DPORT_APP_BOOT_REMAP_CTRL_REG will remap SRAM for the PRO_CPU and APP_CPU, respectively.

1.3.2.2 Internal ROM 1

The capacity of Internal ROM 1 is 64 KB. It can be read by either CPU at address range 0x3FF9_0000 ~ 0x3FF9_FFFF of the data bus.

1.3.2.3 Internal SRAM 0

The capacity of Internal SRAM 0 is 192 KB. Hardware can be configured to use the first 64KB to cache external memory access. When not used as cache, the first 64KB can be read and written by either CPU at addresses 0x4007_0000 ~ 0x4007_7FFF of the instruction bus. The remaining 128 KB can always be read and written by either CPU at addresses 0x4007_8000 ~ 0x4007_FFFF of instruction bus.

1.3.2.4 Internal SRAM 1

The capacity of Internal SRAM 1 is 128 KB. Either CPU can read and write this memory at addresses 0x3FFE_0000 ~ 0x3FFF_FFFF of the data bus, and also at addresses 0x400A_0000 ~ 0x400B_FFFF of the instruction bus.

The address range accessed via the instruction bus is in reverse order (word-wise) compared to access via the data bus. That is to say, address

0x3FFE_0000 and 0x400B_FFFC access the same word

0x3FFE_0004 and 0x400B_FFF8 access the same word

0x3FFE_0008 and 0x400B_FFF4 access the same word

.....

0x3FFF_FFF4 and 0x400A_0008 access the same word

0x3FFF_FFF8 and 0x400A_0004 access the same word

0x3FFF_FFFC and 0x400A_0000 access the same word

The data bus and instruction bus of the CPU are still both little endian, so the byte order of individual words is not reversed between address spaces. For example, address

0x3FFE_0000 accesses the least significant byte in the word accessed by 0x400B_FFFC.

0x3FFE_0001 accesses the second least significant byte in the word accessed by 0x400B_FFFC.

0x3FFE_0002 accesses the second most significant byte in the word accessed by 0x400B_FFFC.

0x3FFE_0003 accesses the most significant byte in the word accessed by 0x400B_FFFC.

0x3FFE_0004 accesses the least significant byte in the word accessed by 0x400B_FFF8.

0x3FFE_0005 accesses the second least significant byte in the word accessed by 0x400B_FFF8.

0x3FFE_0006 accesses the second most significant byte in the word accessed by 0x400B_FFF8.

0x3FFE_0007 accesses the most significant byte in the word accessed by 0x400B_FFF8.

.....

0x3FFF_FFF8 accesses the least significant byte in the word accessed by 0x400A_0004.

0x3FFF_FFF9 accesses the second least significant byte in the word accessed by 0x400A_0004.

0x3FFF_FFFA accesses the second most significant byte in the word accessed by 0x400A_0004.

0x3FFF_FFFB accesses the most significant byte in the word accessed by 0x400A_0004.

0x3FFF_FFFC accesses the least significant byte in the word accessed by 0x400A_0000.

0x3FFF_FFFD accesses the second most significant byte in the word accessed by 0x400A_0000.

0x3FFF_FFFE accesses the second most significant byte in the word accessed by 0x400A_0000.

0x3FFF_FFFF accesses the most significant byte in the word accessed by 0x400A_0000.

Part of this memory can be remapped to the ROM 0 address space. See [Internal Rom 0](#) for more information.

1.3.2.5 Internal SRAM 2

The capacity of Internal SRAM 2 is 200 KB. It can be read and written by either CPU at addresses 0x3FFA_E000 ~ 0x3FFD_FFFF on the data bus.

1.3.2.6 DMA

DMA uses the same addressing as the CPU data bus to read and write Internal SRAM 1 and Internal SRAM 2. This means DMA uses address range 0x3FFE_0000 ~ 0x3FFF_FFFF to read and write Internal SRAM 1 and address range 0x3FFA_E000 ~ 0x3FFD_FFFF to read and write Internal SRAM 2.

In the ESP32, 13 peripherals are equipped with DMA. Table 3 lists these peripherals.

Table 3: Module with DMA

UART0	UART1	UART2
SPI1	SPI2	SPI3
I2S0	I2S1	
SDIO Slave	SDMMC	
EMAC		
BT	WIFI	

1.3.2.7 RTC FAST Memory

RTC FAST Memory is 8 KB of SRAM. It can be read and written by PRO_CPU only at address range 0x3FF8_0000 ~ 0x3FF8_1FFF on the data bus or address range 0x400C_0000 ~ 0x400C_1FFF on the instruction bus. Unlike most other memory regions, RTC FAST memory cannot be accessed by the APP_CPU.

The two address ranges of PRO_CPU access RTC FAST Memory in the same order, so for example, address 0x3FF8_0000 and 0x400C_0000 access the same word. **On the APP_CPU, these address ranges do not provide access to RTC FAST Memory or any other memory location.**

1.3.2.8 RTC SLOW Memory

RTC SLOW Memory is 8 KB of SRAM which can be read from and written by either CPU at address range 0x5000_0000 ~ 0x5000_1FFF. This address range is shared by both the data bus and the instruction bus.

1.3.3 External Memory

The ESP32 can access external SPI flash and SPI SRAM as external memory. Table 4 provides a list of external memories that can be accessed by either CPU at a range of addresses on the data and instruction buses. When a CPU accesses external memory through the Cache and MMU, the cache will map the CPU's address to an external physical memory address (in the external memory's address space), according to the MMU settings. Due to this address mapping, the ESP32 can address up to 16 MB External Flash and 8 MB External SRAM.

Table 4: External Memory Address Mapping

Bus Type	Boundary Address		Size	Target	Comment
	Low Address	High Address			
Data	0x3F40_0000	0x3F7F_FFFF	4 MB	External Flash	Read
Data	0x3F80_0000	0x3FBF_FFFF	4 MB	External SRAM	Read and Write
Bus Type	Boundary Address		Size	Target	Comment
	Low Address	High Address			
Instruction	0x400C_2000	0x40BF_FFFF	11512 KB	External Flash	Read

1.3.4 Peripherals

The ESP32 has 41 peripherals. Table 5 specifically describes the peripherals their respective address ranges. Almost all peripheral modules can be accessed by either CPU at the same address, the only exception being the PID Controller.

Table 5: Peripheral Address Mapping

Bus Type	Boundary Address		Size	Target	Comment
	Low Address	High Address			
Data	0x3FF0_0000	0x3FF0_0FFF	4 KB	DPort Register	
Data	0x3FF0_1000	0x3FF0_1FFF	4 KB	AES Accelerator	
Data	0x3FF0_2000	0x3FF0_2FFF	4 KB	RSA Accelerator	
Data	0x3FF0_3000	0x3FF0_3FFF	4 KB	SHA Accelerator	
Data	0x3FF0_4000	0x3FF0_4FFF	4 KB	Secure Boot	
	0x3FF0_5000	0x3FF0_FFFF	44 KB	Reserved	
Data	0x3FF1_0000	0x3FF1_3FFF	16 KB	Cache MMU Table	
	0x3FF1_4000	0x3FF1_EFFF	44 KB	Reserved	
Data	0x3FF1_F000	0x3FF1_FFFF	4 KB	PID Controller	Per-CPU peripheral
	0x3FF2_0000	0x3FF3_FFFF	128 KB	Reserved	
Data	0x3FF4_0000	0x3FF4_0FFF	4 KB	UART0	
	0x3FF4_1000	0x3FF4_1FFF	4 KB	Reserved	
Data	0x3FF4_2000	0x3FF4_2FFF	4 KB	SPI1	
Data	0x3FF4_3000	0x3FF4_3FFF	4 KB	SPI0	
Data	0x3FF4_4000	0x3FF4_4FFF	4 KB	GPIO	
	0x3FF4_5000	0x3FF4_7FFF	12 KB	Reserved	
Data	0x3FF4_8000	0x3FF4_8FFF	4 KB	RTC	
Data	0x3FF4_9000	0x3FF4_9FFF	4 KB	IO MUX	
	0x3FF4_A000	0x3FF4_AFFF	4 KB	Reserved	
Data	0x3FF4_B000	0x3FF4_BFFF	4 KB	SDIO Slave	One of three parts
Data	0x3FF4_C000	0x3FF4_CFFF	4 KB	UDMA1	
	0x3FF4_D000	0x3FF4_EFFF	8 KB	Reserved	
Data	0x3FF4_F000	0x3FF4_FFFF	4 KB	I2S0	
Data	0x3FF5_0000	0x3FF5_0FFF	4 KB	UART1	
	0x3FF5_1000	0x3FF5_2FFF	8 KB	Reserved	
Data	0x3FF5_3000	0x3FF5_3FFF	4 KB	I2C0	
Data	0x3FF5_4000	0x3FF5_4FFF	4 KB	UDMA0	

Bus Type	Boundary Address		Size	Target	Comment
	Low Address	High Address			
Data	0x3FF5_5000	0x3FF5_5FFF	4 KB	SDIO Slave	One of three parts
Data	0x3FF5_6000	0x3FF5_6FFF	4 KB	RMT	
Data	0x3FF5_7000	0x3FF5_7FFF	4 KB	PCNT	
Data	0x3FF5_8000	0x3FF5_8FFF	4 KB	SDIO Slave	One of three parts
Data	0x3FF5_9000	0x3FF5_9FFF	4 KB	LED PWM	
Data	0x3FF5_A000	0x3FF5_AFFF	4 KB	Efuse Controller	
Data	0x3FF5_B000	0x3FF5_BFFF	4 KB	Flash Encryption	
	0x3FF5_C000	0x3FF5_DFFF	8 KB	Reserved	
Data	0x3FF5_E000	0x3FF5_EFFF	4 KB	PWM0	
Data	0x3FF5_F000	0x3FF5_FFFF	4 KB	TIMG0	
Data	0x3FF6_0000	0x3FF6_0FFF	4 KB	TIMG1	
	0x3FF6_1000	0x3FF6_3FFF	12 KB	Reserved	
Data	0x3FF6_4000	0x3FF6_4FFF	4 KB	SPI2	
Data	0x3FF6_5000	0x3FF6_5FFF	4 KB	SPI3	
Data	0x3FF6_6000	0x3FF6_6FFF	4 KB	SYSCON	
Data	0x3FF6_7000	0x3FF6_7FFF	4 KB	I2C1	
Data	0x3FF6_8000	0x3FF6_8FFF	4 KB	SDMMC	
Data	0x3FF6_9000	0x3FF6_AFFF	8 KB	EMAC	
	0x3FF6_B000	0x3FF6_BFFF	4 KB	Reserved	
Data	0x3FF6_C000	0x3FF6_CFFF	4 KB	PWM1	
Data	0x3FF6_D000	0x3FF6_DFFF	4 KB	I2S1	
Data	0x3FF6_E000	0x3FF6_EFFF	4 KB	UART2	
Data	0x3FF6_F000	0x3FF6_FFFF	4 KB	PWM2	
Data	0x3FF7_0000	0x3FF7_0FFF	4 KB	PWM3	
	0x3FF7_1000	0x3FF7_4FFF	16 KB	Reserved	
Data	0x3FF7_5000	0x3FF7_5FFF	4 KB	RNG	
	0x3FF7_6000	0x3FF7_FFFF	40 KB	Reserved	

1.3.4.1 Asymmetric PID Controller Peripheral

There are two PID Controllers in the system. They serve the PRO_CPU and the APP_CPU, respectively. **The PRO_CPU and the APP_CPU can only access their own PID Controller and not their counterpart's PID Controller.** Each CPU uses the same memory range 0x3FF1_F000 ~ 3FF1_FFFF to access its own PID Controller.

1.3.4.2 Non-Contiguous Peripheral Memory Ranges

The SDIO Slave peripheral consists of three parts and the two CPUs use non-contiguous addresses to access these. The three parts are accessed at the address ranges 0x3FF4_B000 ~ 3FF4_BFFF, 0x3FF5_5000 ~ 3FF5_5FFF and 0x3FF5_8000 ~ 3FF5_8FFF of each CPU's data bus. Similar to other peripherals, access to this peripheral is identical for both CPUs.

1.3.4.3 Memory Speed

The ROM as well as the SRAM are both clocked from CPU_CLK and can be accessed by the CPU in a single cycle. The RTC FAST memory is clocked from the APB_CLOCK and the RTC SLOW memory from the FAST_CLOCK, so access to these memories may be slower. DMA uses the APB_CLK to access memory.

Internally, the SRAM is organized in 32K-sized banks. Each CPU and DMA channel can access the SRAM at full speed and simultaneously, provided they access address different memory banks.

2. Interrupt Matrix

2.1 Introduction

The Interrupt Matrix embedded in the ESP32 independently allocates peripheral interrupt sources to the two CPUs' peripheral interrupts. This configuration is highly flexible in order to meet many different needs.

2.2 Features

- Accepts 71 peripheral interrupt sources as input.
- Generates 26 peripheral interrupt sources per CPU as output (52 total).
- CPU NMI Interrupt Mask.
- Queries current interrupt status of peripheral interrupt sources.

The structure of the Interrupt Matrix is shown in Figure 3.

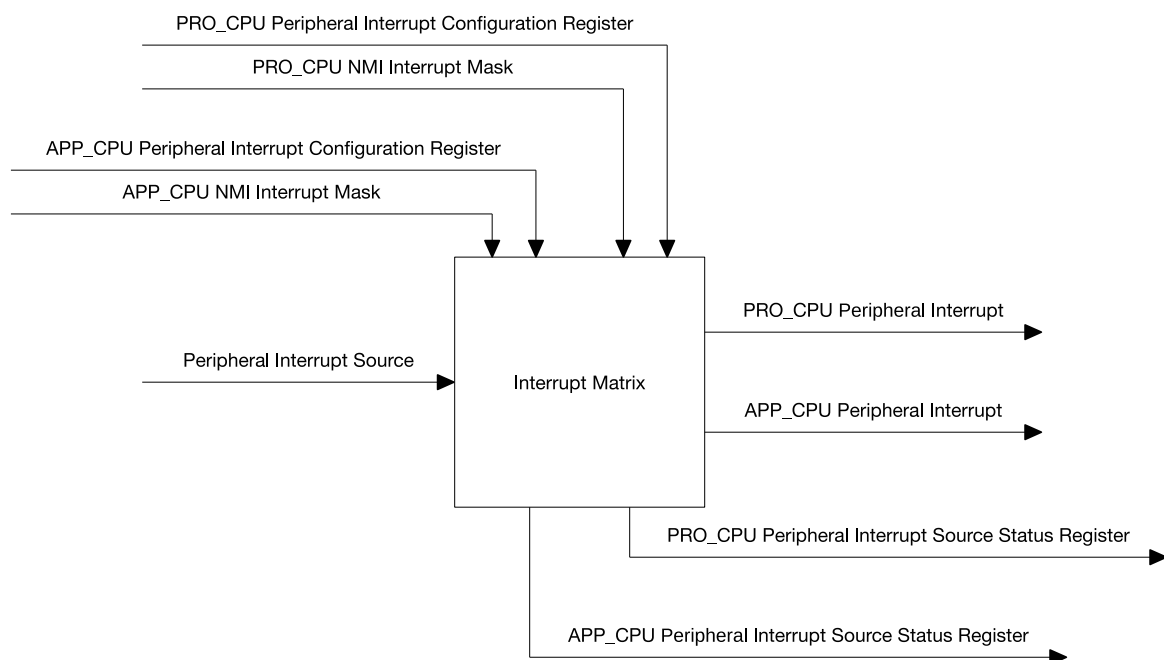

Figure 3: Interrupt Matrix Structure

2.3 Functional Description

2.3.1 Peripheral Interrupt Source

ESP32 has 71 peripheral interrupt sources in total. All peripheral interrupt sources are listed in table 6. 67 of 71 ESP32 peripheral interrupt sources can be allocated to either CPU.

The four remaining peripheral interrupt sources are CPU-specific, two per CPU. GPIO_INTERRUPT_PRO and GPIO_INTERRUPT_PRO_NMI can only be allocated to PRO_CPU. GPIO_INTERRUPT_APP and GPIO_INTERRUPT_APP_NMI can only be allocated to APP_CPU. As a result, PRO_CPU and APP_CPU each have 69 peripheral interrupt sources.

Table 6: PRO_CPU, APP_CPU interrupt configuration

PRO_CPU				APP_CPU			
Peripheral Interrupt Configuration Register	Bit	Status Register Name	Peripheral Interrupt Source		Status Register Name	Bit	Peripheral Interrupt Configuration Register
			No.	Name			
PRO_MAC_INTR_MAP_REG	0	PRO_INTR_STATUS_REG_0	0	MAC_INTR	0	APP_INTR_STATUS_REG_0	APP_MAC_INTR_MAP_REG
PRO_MAC_NMI_MAP_REG	1		1	MAC_NMI	1		APP_MAC_NMI_MAP_REG
PRO_BB_INT_MAP_REG	2		2	BB_INT	2		APP_BB_INT_MAP_REG
PRO_BT_MAC_INT_MAP_REG	3		3	BT_MAC_INT	3		APP_BT_MAC_INT_MAP_REG
PRO_BT_BB_INT_MAP_REG	4		4	BT_BB_INT	4		APP_BT_BB_INT_MAP_REG
PRO_BT_BB_NMI_MAP_REG	5		5	BT_BB_NMI	5		APP_BT_BB_NMI_MAP_REG
PRO_RWB_T_IRQ_MAP_REG	6		6	RWB_T_IRQ	6		APP_RWB_T_IRQ_MAP_REG
PRO_BT_BB_NMI_MAP_REG	5		5	BT_BB_NMI	5		APP_BT_BB_NMI_MAP_REG
PRO_RWB_T_IRQ_MAP_REG	6		6	RWB_T_IRQ	6		APP_RWB_T_IRQ_MAP_REG
PRO_RWBLE_IRQ_MAP_REG	7		7	RWBLE_IRQ	7		APP_RWBLE_IRQ_MAP_REG
PRO_RWB_T_NMI_MAP_REG	8		8	RWB_T_NMI	8		APP_RWB_T_NMI_MAP_REG
PRO_RWBLE_NMI_MAP_REG	9		9	RWBLE_NMI	9		APP_RWBLE_NMI_MAP_REG
PRO_SLCO_INTR_MAP_REG	10		10	SLCO_INTR	10		APP_SLCO_INTR_MAP_REG
PRO_SL_C1_INTR_MAP_REG	11		11	SLC1_INTR	11		APP_SL_C1_INTR_MAP_REG
PRO_UHCIO_INTR_MAP_REG	12		12	UHCIO_INTR	12		APP_UHCIO_INTR_MAP_REG
PRO_UHC1_INTR_MAP_REG	13		13	UHC1_INTR	13		APP_UHC1_INTR_MAP_REG
PRO_TG_TO_LEVEL_INT_MAP_REG	14		14	TG_TO_LEVEL_INT	14		APP_TG_TO_LEVEL_INT_MAP_REG
PRO_TG_T1_LEVEL_INT_MAP_REG	15		15	TG_T1_LEVEL_INT	15		APP_TG_T1_LEVEL_INT_MAP_REG
PRO_TG_WDT_LEVEL_INT_MAP_REG	16		16	TG_WDT_LEVEL_INT	16		APP_TG_WDT_LEVEL_INT_MAP_REG
PRO_TG_LACT_LEVEL_INT_MAP_REG	17		17	TG_LACT_LEVEL_INT	17		APP_TG_LACT_LEVEL_INT_MAP_REG
PRO_TG1_TO_LEVEL_INT_MAP_REG	18		18	TG1_TO_LEVEL_INT	18		APP_TG1_TO_LEVEL_INT_MAP_REG
PRO_TG1_T1_LEVEL_INT_MAP_REG	19		19	TG1_T1_LEVEL_INT	19		APP_TG1_T1_LEVEL_INT_MAP_REG
PRO_TG1_WDT_LEVEL_INT_MAP_REG	20	20	TG1_WDT_LEVEL_INT	20	APP_TG1_WDT_LEVEL_INT_MAP_REG		
PRO_TG1_LACT_LEVEL_INT_MAP_REG	21	21	TG1_LACT_LEVEL_INT	21	APP_TG1_LACT_LEVEL_INT_MAP_REG		
PRO_GPIO_INTERRUPT_PRO_MAP_REG	22		22	GPIO_INTERRUPT_PRO	22	APP_GPIO_INTERRUPT_APP_MAP_REG	
PRO_GPIO_INTERRUPT_PRO_NMI_MAP_REG	23		23	GPIO_INTERRUPT_PRO_NMI	23	APP_GPIO_INTERRUPT_APP_NMI_MAP_REG	
PRO_CPU_INTR_FROM_CPU_0_MAP_REG	24		24	CPU_INTR_FROM_CPU_0	24	APP_CPU_INTR_FROM_CPU_0_MAP_REG	
PRO_CPU_INTR_FROM_CPU_1_MAP_REG	25		25	CPU_INTR_FROM_CPU_1	25	APP_CPU_INTR_FROM_CPU_1_MAP_REG	
PRO_CPU_INTR_FROM_CPU_2_MAP_REG	26		26	CPU_INTR_FROM_CPU_2	26	APP_CPU_INTR_FROM_CPU_2_MAP_REG	
PRO_CPU_INTR_FROM_CPU_3_MAP_REG	27		27	CPU_INTR_FROM_CPU_3	27	APP_CPU_INTR_FROM_CPU_3_MAP_REG	
PRO_SPI_INTR_0_MAP_REG	28		28	SPI_INTR_0	28	APP_SPI_INTR_0_MAP_REG	
PRO_SPI_INTR_1_MAP_REG	29		29	SPI_INTR_1	29	APP_SPI_INTR_1_MAP_REG	
PRO_SPI_INTR_2_MAP_REG	30		30	SPI_INTR_2	30	APP_SPI_INTR_2_MAP_REG	
PRO_SPI_INTR_3_MAP_REG	31		31	SPI_INTR_3	31	APP_SPI_INTR_3_MAP_REG	
PRO_I2S0_INT_MAP_REG	0	PRO_INTR_STATUS_REG_1	32	I2S0_INT	32	APP_I2S0_INT_MAP_REG	
PRO_I2S1_INT_MAP_REG	1		33	I2S1_INT	33	APP_I2S1_INT_MAP_REG	
PRO_UART_INTR_MAP_REG	2		34	UART_INTR	34	APP_UART_INTR_MAP_REG	
PRO_UART1_INTR_MAP_REG	3		35	UART1_INTR	35	APP_UART1_INTR_MAP_REG	
PRO_UART2_INTR_MAP_REG	4		36	UART2_INTR	36	APP_UART2_INTR_MAP_REG	
PRO_SDIO_HOST_INTERRUPT_MAP_REG	5		37	SDIO_HOST_INTERRUPT	37	APP_SDIO_HOST_INTERRUPT_MAP_REG	
PRO_EMAC_INT_MAP_REG	6		38	EMAC_INT	38	APP_EMAC_INT_MAP_REG	
PRO_PWM0_INTR_MAP_REG	7		39	PWM0_INTR	39	APP_PWM0_INTR_MAP_REG	
PRO_PWM1_INTR_MAP_REG	8		40	PWM1_INTR	40	APP_PWM1_INTR_MAP_REG	
PRO_PWM2_INTR_MAP_REG	9		41	PWM2_INTR	41	APP_PWM2_INTR_MAP_REG	
PRO_PWM3_INTR_MAP_REG	10		42	PWM3_INTR	42	APP_PWM3_INTR_MAP_REG	
PRO_LEDC_INT_MAP_REG	11		43	LEDC_INT	43	APP_LEDC_INT_MAP_REG	
PRO_EFUSE_INT_MAP_REG	12		44	EFUSE_INT	44	APP_EFUSE_INT_MAP_REG	
PRO_CAN_INT_MAP_REG	13		45	CAN_INT	45	APP_CAN_INT_MAP_REG	
PRO_RTC_CORE_INTR_MAP_REG	14		46	RTC_CORE_INTR	46	APP_RTC_CORE_INTR_MAP_REG	
PRO_RMT_INTR_MAP_REG	15		47	RMT_INTR	47	APP_RMT_INTR_MAP_REG	
PRO_PCNT_INTR_MAP_REG	16		48	PCNT_INTR	48	APP_PCNT_INTR_MAP_REG	
PRO_I2C_EXT0_INTR_MAP_REG	17		49	I2C_EXT0_INTR	49	APP_I2C_EXT0_INTR_MAP_REG	
PRO_I2C_EXT1_INTR_MAP_REG	18		50	I2C_EXT1_INTR	50	APP_I2C_EXT1_INTR_MAP_REG	
PRO_RSA_INTR_MAP_REG	19		51	RSA_INTR	51	APP_RSA_INTR_MAP_REG	
PRO_SPI1_DMA_INT_MAP_REG	20		52	SPI1_DMA_INT	52	APP_SPI1_DMA_INT_MAP_REG	

Peripheral Interrupt Configuration Register	PRO_CPU				APP_CPU					
	Bit	Status Register Name	Peripheral Interrupt Source		No.	Status Register Name	Bit			
			No.	Name						
PRO_SPI2_DMA_INT_MAP_REG	21	PRO_INTR_STATUS_REG_1	53	SPI2_DMA_INT	53	APP_INTR_STATUS_REG_1	21	APP_SPI2_DMA_INT_MAP_REG		
PRO_SPI3_DMA_INT_MAP_REG	22		54	SPI3_DMA_INT	54		22	APP_SPI3_DMA_INT_MAP_REG		
PRO_WDG_INT_MAP_REG	23		55	WDG_INT	55		23	APP_WDG_INT_MAP_REG		
PRO_TIMER_INT1_MAP_REG	24		56	TIMER_INT1	56		24	APP_TIMER_INT1_MAP_REG		
PRO_TIMER_INT2_MAP_REG	25		57	TIMER_INT2	57		25	APP_TIMER_INT2_MAP_REG		
PRO_TG_T0_EDGE_INT_MAP_REG	26		58	TG_T0_EDGE_INT	58		26	APP_TG_T0_EDGE_INT_MAP_REG		
PRO_TG_T1_EDGE_INT_MAP_REG	27		59	TG_T1_EDGE_INT	59		27	APP_TG_T1_EDGE_INT_MAP_REG		
PRO_TG_WDT_EDGE_INT_MAP_REG	28		60	TG_WDT_EDGE_INT	60		28	APP_TG_WDT_EDGE_INT_MAP_REG		
PRO_TG_LACT_EDGE_INT_MAP_REG	29		61	TG_LACT_EDGE_INT	61		29	APP_TG_LACT_EDGE_INT_MAP_REG		
PRO_TG1_T0_EDGE_INT_MAP_REG	30		62	TG1_T0_EDGE_INT	62		30	APP_TG1_T0_EDGE_INT_MAP_REG		
PRO_TG1_T1_EDGE_INT_MAP_REG	31		63	TG1_T1_EDGE_INT	63		31	APP_TG1_T1_EDGE_INT_MAP_REG		
PRO_TG1_WDT_EDGE_INT_MAP_REG	0		PRO_INTR_STATUS_REG_2	64	TG1_WDT_EDGE_INT		64	APP_INTR_STATUS_REG_2	0	APP_TG1_WDT_EDGE_INT_MAP_REG
PRO_TG1_LACT_EDGE_INT_MAP_REG	1			65	TG1_LACT_EDGE_INT		65		1	APP_TG1_LACT_EDGE_INT_MAP_REG
PRO_MMU_IA_INT_MAP_REG	2			66	MMU_IA_INT		66		2	APP_MMU_IA_INT_MAP_REG
PRO_MPU_IA_INT_MAP_REG	3			67	MPU_IA_INT		67		3	APP_MPU_IA_INT_MAP_REG
PRO_CACHE_IA_INT_MAP_REG	4	68	CACHE_IA_INT	68	4	APP_CACHE_IA_INT_MAP_REG				

2.3.2 CPU Interrupt

Both of the two CPUs (PRO and APP) have 32 interrupts each, of which 26 are peripheral interrupts. All interrupts in a CPU are listed in Table 7.

Table 7: CPU Interrupts

No.	Category	Type	Priority Level
0	Peripheral	Level-Triggered	1
1	Peripheral	Level-Triggered	1
2	Peripheral	Level-Triggered	1
3	Peripheral	Level-Triggered	1
4	Peripheral	Level-Triggered	1
5	Peripheral	Level-Triggered	1
6	Internal	Timer.0	1
7	Internal	Software	1
8	Peripheral	Level-Triggered	1
9	Peripheral	Level-Triggered	1
10	Peripheral	Edge-Triggered	1
11	Internal	Profiling	3
12	Peripheral	Level-Triggered	1
13	Peripheral	Level-Triggered	1
14	Peripheral	NMI	NMI
15	Internal	Timer.1	3
16	Internal	Timer.2	5
17	Peripheral	Level-Triggered	1
18	Peripheral	Level-Triggered	1
19	Peripheral	Level-Triggered	2
20	Peripheral	Level-Triggered	2
21	Peripheral	Level-Triggered	2
22	Peripheral	Edge-Triggered	3
23	Peripheral	Level-Triggered	3
24	Peripheral	Level-Triggered	4
25	Peripheral	Level-Triggered	4
26	Peripheral	Level-Triggered	5
27	Peripheral	Level-Triggered	3
28	Peripheral	Edge-Triggered	4
29	Internal	Software	3
30	Peripheral	Edge-Triggered	4
31	Peripheral	Level-Triggered	5

2.3.3 Allocate Peripheral Interrupt Sources to Peripheral Interrupt on CPU

In this section:

- Source_X stands for any particular peripheral interrupt source.
- PRO_X_MAP_REG (or APP_X_MAP_REG) stands for any particular peripheral interrupt configuration

register of the PRO_CPU (or APP_CPU). The peripheral interrupt configuration register corresponds to the peripheral interrupt source Source_X. Referring to Table 6, the registers listed under “PRO_CPU (APP_CPU) - Peripheral Interrupt Configuration Register” correspond to the peripheral interrupt sources listed in “Peripheral Interrupt Source - Name”.

- Interrupt_P stands for CPU peripheral interrupt, numbered as Num_P. Num_P can take the ranges 0 ~ 5, 8 ~ 10, 12 ~ 14, 17 ~ 28, 30 ~ 31.
- Interrupt_I stands for CPU internal interrupt numbered as Num_I. Num_I can take values 6, 7, 11, 15, 16, 29.

Using this terminology, the possible operations of the Interrupt Matrix controller can be described as follows:

- **Allocate peripheral interrupt source Source_X to CPU (PRO_CPU or APP_CPU)**
Set PRO_X_MAP_REG or APP_X_MAP_REG to Num_P. Num_P can be any CPU peripheral interrupt number. CPU interrupts can be shared between multiple peripherals (see below).
- **Disable peripheral interrupt source Source_X for CPU (PRO_CPU or APP_CPU)**
Set PRO_X_MAP_REG or APP_X_MAP_REG for peripheral interrupt source to any Num_I. The specific choice of internal interrupt number does not change behaviour, as none of the interrupt numbered as Num_I are connected to either CPU.
- **Allocate multiple peripheral sources Source_X_n ORed to PRO_CPU (APP_CPU) peripheral interrupt**
Set multiple PRO_X_n_MAP_REG (APP_X_n_MAP_REG) to the same Num_P. Any of these peripheral interrupts will trigger CPU Interrupt_P.

2.3.4 CPU NMI Interrupt Mask

The Interrupt Matrix temporarily masks all peripheral interrupt sources allocated to PRO_CPU's (or APP_CPU's) NMI interrupt if it receives the signal PRO_CPU NMI Interrupt Mask (or APP_CPU NMI Interrupt Mask) from the peripheral PID Controller respectively.

2.3.5 Query Current Interrupt Status of Peripheral Interrupt Source

The current interrupt status of a peripheral interrupt source can be read via the bit value in PRO_INTR_STATUS_REG_n (APP_INTR_STATUS_REG_n) as shown in the mapping in Table 6.

3. Reset and Clock

3.1 System Reset

3.1.1 Introduction

The ESP32 has three reset levels: CPU reset, Core reset, and System reset. None of these reset levels clear the RAM. Figure 4 shows the subsystems included in each reset level.

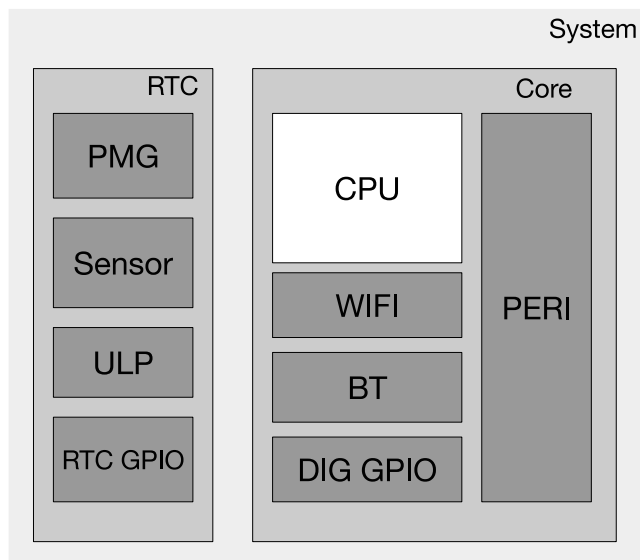

Figure 4: System Reset

- CPU reset: Only resets the registers of one or both the CPU cores.
- Core reset: Resets all the digital registers, including CPU cores, external GPIO and digital GPIO. The RTC is not reset.
- System reset: Resets all the registers on the chip, including those of the RTC.

3.1.2 Reset Source

While most of the time the APP_CPU and PRO_CPU will be reset simultaneously, some reset sources are able to reset only one of the two cores. The reset reason for each core can be looked up individually: the PRO_CPU reset reason will be stored in RTC_CNTL_RESET_CAUSE_PROCPU, the reset reason for the APP_CPU in APP_CNTL_RESET_CAUSE_PROCPU. Table 8 shows the possible reset reason values that can be read from these registers.

Table 8: PRO_CPU and APP_CPU reset reason values

PRO	APP	Source	Reset Type	Note
0x01	0x01	Chip Power On Reset	System Reset	-
0x10	0x10	RWDT System Reset	System Reset	Refer to WDT Chapter .
0x0F	0x0F	Brown Out Reset	System Reset	Refer to Power Management Chapter.
0x03	0x03	Software System Reset	Core Reset	Configure RTC_CNTL_SW_SYS_RST register.
0x05	0x05	Deep Sleep Rest	Core Reset	Refer to Power Management Chapter.
0x07	0x07	MWDT0 Global Reset	Core Reset	Refer to WDT Chapter .

PRO	APP	APP Source	Reset Type	Note
0x08	0x08	MWDT1 Global Reset	Core Reset	Refer to WDT Chapter .
0x09	0x09	RWDT Core Reset	Core Reset	Refer to WDT Chapter .
0x0B	-	MWDT0 CPU Reset	CPU Reset	Refer to WDT Chapter .
0x0C	-	Software CPU Reset	CPU Reset	Configure RTC_CNTL_SW_APPCPU_RST register.
-	0x0B	MWDT1 CPU Reset	CPU Reset	Refer to WDT Chapter .
-	0x0C	Software CPU Reset	CPU Reset	Configure RTC_CNTL_SW_APPCPU_RST register.
0x0D	0x0D	RWDT CPU Reset	CPU Reset	Refer to WDT Chapter .
-	0xE	PRO CPU Reset	CPU Reset	Indicates that the PRO CPU has independently reset the APP CPU by configuring the DPORT_APPCPU_RESETTING register.

3.2 System Clock

3.2.1 Introduction

The ESP32 integrates multiple clock sources for the CPU cores, the peripherals and the RTC. These clocks can be configured to meet different requirements. Figure 5 shows the system clock structure.

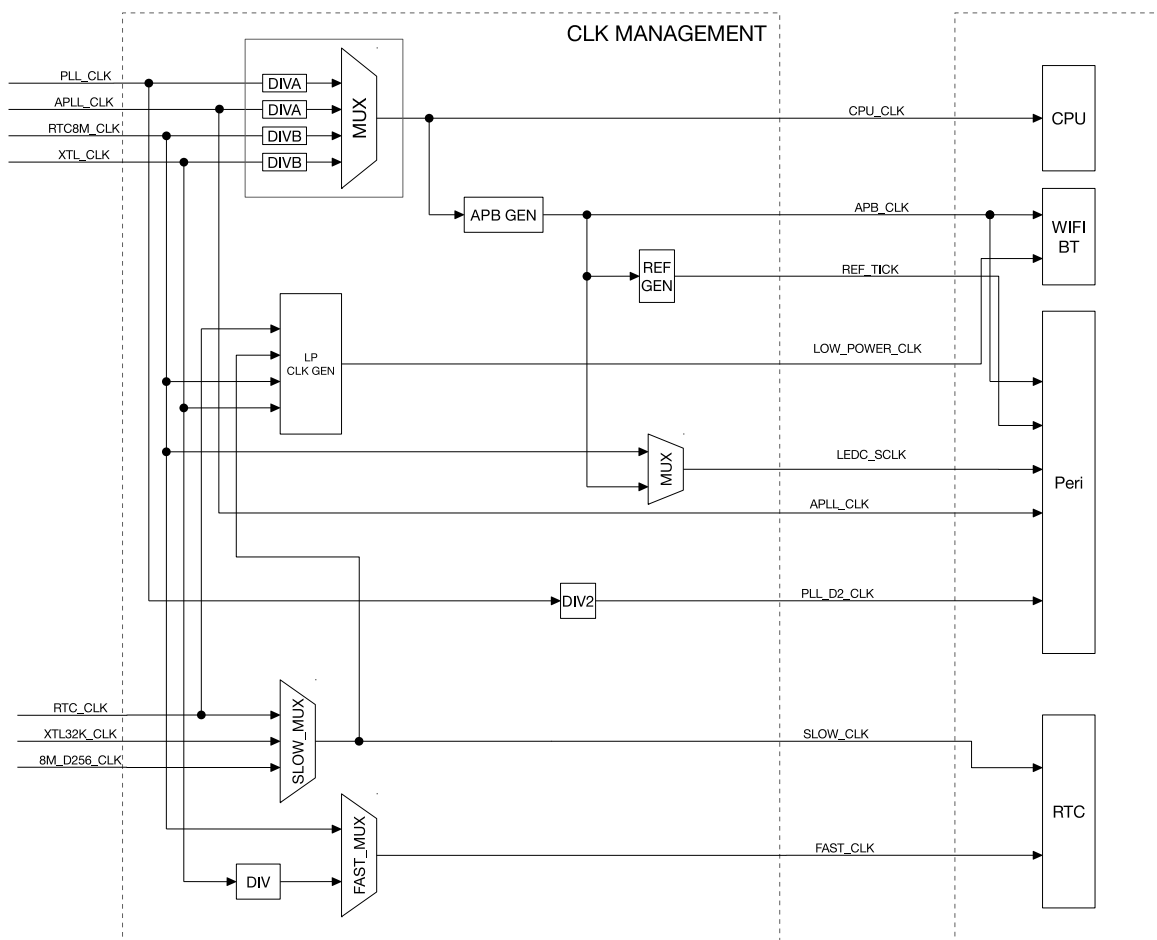

Figure 5: System Clock

3.2.2 Clock Source

The ESP32 can use an external crystal oscillator, an internal PLL or an oscillating circuit as a clock source. Specifically, the clock sources available are:

- High Speed Clocks
 - PLL_CLK is an internal PLL clock with a frequency of 320 MHz.
 - XTL_CLK is a clock signal generated using an external crystal with a frequency range of 2 ~ 40 MHz.
- Low Power Clocks
 - XTL32K_CLK is a clock generated using an external crystal with a frequency of 32 KHz.
 - RTC8M_CLK is an internal clock with a default frequency of 8 MHz. This frequency is adjustable.
 - RTC8M_D256_CLK is divided from RTC8M_CLK 256. Its frequency is (RTC8M_CLK / 256). With the default RTC8M_CLK frequency of 8 MHz, this clock runs at 31.250 KHz.
 - RTC_CLK is an internal low power clock with a default frequency of 150 KHz. This frequency is adjustable.
- Audio Clock
 - APLL_CLK is an internal Audio PLL clock with a frequency range of 16 ~ 128 MHz.

3.2.3 CPU Clock

As Figure 5 shows, CPU_CLK is the master clock for both CPU cores. CPU_CLK clock can be as high as 160 MHz when the CPU is in high performance mode. Alternatively, the CPU can run at lower frequencies to reduce power consumption.

The CPU_CLK clock source is determined by the RTC_CNTL_SOC_CLK_SEL register. PLL_CLK, APLL_CLK, RTC8M_CLK and XTL_CLK can be set as the CPU_CLK source; see Table 9 and 10.

Table 9: CPU_CLK Source

RTC_CNTL_SOC_CLK_SEL Value	Clock Source
0	XTL_CLK
1	PLL_CLK
2	RTC8M_CLK
3	APLL_CLK

Table 10: CPU_CLK Derivation

Clock Source	SEL*	CPU Clock
0 / XTL_CLK	-	CPU_CLK = XTL_CLK / (APB_CTRL_PRE_DIV_CNT+1) APB_CTRL_PRE_DIV_CNT range is 0 ~ 1023. Default is 0.
1 / PLL_CLK	0	CPU_CLK = PLL_CLK / 4 CPU_CLK frequency is 80 MHz
1 / PLL_CLK	1	CPU_CLK = PLL_CLK / 2 CPU_CLK frequency is 160 MHz
2 / RTC8M_CLK	-	CPU_CLK = RTC8M_CLK / (APB_CTRL_PRE_DIV_CNT+1) APB_CTRL_PRE_DIV_CNT range is 0 ~ 1023. Default is 0.
3 / APLL_CLK	0	CPU_CLK = APLL_CLK / 4
3 / APLL_CLK	1	CPU_CLK = APLL_CLK / 2

*SEL: DPORT_CPUPERIOD_SEL value

3.2.4 Peripheral Clock

Peripheral clocks include APB_CLK, REF_TICK, LEDC_SCLK, APLL_CLK and PLL_D2_CLK.

Table 11 shows which clocks can be used by which peripherals.

Table 11: Peripheral Clock Usage

Peripherals	APB_CLK	REF_TICK	LEDC_SCLK	APLL_CLK	PLL_D2_CLK
EMAC	Y	N	N	Y	N
TIMG	Y	N	N	N	N
I2S	Y	N	N	Y	Y
UART	Y	Y	N	N	N
RMT	Y	Y	N	N	N
LED PWM	Y	Y	Y	N	N
PWM	Y	N	N	N	N
I2C	Y	N	N	N	N
SPI	Y	N	N	N	N
PCNT	Y	N	N	N	N
Efuse Controller	Y	N	N	N	N
SDIO Slave	Y	N	N	N	N
SDMMC	Y	N	N	N	N

3.2.4.1 APB_CLK Source

The APB_CLK is derived from CPU_CLK as detailed in Table 12. The division factor depends on the CPU_CLK source.

Table 12: APB_CLK Derivation

CPU_CLK Source	APB_CLK
PLL_CLK	PLL_CLK / 4
APLL_CLK	CPU_CLK / 2
XTAL_CLK	CPU_CLK
RTC8M_CLK	CPU_CLK

3.2.4.2 REF_TICK Source

REF_TICK is derived from APB_CLK via a divider. The divider value used depends on the APB_CLK source, which in turn depends on the CPU_CLK source.

By configuring correct divider values for each APB_CLK source, the user can ensure that the REF_TICK frequency does not change when CPU_CLK changes source causing the APB_CLK frequency to change.

Clock divider registers are shown in Table 13.

Table 13: REF_TICK Derivation

CPU_CLK & APB_CLK Source	Clock Divider Register
PLL_CLK	APB_CTRL_PLL_TICK_NUM
XTAL_CLK	APB_CTRL_XTAL_TICK_NUM
APLL_CLK	APB_CTRL_APLL_TICK_NUM
RTC8M_CLK	APB_CTRL_CK8M_TICK_NUM

3.2.4.3 LEDC_SCLK Source

The LEDC_SCLK clock source is selected by the LEDC_APB_CLK_SEL register, as shown in Table 14.

Table 14: LEDC_SCLK Derivation

LEDC_APB_CLK_SEL Value	LEDC_SCLK Source
1	RTC8M_CLK
0	APB_CLK

3.2.4.4 APLL_SCLK Source

The APLL_CLK is sourced from PLL_CLK, with its output frequency configured using the APLL configuration registers.

3.2.4.5 PLL_D2_CLK Source

PLL_D2_CLK is half the PLL_CLK frequency.

3.2.4.6 Clock Source Considerations

Most peripherals will operate using the APB_CLK frequency as a reference. When this frequency changes, the peripherals will need to update their clock configuration to operate at the same frequency after the change. Peripherals accessing REF_TICK can continue operating normally when switching clock sources, without changing clock source. Please refer to Table 11 for details.

The LED PWM module can use RTC8M_CLK as a clock source, meaning that it can be used when APB_CLK is disabled. In other words, when the system is in low power consumption mode (refer to power manager module), normal peripherals will be halted (APB_CLK is turned off), but the LED PWM can work normally via RTC8M_CLK.

3.2.5 Wi-Fi BT Clock

Wi-Fi and BT can only operate if APB_CLK has PLL_CLK as its clock source. Suspending PLL_CLK requires Wi-Fi and BT to both have entered low power consumption mode first.

For LOW_POWER_CLK, one of RTC_CLK, SLOW_CLK, RTC8M_CLK or XTL_CLK can be selected as the low power consumption mode clock source for Wi-Fi and BT.

3.2.6 RTC Clock

The clock sources of SLOW_CLK and FAST_CLK are low frequency clocks. The RTC module can operate when most other clocks are stopped.

SLOW_CLK is used to clock the Power Management module. It can be sourced from RTC_CLK, XTL32K_CLK or RTC8M_D256_CLK

FAST_CLK is used to clock the On-chip Sensor module. It can be sourced from a divided XTL_CLK or from RTC8M_CLK.

4. IO_MUX and GPIO Matrix

4.1 Introduction

The ESP32 chip features 40 physical GPIO pads. Some GPIO pads cannot be used or do not have the corresponding pin on the chip package. Each pad can be used as a general purpose I/O or can be connected to an internal peripheral signal. The IO_MUX, RTC IO_MUX and the GPIO matrix are responsible for routing signals from the peripherals to GPIO pads. Together these systems provide highly configurable I/O.

This chapter describes the signal selection and connection between the digital pads (FUNC_SEL, IE, OE, WPU, WDU, etc), 256 peripheral input/output signals (control signals: SIG_IN_SEL, SIG_OUT_SEL, IE, OE, etc), fast peripheral input/output signals (control signals: SIG_IN_SEL, SIG_OUT_SEL, IE, OE, etc), and RTC IO_MUX.

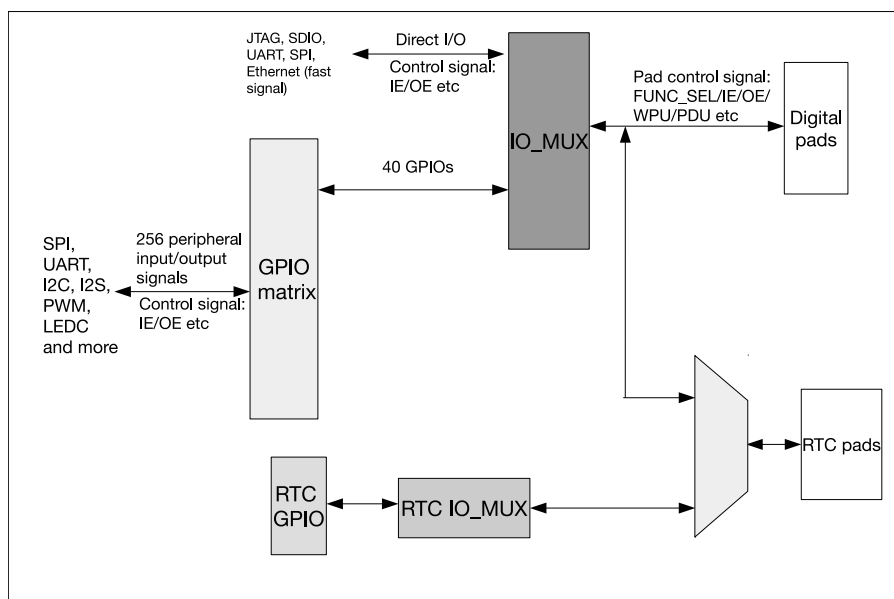

Figure 6: IO_MUX, RTC IO_MUX and GPIO Matrix Overview

1. The IO_MUX contains one register per GPIO pad. Each pad can be configured for "GPIO" function (connected to the GPIO Matrix) or configured for a direct function (bypassing the GPIO Matrix. Some high speed digital functions (Ethernet, SDIO, SPI, JTAG, UART) can bypass the GPIO Matrix for better high frequency digital performance. In this case, the IO_MUX is used to connect these pads directly to the peripheral.)

Refer to Section 4.10 for a list of IO_MUX functions for each I/O pad.

2. The GPIO Matrix is a full switching matrix between the peripheral input/output signals and the pads.
 - For input to the chip: Each of the 256 internal peripheral inputs can select any GPIO pad as the input source.
 - For output from the chip: The output signal of each of the 40 GPIO pads can be from one of the 256 peripheral output signals.

Refer to Section 4.9 for a list of GPIO Matrix peripheral signals.

3. RTC IO_MUX is used to connect GPIO pads to their low power and analog functions. Only a subset of GPIO pads have these optional "RTC" functions.

Refer to Section 4.11 for a list of RTC IO_MUX functions.

4.2 Peripheral Input via GPIO Matrix

4.2.1 Summary

To receive a peripheral input signal via the GPIO Matrix, the GPIO Matrix is configured to source the peripheral signal's input index (0-255) from one of the 40 GPIOs (0-39).

The input signal is read from the GPIO pad through the IO_MUX. The IO_MUX must be configured to set the chosen pad to "GPIO" function. This causes the GPIO pad input signal to be routed into the GPIO Matrix which in turn routes it to the selected peripheral input.

4.2.2 Functional Description

Figure 7 shows the logic for input selection via GPIO Matrix.

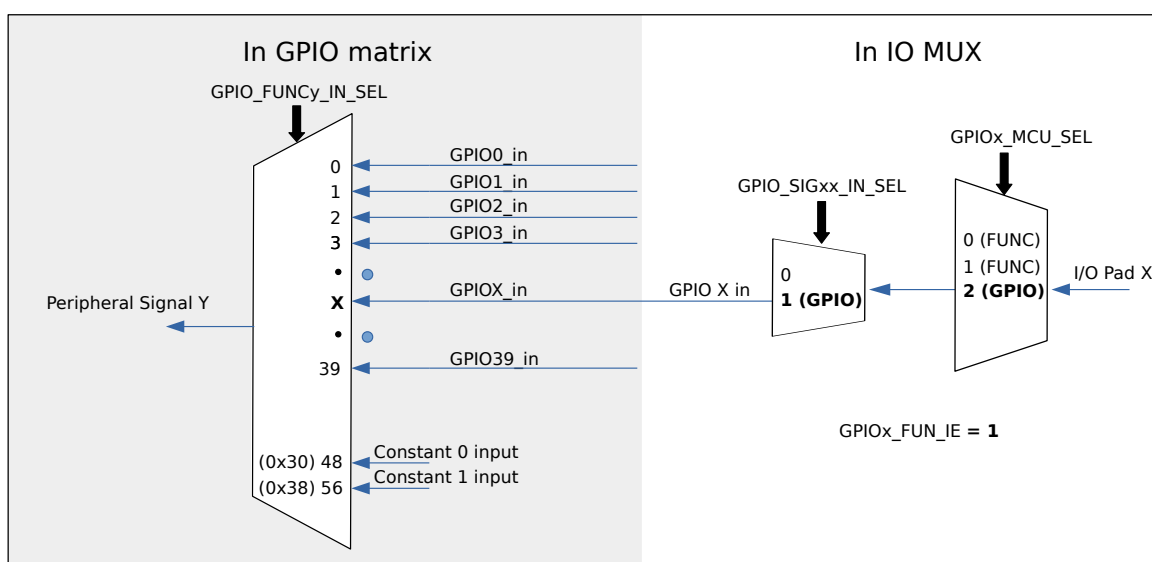

Figure 7: Peripheral Input via IO_MUX, GPIO Matrix

To read GPIO pad X into peripheral signal Y , follow these steps:

- Configure the `GPIO_FUNCy_IN_SEL_CFG` register for peripheral signal Y in the GPIO Matrix:
 - Set the `GPIO_FUNCx_IN_SEL` field to the number of the GPIO pad X to read from.
- Configure the `GPIO_FUNCx_OUT_SEL_CFG` and `GPIO_ENABLE_DATA[x]` for GPIO pad X in the GPIO Matrix:
 - For input only signals, the pad output can be disabled by setting the `GPIO_FUNCx_OEN_SEL` bits to one and `GPIO_ENABLE_DATA[x]` to zero. Otherwise, there is no need to disable output.
- Configure the IO_MUX register for GPIO pad X :
 - Set the function field to GPIO.
 - Enable the input by setting the `xx_FUN_IE` bit.
 - Set `xx_FUN_WPU` and `xx_FUN_WPD` fields as desired to enable internal pull-up/pull-down resistors.

Notes:

- One input pad can be connected to multiple input_signals.
- The input signal can be inverted with GPIO_FUNC x _IN_INV_SEL.
- It is possible to have a peripheral read a constant low or constant high input value without connecting this input to a pad. This can be done by selecting a special GPIO_FUNC y _IN_SEL input instead of a GPIO number:
 - When GPIO_FUNC x _IN_SEL is 0x30, input_signal x is always 0
 - When GPIO_FUNC x _IN_SEL is 0x38, input_signal x is always 1.

4.2.3 Simple GPIO Input

The GPIO_IN_DATA register holds the input values of each GPIO pad.

The input value of any GPIO pin can be read at any time without configuring the GPIO Matrix for a particular peripheral signal. However, it is necessary to configure the xx_FUN_IE register for pad X , as shown in Section 4.2.2.

4.3 Peripheral Output via GPIO Matrix

4.3.1 Summary

To output a signal from a peripheral via the GPIO Matrix, the GPIO Matrix is configured to route the peripheral output signal (0-255) to one of the first 34 GPIOs (0-33). (Note that GPIO pads 34-39 cannot be used as outputs.)

The output signal is routed from the peripheral into the GPIO Matrix. It is then routed into the IO_MUX, which is configured to set the chosen pad to "GPIO" function. This causes the output GPIO signal to be connected to the pad.

4.3.2 Functional Description

One of 256 input signals can be selected to go through the GPIO matrix into the IO_MUX and then to a pad. Figure 8 illustrates the configuration.

To output peripheral signal Y to particular GPIO pad X , follow these steps:

1. Configure the GPIO_FUNC x _OUT_SEL_CFG register and GPIO_ENABLE_DATA $[x]$ of GPIO X in the GPIO Matrix:
 - Set GPIO_FUNC x _OUT_SEL to the index of desired peripheral output signal Y .
 - Set the GPIO_FUNC x _OEN_SEL bits and GPIO_ENABLE_DATA $[x]$ to enable output mode by force, OR, clear GPIO_FUNC x _OEN_SEL to zero so that the output enable signal will be decided by the internal logic function.
2. Optionally, to enable open drain mode set the GPIO_PIN x _PAD_DRIVER bit in the GPIO_PIN x register.
3. Configure the I/O mux register for GPIO pad X :
 - Set the function field to GPIO.

- Set the `xx_FUN_DRV` field to the desired value for output strength. The higher the value is, the higher the output strength is. Pull up/down the pad by configuring `xx_FUNC_WPU` and `xx_FUNC_WPD` registers in open drain mode.

Notes:

- The output signal from a single peripheral can be sent to multiple pads simultaneously.
- Only the first 34 GPIOs (0-33) can be used as outputs.
- The output signal can be inverted by setting the `GPIO_FUNCx_OUT_INV_SEL` bit.

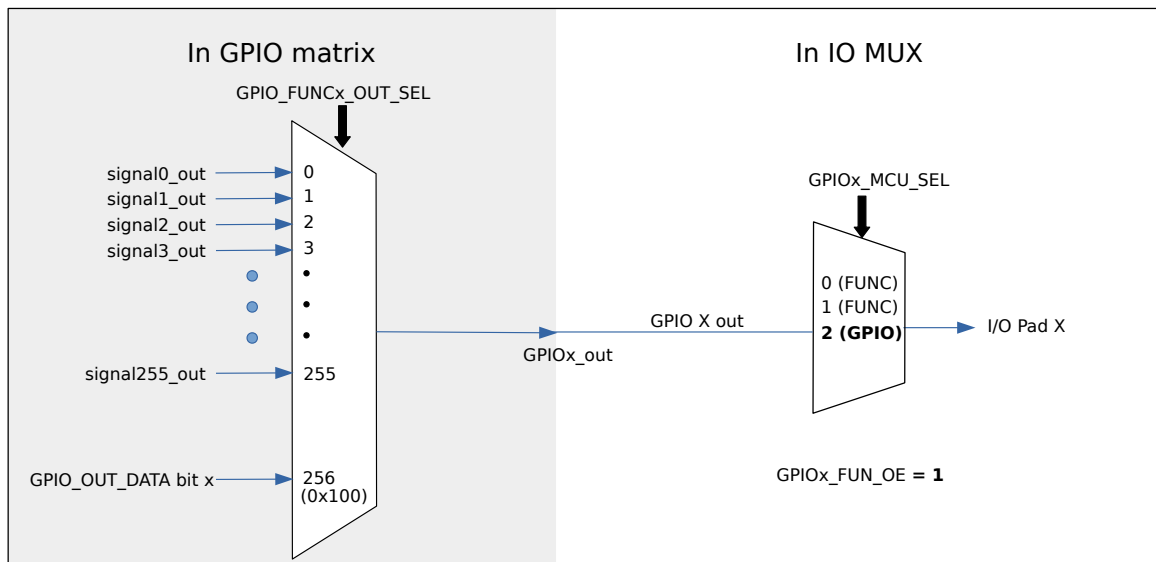

Figure 8: Output via GPIO Matrix

4.3.3 Simple GPIO Output

The GPIO Matrix can also be used for simple GPIO output - setting a bit in the `GPIO_OUT_DATA` register will write to the corresponding GPIO pad.

To configure a pad as simple GPIO output, the GPIO Matrix `GPIO_FUNCx_OUT_SEL` register is configured with a special peripheral index value (0x100).

4.4 Direct I/O via IO_MUX

4.4.1 Summary

Some high speed digital functions (Ethernet, SDIO, SPI, JTAG, UART) can bypass the GPIO Matrix for better high frequency digital performance. In this case, the `IO_MUX` is used to connect these pads directly to the peripheral.

Selecting this option is less flexible than using the GPIO Matrix, as the `IO_MUX` register for each GPIO pad can only select from a limited number of functions. However, better high frequency digital performance will be maintained.

4.4.2 Functional Description

Two registers must be configured in order to bypass the GPIO Matrix for peripheral I/O:

1. IO_MUX for the GPIO pad must be set to the desired pad function (Section 4.10 has a list of pad functions).
2. For inputs, the SIG_IN_SEL register must be set to route the input directly to the peripheral.

4.5 RTC IO_MUX for Low Power and Analog I/O

4.5.1 Summary

18 pins have low power (RTC domain) capabilities and analog functions which are handled by the RTC subsystem of ESP32. The IO_MUX and GPIO Matrix are not used for these functions, instead the RTC_MUX is used to redirect the I/O to the RTC subsystem.

When configured as RTC GPIOs, the output pads can still retain the output level value when the chip is in Deep-sleep mode, and the input pads can wake up the chip from Deep-sleep.

Section 4.11 has a list of RTC_MUX pins and their functions.

4.5.2 Functional Description

Each pad with analog and RTC functions is controlled by the RTC_IO_TOUCH_PAD x _TO_GPIO bit in the RTC_GPIO_PIN x register. By default this bit is set to 1, routing all I/O via the IO_MUX subsystem as described in earlier subsections.

If the RTC_IO_TOUCH_PAD x _TO_GPIO bit is cleared, then I/O to and from that pad is routed to the RTC subsystem instead. In this mode, the RTC_GPIO_PIN x register is used for digital I/O and the analog features of the pad are also available. See Section 4.11 for a list of RTC pin functions.

See 4.11 for a table mapping GPIO pads to their RTC equivalent pins and analog functions. Note that the RTC_IO_PIN x registers use the RTC GPIO pin numbering, not the GPIO pad numbering.

4.6 Light-sleep Mode Pin Functions

Pins can have different functions when the ESP32 is in Light-sleep mode. If the GPIO xx _SLP_SEL bit in the IO_MUX register for a GPIO pad is set to 1, a different set of registers is used to control the pad when the ESP32 is in Light-sleep mode:

Table 15: IO_MUX Light-sleep Pin Function Registers

IO_MUX Function	Normal Execution OR GPIO xx _SLP_SEL = 0	Light-sleep Mode AND GPIO xx _SLP_SEL = 1
Output Drive Strength	GPIO xx _FUNC_DRV	GPIO xx _MCU_DRV
Pullup Resistor	GPIO xx _FUNC_WPU	GPIO xx _MCU_WPU
Pulldown Resistor	GPIO xx _FUNC_WPD	GPIO xx _MCU_WPD
Output Enable	(From GPIO Matrix _OEN field)	GPIO xx _MCU_OE

If GPIO xx _SLP_SEL is set to 0, the pin functions remain the same in both normal execution and Light-sleep modes.

4.7 Pad Hold Feature

Each IO pad (including the RTC pads) has an individual hold function controlled by a RTC register. When the pad is set to hold, the state is latched at that moment and will not change no matter how the internal signals change or how the IO_MUX configuration or GPIO configuration is modified. Users can use the hold function for the pads to retain the pad state through a core reset and system reset triggered by watchdog time-out or Deep-sleep events.

4.8 I/O Pad Power Supply

IO pad power supply is shown in Figure 9.

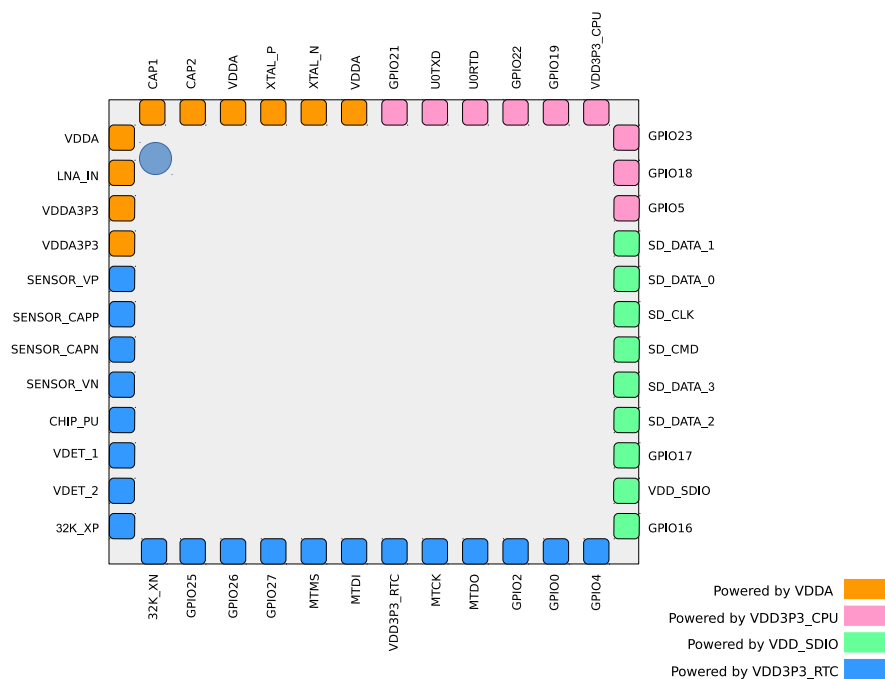

Figure 9: ESP32 I/O Pad Power Sources

- Pads marked blue are RTC pads that have their individual analog function and can also act as normal digital IO pads. For details, please refer to Section 4.11.
- Pads marked pink and green only have digital functions.
- Pads marked green can be powered externally or internally via VDD_SDIO (see below).

4.8.1 VDD_SDIO Power Domain

VDD_SDIO can source or sink current, allowing this power domain to be powered externally or internally. To power VDD_SDIO externally, apply the same power supply of VDD3P3_RTC to the VDD_SDIO pad.

Without an external power supply, the internal regulator will supply VDD_SDIO. The VDD_SDIO voltage can be configured to be either 1.8V or 3.3V (the same as that at VRTC), depending on the state of the MTDI pad at reset - a high level configures 1.8V and a low level configures 3.3V. Setting the efuse bit decides the default voltage of the VDD_SDIO. In addition, software can change the voltage of the VDD_SDIO by configuring register bits.

4.9 Peripheral Signal List

Table 16 contains a list of Peripheral Input/Output signals used by the GPIO Matrix:

Table 16: GPIO Matrix Peripheral Signals

Signal	Input Signal	Output Signal	Direct I/O in IO_MUX
0	SPICLK_in	SPICLK_out	YES
1	SPIQ_in	SPIQ_out	YES
2	SPID_in	SPID_out	YES
3	SPIHD_in	SPIHD_out	YES
4	SPIWP_in	SPIWP_out	YES
5	SPICS0_in	SPICS0_out	YES
6	SPICS1_in	SPICS1_out	
7	SPICS2_in	SPICS2_out	
8	HSPICLK_in	HSPICLK_out	YES
9	HSPIQ_in	HSPIQ_out	YES
10	HSPID_in	HSPID_out	YES
11	HSPICS0_in	HSPICS0_out	YES
12	HSPIHD_in	HSPIHD_out	YES
13	HSPIWP_in	HSPIWP_out	YES
14	U0RXD_in	U0TXD_out	YES
15	U0CTS_in	U0RTS_out	YES
16	U0DSR_in	U0DTR_out	
17	U1RXD_in	U1TXD_out	YES
18	U1CTS_in	U1RTS_out	YES
23	I2S0O_BCK_in	I2S0O_BCK_out	
24	I2S1O_BCK_in	I2S1O_BCK_out	
25	I2S0O_WS_in	I2S0O_WS_out	
26	I2S1O_WS_in	I2S1O_WS_out	
27	I2S0I_BCK_in	I2S0I_BCK_out	
28	I2S0I_WS_in	I2S0I_WS_out	
29	I2CEXT0_SCL_in	I2CEXT0_SCL_out	
30	I2CEXT0_SDA_in	I2CEXT0_SDA_out	
31	pwm0_sync0_in	sdio_tohost_int_out	
32	pwm0_sync1_in	pwm0_out0a	
33	pwm0_sync2_in	pwm0_out0b	
34	pwm0_f0_in	pwm0_out1a	
35	pwm0_f1_in	pwm0_out1b	
36	pwm0_f2_in	pwm0_out2a	
37		pwm0_out2b	
39	pcnt_sig_ch0_in0		
40	pcnt_sig_ch1_in0		
41	pcnt_ctrl_ch0_in0		
42	pcnt_ctrl_ch1_in0		
43	pcnt_sig_ch0_in1		
44	pcnt_sig_ch1_in1		

Signal	Input Signal	Output Signal	Direct I/O in IO_MUX
45	pcnt_ctrl_ch0_in1		
46	pcnt_ctrl_ch1_in1		
47	pcnt_sig_ch0_in2		
48	pcnt_sig_ch1_in2		
49	pcnt_ctrl_ch0_in2		
50	pcnt_ctrl_ch1_in2		
51	pcnt_sig_ch0_in3		
52	pcnt_sig_ch1_in3		
53	pcnt_ctrl_ch0_in3		
54	pcnt_ctrl_ch1_in3		
55	pcnt_sig_ch0_in4		
56	pcnt_sig_ch1_in4		
57	pcnt_ctrl_ch0_in4		
58	pcnt_ctrl_ch1_in4		
61	HSPICS1_in	HSPICS1_out	
62	HSPICS2_in	HSPICS2_out	
63	VSPICLK_in	VSPICLK_out_mux	YES
64	VSPIQ_in	VSPIQ_out	YES
65	VSPID_in	VSPID_out	YES
66	VSPiHD_in	VSPiHD_out	YES
67	VSPiWP_in	VSPiWP_out	YES
68	VSPICS0_in	VSPICS0_out	YES
69	VSPICS1_in	VSPICS1_out	
70	VSPICS2_in	VSPICS2_out	
71	pcnt_sig_ch0_in5	ledc_hs_sig_out0	
72	pcnt_sig_ch1_in5	ledc_hs_sig_out1	
73	pcnt_ctrl_ch0_in5	ledc_hs_sig_out2	
74	pcnt_ctrl_ch1_in5	ledc_hs_sig_out3	
75	pcnt_sig_ch0_in6	ledc_hs_sig_out4	
76	pcnt_sig_ch1_in6	ledc_hs_sig_out5	
77	pcnt_ctrl_ch0_in6	ledc_hs_sig_out6	
78	pcnt_ctrl_ch1_in6	ledc_hs_sig_out7	
79	pcnt_sig_ch0_in7	ledc_ls_sig_out0	
80	pcnt_sig_ch1_in7	ledc_ls_sig_out1	
81	pcnt_ctrl_ch0_in7	ledc_ls_sig_out2	
82	pcnt_ctrl_ch1_in7	ledc_ls_sig_out3	
83	rmt_sig_in0	ledc_ls_sig_out4	
84	rmt_sig_in1	ledc_ls_sig_out5	
85	rmt_sig_in2	ledc_ls_sig_out6	
86	rmt_sig_in3	ledc_ls_sig_out7	
87	rmt_sig_in4	rmt_sig_out0	
88	rmt_sig_in5	rmt_sig_out1	
89	rmt_sig_in6	rmt_sig_out2	
90	rmt_sig_in7	rmt_sig_out3	

Signal	Input Signal	Output Signal	Direct I/O in IO_MUX
91		rmt_sig_out4	
92		rmt_sig_out5	
93		rmt_sig_out6	
94		rmt_sig_out7	
95	I2CEXT1_SCL_in	I2CEXT1_SCL_out	
96	I2CEXT1_SDA_in	I2CEXT1_SDA_out	
97	host_card_detect_n_1	host_ccmd_od_pullup_en_n	
98	host_card_detect_n_2	host_rst_n_1	
99	host_card_write_prt_1	host_rst_n_2	
100	host_card_write_prt_2	gpio_sd0_out	
101	host_card_int_n_1	gpio_sd1_out	
102	host_card_int_n_2	gpio_sd2_out	
103	pwm1_sync0_in	gpio_sd3_out	
104	pwm1_sync1_in	gpio_sd4_out	
105	pwm1_sync2_in	gpio_sd5_out	
106	pwm1_f0_in	gpio_sd6_out	
107	pwm1_f1_in	gpio_sd7_out	
108	pwm1_f2_in	pwm1_out0a	
109	pwm0_cap0_in	pwm1_out0b	
110	pwm0_cap1_in	pwm1_out1a	
111	pwm0_cap2_in	pwm1_out1b	
112	pwm1_cap0_in	pwm1_out2a	
113	pwm1_cap1_in	pwm1_out2b	
114	pwm1_cap2_in	pwm2_out1h	
115	pwm2_flt_a	pwm2_out1l	
116	pwm2_flt_b	pwm2_out2h	
117	pwm2_cap1_in	pwm2_out2l	
118	pwm2_cap2_in	pwm2_out3h	
119	pwm2_cap3_in	pwm2_out3l	
120	pwm3_flt_a	pwm2_out4h	
121	pwm3_flt_b	pwm2_out4l	
122	pwm3_cap1_in		
123	pwm3_cap2_in		
124	pwm3_cap3_in		
140	I2S0I_DATA_in0	I2S0O_DATA_out0	
141	I2S0I_DATA_in1	I2S0O_DATA_out1	
142	I2S0I_DATA_in2	I2S0O_DATA_out2	
143	I2S0I_DATA_in3	I2S0O_DATA_out3	
144	I2S0I_DATA_in4	I2S0O_DATA_out4	
145	I2S0I_DATA_in5	I2S0O_DATA_out5	
146	I2S0I_DATA_in6	I2S0O_DATA_out6	
147	I2S0I_DATA_in7	I2S0O_DATA_out7	
148	I2S0I_DATA_in8	I2S0O_DATA_out8	
149	I2S0I_DATA_in9	I2S0O_DATA_out9	

Signal	Input Signal	Output Signal	Direct I/O in IO_MUX
150	I2S0I_DATA_in10	I2S0O_DATA_out10	
151	I2S0I_DATA_in11	I2S0O_DATA_out11	
152	I2S0I_DATA_in12	I2S0O_DATA_out12	
153	I2S0I_DATA_in13	I2S0O_DATA_out13	
154	I2S0I_DATA_in14	I2S0O_DATA_out14	
155	I2S0I_DATA_in15	I2S0O_DATA_out15	
156		I2S0O_DATA_out16	
157		I2S0O_DATA_out17	
158		I2S0O_DATA_out18	
159		I2S0O_DATA_out19	
160		I2S0O_DATA_out20	
161		I2S0O_DATA_out21	
162		I2S0O_DATA_out22	
163		I2S0O_DATA_out23	
164	I2S1I_BCK_in	I2S1I_BCK_out	
165	I2S1I_WS_in	I2S1I_WS_out	
166	I2S1I_DATA_in0	I2S1O_DATA_out0	
167	I2S1I_DATA_in1	I2S1O_DATA_out1	
168	I2S1I_DATA_in2	I2S1O_DATA_out2	
169	I2S1I_DATA_in3	I2S1O_DATA_out3	
170	I2S1I_DATA_in4	I2S1O_DATA_out4	
171	I2S1I_DATA_in5	I2S1O_DATA_out5	
172	I2S1I_DATA_in6	I2S1O_DATA_out6	
173	I2S1I_DATA_in7	I2S1O_DATA_out7	
174	I2S1I_DATA_in8	I2S1O_DATA_out8	
175	I2S1I_DATA_in9	I2S1O_DATA_out9	
176	I2S1I_DATA_in10	I2S1O_DATA_out10	
177	I2S1I_DATA_in11	I2S1O_DATA_out11	
178	I2S1I_DATA_in12	I2S1O_DATA_out12	
179	I2S1I_DATA_in13	I2S1O_DATA_out13	
180	I2S1I_DATA_in14	I2S1O_DATA_out14	
181	I2S1I_DATA_in15	I2S1O_DATA_out15	
182		I2S1O_DATA_out16	
183		I2S1O_DATA_out17	
184		I2S1O_DATA_out18	
185		I2S1O_DATA_out19	
186		I2S1O_DATA_out20	
187		I2S1O_DATA_out21	
188		I2S1O_DATA_out22	
189		I2S1O_DATA_out23	
190	I2S0I_H_SYNC	pwm3_out1h	
191	I2S0I_V_SYNC	pwm3_out1l	
192	I2S0I_H_ENABLE	pwm3_out2h	
193	I2S1I_H_SYNC	pwm3_out2l	

Signal	Input Signal	Output Signal	Direct I/O in IO_MUX
194	I2S1I_V_SYNC	pwm3_out3h	
195	I2S1I_H_ENABLE	pwm3_out3l	
196		pwm3_out4h	
197		pwm3_out4l	
198	U2RXD_in	U2TXD_out	YES
199	U2CTS_in	U2RTS_out	YES
200	emac_mdc_i	emac_mdc_o	
201	emac_mdi_i	emac_mdo_o	
202	emac_crs_i	emac_crs_o	
203	emac_col_i	emac_col_o	
204	pcmfsync_in	bt_audio0_irq	
205	pcmclk_in	bt_audio1_irq	
206	pcmdin	bt_audio2_irq	
207		ble_audio0_irq	
208		ble_audio1_irq	
209		ble_audio2_irq	
210		pcmfsync_out	
211		pcmclk_out	
212		pcmdout	
213		ble_audio_sync0_p	
214		ble_audio_sync1_p	
215		ble_audio_sync2_p	
224		sig_in_func224	
225		sig_in_func225	
226		sig_in_func226	
227		sig_in_func227	
228		sig_in_func228	

Direct I/O in IO_MUX "YES" means this signal is also available directly via IO_MUX. To apply GPIO Matrix for these signals, their corresponding SIG_IN_SEL register must be cleared.

4.10 IO_MUX Pad List

Table 17 shows the IO_MUX functions for each I/O pad:

Table 17: IO_MUX Pad Summary

GPIO	Pad Name	Function 1	Function 2	Function 3	Function 4	Function 5	Function 6	Reset	Notes
0	GPIO0	GPIO0	CLK_OUT1	GPIO0	-	-	EMAC_TX_CLK	3	R
1	U0TXD	U0TXD	CLK_OUT3	GPIO1	-	-	EMAC_RXD2	3	-
2	GPIO2	GPIO2	HSPIWP	GPIO2	HS2_DATA0	SD_DATA0	-	2	R
3	U0RXD	U0RXD	CLK_OUT2	GPIO3	-	-	-	3	-
4	GPIO4	GPIO4	HSPIHD	GPIO4	HS2_DATA1	SD_DATA1	EMAC_TX_ER	2	R
5	GPIO5	GPIO5	VSPICS0	GPIO5	HS1_DATA6	-	EMAC_RX_CLK	3	-
6	SD_CLK	SD_CLK	SPICLK	GPIO6	HS1_CLK	U1CTS	-	3	-
7	SD_DATA_0	SD_DATA0	SPIQ	GPIO7	HS1_DATA0	U2RTS	-	3	-
8	SD_DATA_1	SD_DATA1	SPID	GPIO8	HS1_DATA1	U2CTS	-	3	-

GPIO	Pad Name	Function 1	Function 2	Function 3	Function 4	Function 5	Function 6	Reset	Notes
9	SD_DATA_2	SD_DATA2	SPIHD	GPIO9	HS1_DATA2	U1RXD	-	3	-
10	SD_DATA_3	SD_DATA3	SPIWP	GPIO10	HS1_DATA3	U1TXD	-	3	-
11	SD_CMD	SD_CMD	SPICS0	GPIO11	HS1_CMD	U1RTS	-	3	-
12	MTDI	MTDI	HSPIQ	GPIO12	HS2_DATA2	SD_DATA2	EMAC_TXD3	2	R
13	MTCK	MTCK	HSPID	GPIO13	HS2_DATA3	SD_DATA3	EMAC_RX_ER	1	R
14	MTMS	MTMS	HSPICLK	GPIO14	HS2_CLK	SD_CLK	EMAC_TXD2	1	R
15	MTDO	MTDO	HSPICS0	GPIO15	HS2_CMD	SD_CMD	EMAC_RXD3	3	R
16	GPIO16	GPIO16	-	GPIO16	HS1_DATA4	U2RXD	EMAC_CLK_OUT	1	-
17	GPIO17	GPIO17	-	GPIO17	HS1_DATA5	U2TXD	EMAC_CLK_180	1	-
18	GPIO18	GPIO18	VSPICLK	GPIO18	HS1_DATA7	-	-	1	-
19	GPIO19	GPIO19	VSPIQ	GPIO19	U0CTS	-	EMAC_TXD0	1	-
20	GPIO20	GPIO20	-	GPIO20	-	-	-	1	-
21	GPIO21	GPIO21	VSPICLK	GPIO21	-	-	EMAC_TX_EN	1	-
22	GPIO22	GPIO22	VSPICLK	GPIO22	U0RTS	-	EMAC_TXD1	1	-
23	GPIO23	GPIO23	VSPID	GPIO23	HS1_STROBE	-	-	1	-
25	GPIO25	GPIO25	-	GPIO25	-	-	EMAC_RXD0	0	R
26	GPIO26	GPIO26	-	GPIO26	-	-	EMAC_RXD1	0	R
27	GPIO27	GPIO27	-	GPIO27	-	-	EMAC_RX_DV	1	R
32	32K_XP	GPIO32	-	GPIO32	-	-	-	0	R
33	32K_XN	GPIO33	-	GPIO33	-	-	-	0	R
34	VDET_1	GPIO34	-	GPIO34	-	-	-	0	R, I
35	VDET_2	GPIO35	-	GPIO35	-	-	-	0	R, I
36	SENSOR_VP	GPIO36	-	GPIO36	-	-	-	0	R, I
37	SENSOR_CAPP	GPIO37	-	GPIO37	-	-	-	0	R, I
38	SENSOR_CAPN	GPIO38	-	GPIO38	-	-	-	0	R, I
39	SENSOR_VN	GPIO39	-	GPIO39	-	-	-	0	R, I

Reset Configurations

"Reset" column shows each pad's default configurations after reset:

- **0** - IE=0 (input disabled).
- **1** - IE=1 (input enabled).
- **2** - IE=1, WPD=1 (input enabled, pulldown resistor).
- **3** - IE=1, WPU=1 (input enabled, pullup resistor).

Notes

- **R** - Pad has RTC/analog functions via RTC_MUX.
- **I** - Pad can only be configured as input GPIO.

Refer to [ESP32 Pin List](#) datasheet for more details and a complete table of pin functions.

4.11 RTC_MUX Pin List

Table 18 shows the RTC pins and how they correspond to GPIO pads:

Table 18: RTC_MUX Pin Summary

RTC GPIO Num	GPIO Num	Pad Name	Analog Function		
			1	2	3
0	36	SENSOR_VP	ADC_H	ADC1_CH0	-
1	37	SENSOR_CAPP	ADC_H	ADC1_CH1	-

RTC GPIO Num	GPIO Num	Pad Name	Analog Function		
			1	2	3
2	38	SENSOR_CAPN	ADC_H	ADC1_CH2	-
3	39	SENSOR_VN	ADC_H	ADC1_CH3	-
4	34	VDET_1	-	ADC1_CH6	-
5	35	VDET_2	-	ADC1_CH7	-
6	25	GPIO25	DAC_1	ADC2_CH8	-
7	26	GPIO26	DAC_2	ADC2_CH9	-
8	33	32K_XN	XTAL_32K_N	ADC1_CH5	TOUCH8
9	32	32K_XP	XTAL_32K_P	ADC1_CH4	TOUCH9
10	4	GPIO4	-	ADC2_CH0	TOUCH0
11	0	GPIO0	-	ADC2_CH1	TOUCH1
12	2	GPIO2	-	ADC2_CH2	TOUCH2
13	15	MTDO	-	ADC2_CH3	TOUCH3
14	13	MTCK	-	ADC2_CH4	TOUCH4
15	12	MTDI	-	ADC2_CH5	TOUCH5
16	14	MTMS	-	ADC2_CH6	TOUCH6
17	27	GPIO27	-	ADC2_CH7	TOUCH7

4.12 Register Summary

Name	Description	Address	Access
GPIO_OUT_REG	GPIO 0-31 output register_REG	0x3FF44004	R/W
GPIO_OUT_W1TS_REG	GPIO 0-31 output register_W1TS_REG	0x3FF44008	RO
GPIO_OUT_W1TC_REG	GPIO 0-31 output register_W1TC_REG	0x3FF4400C	RO
GPIO_OUT1_REG	GPIO 0-31 output register1_REG	0x3FF44010	R/W
GPIO_OUT1_W1TS_REG	GPIO 0-31 output register1_W1TS_REG	0x3FF44014	RO
GPIO_OUT1_W1TC_REG	GPIO 0-31 output register1_W1TC_REG	0x3FF44018	RO
GPIO_OUT_W1TS_REG	GPIO 0-31 output bit set register_REG	0x3FF44008	RO
GPIO_OUT_W1TC_REG	GPIO 0-31 output bit clear register_REG	0x3FF4400C	RO
GPIO_OUT1_REG	GPIO 32-39 output register_REG	0x3FF44010	R/W
GPIO_OUT1_W1TS_REG	GPIO 32-39 output register_W1TS_REG	0x3FF44014	RO
GPIO_OUT1_W1TC_REG	GPIO 32-39 output register_W1TC_REG	0x3FF44018	RO
GPIO_OUT1_W1TS_REG	GPIO 32-39 output bit set register_REG	0x3FF44014	RO
GPIO_OUT1_W1TC_REG	GPIO 32-39 output bit clear register_REG	0x3FF44018	RO
GPIO_ENABLE_REG	GPIO 0-31 output enable register_REG	0x3FF44020	R/W
GPIO_ENABLE_W1TS_REG	GPIO 0-31 output enable register_W1TS_REG	0x3FF44024	RO
GPIO_ENABLE_W1TC_REG	GPIO 0-31 output enable register_W1TC_REG	0x3FF44028	RO
GPIO_ENABLE1_REG	GPIO 0-31 output enable register1_REG	0x3FF4402C	R/W
GPIO_ENABLE1_W1TS_REG	GPIO 0-31 output enable register1_W1TS_REG	0x3FF44030	RO
GPIO_ENABLE1_W1TC_REG	GPIO 0-31 output enable register1_W1TC_REG	0x3FF44034	RO
GPIO_ENABLE_W1TS_REG	GPIO 0-31 output enable bit set register_REG	0x3FF44024	RO
GPIO_ENABLE_W1TC_REG	GPIO 0-31 output enable bit clear register_REG	0x3FF44028	RO
GPIO_ENABLE1_REG	GPIO 32-39 output enable register_REG	0x3FF4402C	R/W

Name	Description	Address	Access
GPIO_ENABLE1_W1TS_REG	GPIO 32-39 output enable register_W1TS_REG	0x3FF44030	RO
GPIO_ENABLE1_W1TC_REG	GPIO 32-39 output enable register_W1TC_REG	0x3FF44034	RO
GPIO_ENABLE1_W1TS_REG	GPIO 32-39 output enable bit set register_REG	0x3FF44030	RO
GPIO_ENABLE1_W1TC_REG	GPIO 32-39 output enable bit clear register_REG	0x3FF44034	RO
GPIO_STRAP_REG	Bootstrap pin value register_REG	0x3FF44038	RO
GPIO_IN_REG	GPIO 0-31 input register_REG	0x3FF4403C	RO
GPIO_IN1_REG	GPIO 0-31 input register1_REG	0x3FF44040	RO
GPIO_IN1_REG	GPIO 32-39 input register_REG	0x3FF44040	RO
GPIO_STATUS_REG	GPIO 0-31 interrupt status register_REG	0x3FF44044	R/W
GPIO_STATUS_W1TS_REG	GPIO 0-31 interrupt status register_W1TS_REG	0x3FF44048	RO
GPIO_STATUS_W1TC_REG	GPIO 0-31 interrupt status register_W1TC_REG	0x3FF4404C	RO
GPIO_STATUS1_REG	GPIO 0-31 interrupt status register1_REG	0x3FF44050	R/W
GPIO_STATUS1_W1TS_REG	GPIO 0-31 interrupt status register1_W1TS_REG	0x3FF44054	RO
GPIO_STATUS1_W1TC_REG	GPIO 0-31 interrupt status register1_W1TC_REG	0x3FF44058	RO
GPIO_STATUS_W1TS_REG	GPIO 0-31 interrupt status bit set register_REG	0x3FF44048	RO
GPIO_STATUS_W1TC_REG	GPIO 0-31 interrupt status bit clear register_REG	0x3FF4404C	RO
GPIO_STATUS1_REG	GPIO 32-39 interrupt status register_REG	0x3FF44050	R/W
GPIO_STATUS1_W1TS_REG	GPIO 32-39 interrupt status register_W1TS_REG	0x3FF44054	RO
GPIO_STATUS1_W1TC_REG	GPIO 32-39 interrupt status register_W1TC_REG	0x3FF44058	RO
GPIO_STATUS1_W1TS_REG	GPIO 32-39 interrupt status bit set register_REG	0x3FF44054	RO
GPIO_STATUS1_W1TC_REG	GPIO 32-39 interrupt status bit clear register_REG	0x3FF44058	RO
GPIO_ACPU_INT_REG	GPIO 0-31 APP_CPU interrupt status_REG	0x3FF44060	RO
GPIO_ACPU_INT1_REG	GPIO 0-31 APP_CPU interrupt status1_REG	0x3FF44074	RO
GPIO_ACPU_NMI_INT_REG	GPIO 0-31 APP_CPU non-maskable interrupt status_REG	0x3FF44064	RO
GPIO_ACPU_NMI_INT1_REG	GPIO 0-31 APP_CPU non-maskable interrupt status1_REG	0x3FF44078	RO
GPIO_PCPU_INT_REG	GPIO 0-31 PRO_CPU interrupt status_REG	0x3FF44068	RO
GPIO_PCPU_INT1_REG	GPIO 0-31 PRO_CPU interrupt status1_REG	0x3FF4407C	RO
GPIO_PCPU_NMI_INT_REG	GPIO 0-31 PRO_CPU non-maskable interrupt status_REG	0x3FF4406C	RO
GPIO_PCPU_NMI_INT1_REG	GPIO 0-31 PRO_CPU non-maskable interrupt status1_REG	0x3FF44080	RO
GPIO_ACPU_INT1_REG	GPIO 32-39 APP_CPU interrupt status_REG	0x3FF44074	RO
GPIO_ACPU_NMI_INT1_REG	GPIO 32-39 APP_CPU non-maskable interrupt status_REG	0x3FF44078	RO
GPIO_PCPU_INT1_REG	GPIO 32-39 PRO_CPU interrupt status_REG	0x3FF4407C	RO
GPIO_PCPU_NMI_INT1_REG	GPIO 32-39 PRO_CPU non-maskable interrupt status_REG	0x3FF44080	RO
GPIO_PIN0_REG	Configuration for GPIO pin 0_REG	0x3FF44088	R/W
GPIO_PIN1_REG	Configuration for GPIO pin 1_REG	0x3FF4408C	R/W
GPIO_PIN2_REG	Configuration for GPIO pin 2_REG	0x3FF44090	R/W
...	...		
GPIO_PIN38_REG	Configuration for GPIO pin 38_REG	0x3FF44120	R/W

Name	Description	Address	Access
GPIO_PIN39_REG	Configuration for GPIO pin 39_REG	0x3FF44124	R/W
GPIO_FUNC0_IN_SEL_CFG_REG	Peripheral function 0 input selection register_REG	0x3FF44130	R/W
GPIO_FUNC1_IN_SEL_CFG_REG	Peripheral function 1 input selection register_REG	0x3FF44134	R/W
...	...		
GPIO_FUNC254_IN_SEL_CFG_REG	Peripheral function 254 input selection register_REG	0x3FF44528	R/W
GPIO_FUNC255_IN_SEL_CFG_REG	Peripheral function 255 input selection register_REG	0x3FF4452C	R/W
GPIO_FUNC0_OUT_SEL_CFG_REG	Peripheral output selection for GPIO 0_REG	0x3FF44530	R/W
GPIO_FUNC1_OUT_SEL_CFG_REG	Peripheral output selection for GPIO 1_REG	0x3FF44534	R/W
...	...		
GPIO_FUNC38_OUT_SEL_CFG_REG	Peripheral output selection for GPIO 38_REG	0x3FF445C8	R/W
GPIO_FUNC39_OUT_SEL_CFG_REG	Peripheral output selection for GPIO 39_REG	0x3FF445CC	R/W

Name	Description	Address	Access
IO_MUX_GPIO36_REG	Configuration register for pad GPIO36	0x3FF53004	R/W
IO_MUX_GPIO37_REG	Configuration register for pad GPIO37	0x3FF53008	R/W
IO_MUX_GPIO38_REG	Configuration register for pad GPIO38	0x3FF5300C	R/W
IO_MUX_GPIO39_REG	Configuration register for pad GPIO39	0x3FF53010	R/W
IO_MUX_GPIO34_REG	Configuration register for pad GPIO34	0x3FF53014	R/W
IO_MUX_GPIO35_REG	Configuration register for pad GPIO35	0x3FF53018	R/W
IO_MUX_GPIO32_REG	Configuration register for pad GPIO32	0x3FF5301C	R/W
IO_MUX_GPIO33_REG	Configuration register for pad GPIO33	0x3FF53020	R/W
IO_MUX_GPIO25_REG	Configuration register for pad GPIO25	0x3FF53024	R/W
IO_MUX_GPIO26_REG	Configuration register for pad GPIO26	0x3FF53028	R/W
IO_MUX_GPIO27_REG	Configuration register for pad GPIO27	0x3FF5302C	R/W
IO_MUX_MTMS_REG	Configuration register for pad MTMS	0x3FF53030	R/W
IO_MUX_MTDI_REG	Configuration register for pad MTDI	0x3FF53034	R/W
IO_MUX_MTCK_REG	Configuration register for pad MTCK	0x3FF53038	R/W
IO_MUX_MTDO_REG	Configuration register for pad MTDO	0x3FF5303C	R/W
IO_MUX_GPIO2_REG	Configuration register for pad GPIO2	0x3FF53040	R/W
IO_MUX_GPIO0_REG	Configuration register for pad GPIO0	0x3FF53044	R/W
IO_MUX_GPIO4_REG	Configuration register for pad GPIO4	0x3FF53048	R/W
IO_MUX_GPIO16_REG	Configuration register for pad GPIO16	0x3FF5304C	R/W
IO_MUX_GPIO17_REG	Configuration register for pad GPIO17	0x3FF53050	R/W
IO_MUX_SD_DATA2_REG	Configuration register for pad SD_DATA2	0x3FF53054	R/W
IO_MUX_SD_DATA3_REG	Configuration register for pad SD_DATA3	0x3FF53058	R/W
IO_MUX_SD_CMD_REG	Configuration register for pad SD_CMD	0x3FF5305C	R/W
IO_MUX_SD_CLK_REG	Configuration register for pad SD_CLK	0x3FF53060	R/W
IO_MUX_SD_DATA0_REG	Configuration register for pad SD_DATA0	0x3FF53064	R/W
IO_MUX_SD_DATA1_REG	Configuration register for pad SD_DATA1	0x3FF53068	R/W
IO_MUX_GPIO5_REG	Configuration register for pad GPIO5	0x3FF5306C	R/W
IO_MUX_GPIO18_REG	Configuration register for pad GPIO18	0x3FF53070	R/W
IO_MUX_GPIO19_REG	Configuration register for pad GPIO19	0x3FF53074	R/W

Name	Description	Address	Access
IO_MUX_GPIO20_REG	Configuration register for pad GPIO20	0x3FF53078	R/W
IO_MUX_GPIO21_REG	Configuration register for pad GPIO21	0x3FF5307C	R/W
IO_MUX_GPIO22_REG	Configuration register for pad GPIO22	0x3FF53080	R/W
IO_MUX_U0RXD_REG	Configuration register for pad U0RXD	0x3FF53084	R/W
IO_MUX_U0TXD_REG	Configuration register for pad U0TXD	0x3FF53088	R/W
IO_MUX_GPIO23_REG	Configuration register for pad GPIO23	0x3FF5308C	R/W
IO_MUX_GPIO24_REG	Configuration register for pad GPIO24	0x3FF53090	R/W

Name	Description	Address	Access
GPIO configuration / data registers			
RTCIO_RTC_GPIO_OUT_REG	RTC GPIO output register_REG	0x3FF48000	R/W
RTCIO_RTC_GPIO_OUT_W1TS_REG	RTC GPIO output register_W1TS_REG	0x3FF48001	WO
RTCIO_RTC_GPIO_OUT_W1TC_REG	RTC GPIO output register_W1TC_REG	0x3FF48002	WO
RTCIO_RTC_GPIO_OUT_W1TS_REG	RTC GPIO output bit set register_REG	0x3FF48001	WO
RTCIO_RTC_GPIO_OUT_W1TC_REG	RTC GPIO output bit clear register_REG	0x3FF48002	WO
RTCIO_RTC_GPIO_ENABLE_REG	RTC GPIO output enable register_REG	0x3FF48003	R/W
RTCIO_RTC_GPIO_ENABLE_W1TS_REG	RTC GPIO output enable register_W1TS_REG	0x3FF48004	WO
RTCIO_RTC_GPIO_ENABLE_W1TC_REG	RTC GPIO output enable register_W1TC_REG	0x3FF48005	WO
RTCIO_RTC_GPIO_ENABLE_W1TS_REG	RTC GPIO output enable bit set register_REG	0x3FF48004	WO
RTCIO_RTC_GPIO_ENABLE_W1TC_REG	RTC GPIO output enable bit clear register_REG	0x3FF48005	WO
RTCIO_RTC_GPIO_STATUS_REG	RTC GPIO interrupt status register_REG	0x3FF48006	R/W
RTCIO_RTC_GPIO_STATUS_W1TS_REG	RTC GPIO interrupt status register_W1TS_REG	0x3FF48007	WO
RTCIO_RTC_GPIO_STATUS_W1TC_REG	RTC GPIO interrupt status register_W1TC_REG	0x3FF48008	WO
RTCIO_RTC_GPIO_STATUS_W1TS_REG	RTC GPIO interrupt status bit set register_REG	0x3FF48007	WO
RTCIO_RTC_GPIO_STATUS_W1TC_REG	RTC GPIO interrupt status bit clear register_REG	0x3FF48008	WO
RTCIO_RTC_GPIO_IN_REG	RTC GPIO input register_REG	0x3FF48009	RO
RTCIO_RTC_GPIO_PIN0_REG	RTC configuration for pin 0_REG	0x3FF4800A	R/W
RTCIO_RTC_GPIO_PIN1_REG	RTC configuration for pin 1_REG	0x3FF4800B	R/W
RTCIO_RTC_GPIO_PIN2_REG	RTC configuration for pin 2_REG	0x3FF4800C	R/W
RTCIO_RTC_GPIO_PIN3_REG	RTC configuration for pin 3_REG	0x3FF4800D	R/W
RTCIO_RTC_GPIO_PIN4_REG	RTC configuration for pin 4_REG	0x3FF4800E	R/W
RTCIO_RTC_GPIO_PIN5_REG	RTC configuration for pin 5_REG	0x3FF4800F	R/W
RTCIO_RTC_GPIO_PIN6_REG	RTC configuration for pin 6_REG	0x3FF48010	R/W
RTCIO_RTC_GPIO_PIN7_REG	RTC configuration for pin 7_REG	0x3FF48011	R/W
RTCIO_RTC_GPIO_PIN8_REG	RTC configuration for pin 8_REG	0x3FF48012	R/W
RTCIO_RTC_GPIO_PIN9_REG	RTC configuration for pin 9_REG	0x3FF48013	R/W
RTCIO_RTC_GPIO_PIN10_REG	RTC configuration for pin 10_REG	0x3FF48014	R/W
RTCIO_RTC_GPIO_PIN11_REG	RTC configuration for pin 11_REG	0x3FF48015	R/W
RTCIO_RTC_GPIO_PIN12_REG	RTC configuration for pin 12_REG	0x3FF48016	R/W
RTCIO_RTC_GPIO_PIN13_REG	RTC configuration for pin 13_REG	0x3FF48017	R/W
RTCIO_RTC_GPIO_PIN14_REG	RTC configuration for pin 14_REG	0x3FF48018	R/W

Name	Description	Address	Access
RTCIO_RTC_GPIO_PIN15_REG	RTC configuration for pin 15_REG	0x3FF48019	R/W
RTCIO_RTC_GPIO_PIN16_REG	RTC configuration for pin 16_REG	0x3FF4801A	R/W
RTCIO_RTC_GPIO_PIN17_REG	RTC configuration for pin 17_REG	0x3FF4801B	R/W
RTCIO_DIG_PAD_HOLD_REG	RTC GPIO hold register_REG	0x3FF4801D	R/W
GPIO RTC functions configuration registers			
RTCIO_HALL_SENS_REG	Hall sensor configuration_REG	0x3FF4801E	R/W
RTCIO_SENSOR_PADS_REG	Sensor pads configuration register_REG	0x3FF4801F	R/W
RTCIO_ADC_PAD_REG	ADC configuration register_REG	0x3FF48020	R/W
RTCIO_PAD_DAC1_REG	DAC1 configuration register_REG	0x3FF48021	R/W
RTCIO_PAD_DAC2_REG	DAC2 configuration register_REG	0x3FF48022	R/W
RTCIO_XTAL_32K_PAD_REG	32KHz crystal pads configuration register_REG	0x3FF48023	R/W
RTCIO_TOUCH_CFG_REG	Touch sensor configuration register_REG	0x3FF48024	R/W
RTCIO_EXT_WAKEUP0_REG	External wake up configuration register_REG	0x3FF4802F	R/W
RTCIO_XTL_EXT_CTR_REG	Crystal power down enable gpio source_REG	0x3FF48030	R/W
RTCIO_SAR_I2C_IO_REG	RTC I2C pad selection_REG	0x3FF48031	R/W

4.13 Registers

Register 4.1: GPIO_OUT_REG (0x0004)

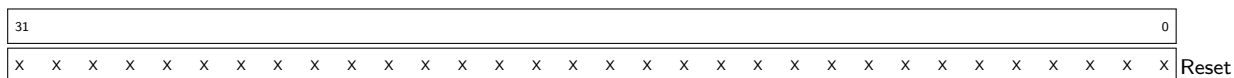

GPIO_OUT_REG GPIO0-31 output value. (R/W)

Register 4.2: GPIO_OUT_W1TS_REG (0x0008)

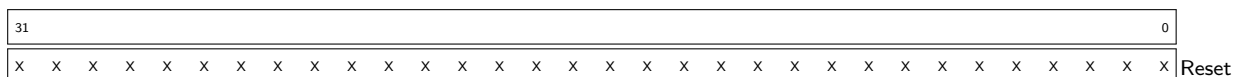

GPIO_OUT_W1TS_REG GPIO0-31 output set register. For every bit that is one in the value that is written here, the corresponding bit in GPIO_OUT_DATA will be set. (RO)

Register 4.3: GPIO_OUT_W1TC_REG (0x000c)

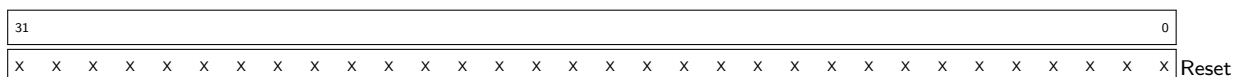

GPIO_OUT_W1TC_REG GPIO0-31 output clear register. For every bit that is one in the value that is written here, the corresponding bit in GPIO_OUT_DATA will be cleared. (RO)

Register 4.4: GPIO_OUT1_REG (0x0010)

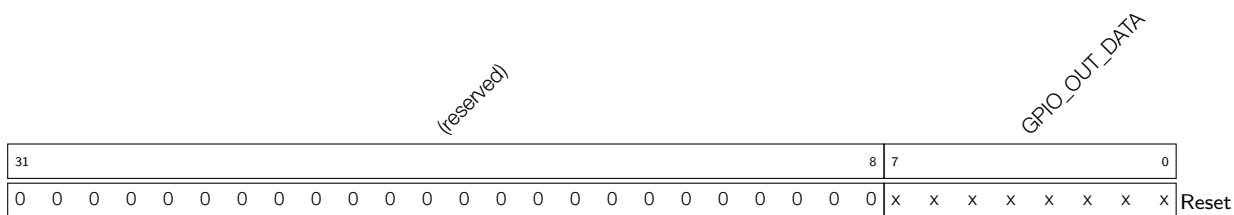

GPIO_OUT_DATA GPIO32-39 output value. (R/W)

Register 4.10: GPIO_ENABLE1_REG (0x002c)

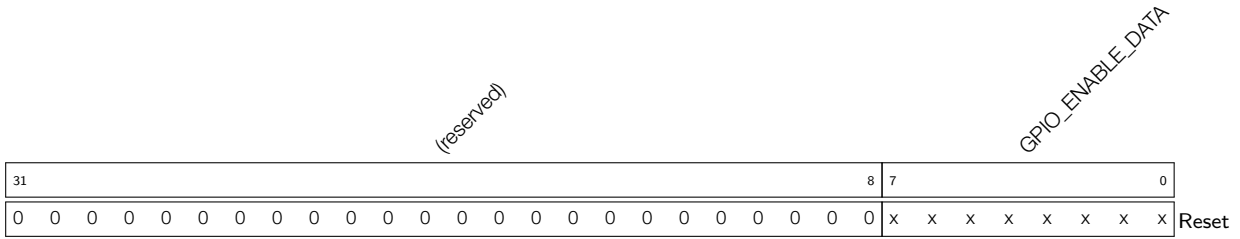

GPIO_ENABLE_DATA GPIO32-39 output enable. (R/W)

Register 4.11: GPIO_ENABLE1_W1TS_REG (0x0030)

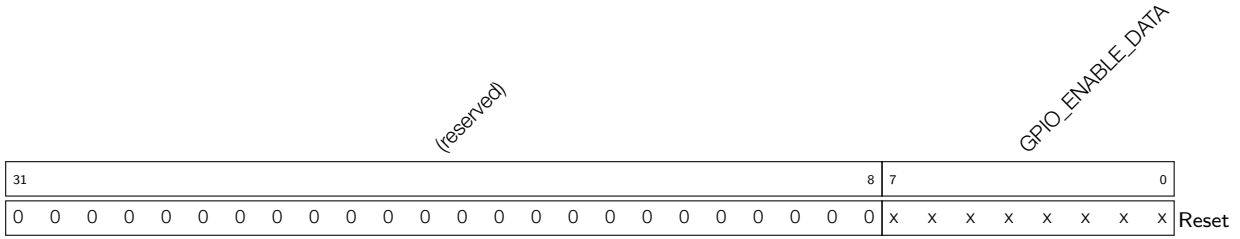

GPIO_ENABLE_DATA GPIO32-39 output enable set register. For every bit that is one in the value that is written here, the corresponding bit in GPIO_ENABLE1 will be set. (RO)

Register 4.12: GPIO_ENABLE1_W1TC_REG (0x0034)

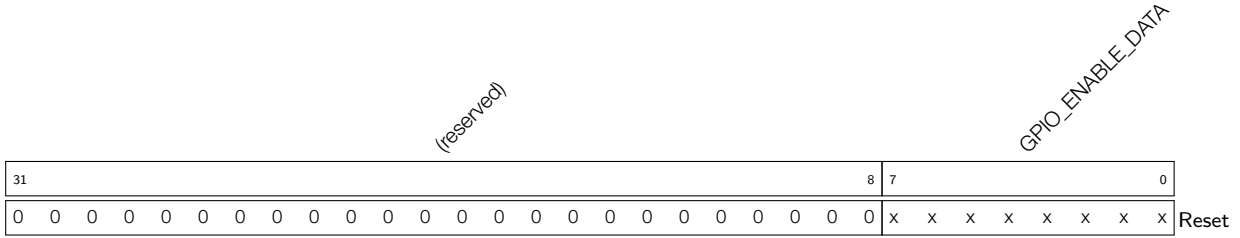

GPIO_ENABLE_DATA GPIO32-39 output enable clear register. For every bit that is one in the value that is written here, the corresponding bit in GPIO_ENABLE1 will be cleared. (RO)

Register 4.13: GPIO_STRAP_REG (0x0038)

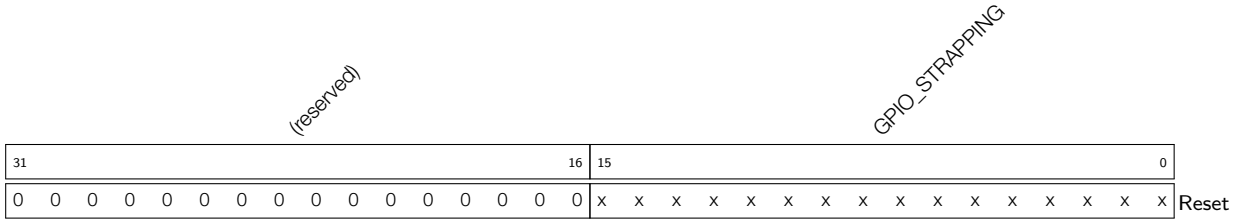

GPIO_STRAPPING GPIO strapping results: boot_sel_chip[5:0]: MTDI, GPIO0, GPIO2, GPIO4, MTDO, GPIO5.

Register 4.14: GPIO_IN_REG (0x003c)

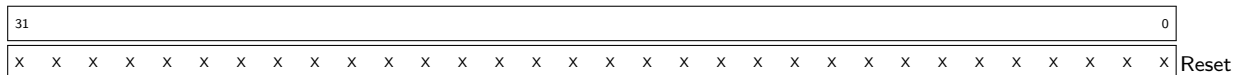

GPIO_IN_REG GPIO0-31 input value. Each bit represents pad input value, 1 for high level and 0 for low level. (RO)

Register 4.15: GPIO_IN1_REG (0x0040)

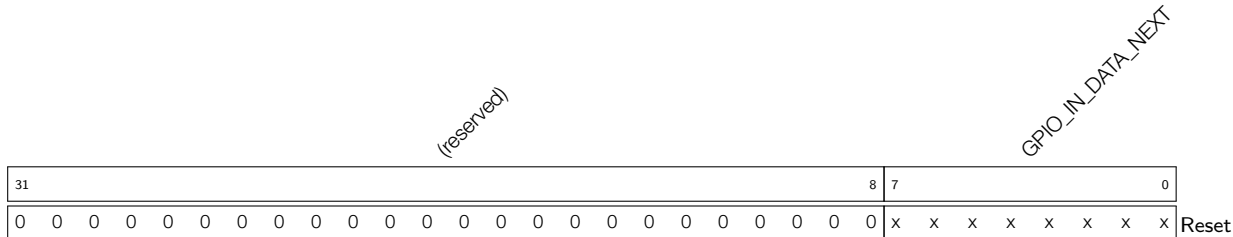

GPIO_IN_DATA_NEXT GPIO32-39 input value. Each bit represents pad input value. (RO)

Register 4.16: GPIO_STATUS_REG (0x0044)

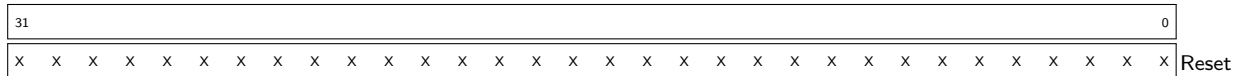

GPIO_STATUS_REG GPIO0-31 interrupt status register. Each bit can be the two interrupt sources for the two CPUs. The enable bits in GPIO_STATUS_INTERRUPT corresponding to the 0-4 bits in GPIO_PIN n _REG should be set to 1. (R/W)

Register 4.17: GPIO_STATUS_W1TS_REG (0x0048)

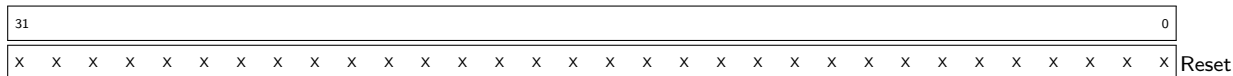

GPIO_STATUS_W1TS_REG GPIO0-31 interrupt status set register. For every bit that is one in the value that is written here, the corresponding bit in GPIO_STATUS_INTERRUPT will be set. (RO)

Register 4.18: GPIO_STATUS_W1TC_REG (0x004c)

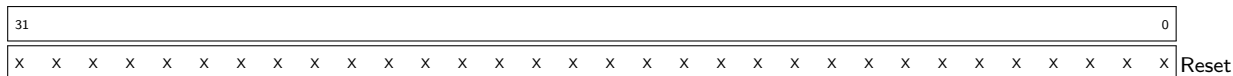

GPIO_STATUS_W1TC_REG GPIO0-31 interrupt status clear register. For every bit that is one in the value that is written here, the corresponding bit in GPIO_STATUS_INTERRUPT will be cleared. (RO)

Register 4.19: GPIO_STATUS1_REG (0x0050)

31	(reserved)	8	7	0	GPIO_STATUS_INTERRUPT Reset
0 0				x x x x x x x x	

GPIO_STATUS_INTERRUPT GPIO32-39 interrupt status. (R/W)

Register 4.20: GPIO_STATUS1_W1TS_REG (0x0054)

31	(reserved)	8	7	0	GPIO_STATUS_INTERRUPT Reset
0 0				x x x x x x x x	

GPIO_STATUS_INTERRUPT GPIO32-39 interrupt status set register. For every bit that is one in the value that is written here, the corresponding bit in GPIO_STATUS_INTERRUPT1 will be set. (RO)

Register 4.21: GPIO_STATUS1_W1TC_REG (0x0058)

31	(reserved)	8	7	0	GPIO_STATUS_INTERRUPT Reset
0 0				x x x x x x x x	

GPIO_STATUS_INTERRUPT GPIO32-39 interrupt status clear register. For every bit that is one in the value that is written here, the corresponding bit in GPIO_STATUS_INTERRUPT1 will be cleared. (RO)

Register 4.22: GPIO_ACPU_INT_REG (0x0060)

31	(reserved)	8	7	0	GPIO_STATUS_INTERRUPT Reset
x x					

GPIO_ACPU_INT_REG GPIO0-31 APP CPU interrupt status. (RO)

Register 4.23: GPIO_ACPU_NMI_INT_REG (0x0064)

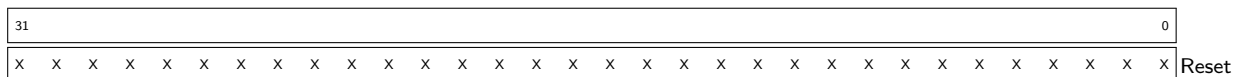

GPIO_ACPU_NMI_INT_REG GPIO0-31 APP CPU non-maskable interrupt status. (RO)

Register 4.24: GPIO_PCPU_INT_REG (0x0068)

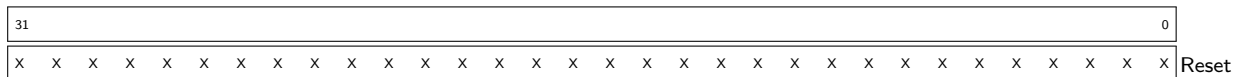

GPIO_PCPU_INT_REG GPIO0-31 PRO CPU interrupt status. (RO)

Register 4.25: GPIO_PCPU_NMI_INT_REG (0x006c)

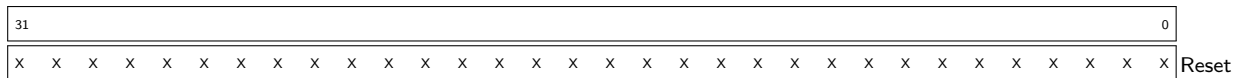

GPIO_PCPU_NMI_INT_REG GPIO0-31 PRO CPU non-maskable interrupt status. (RO)

Register 4.26: GPIO_ACPU_INT1_REG (0x0074)

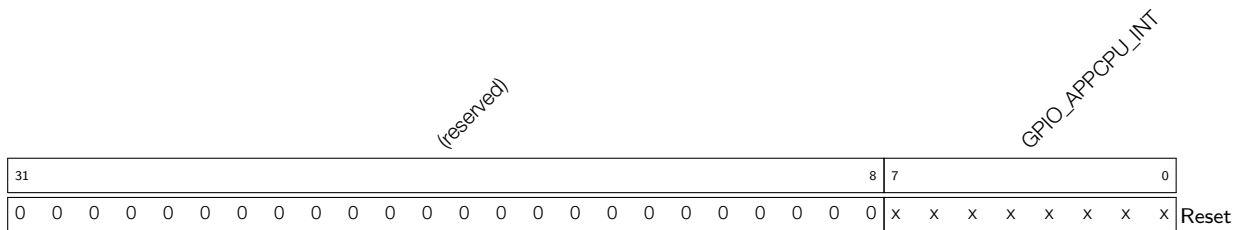

GPIO_APPCPU_INT GPIO32-39 APP CPU interrupt status. (RO)

Register 4.27: GPIO_ACPU_NMI_INT1_REG (0x0078)

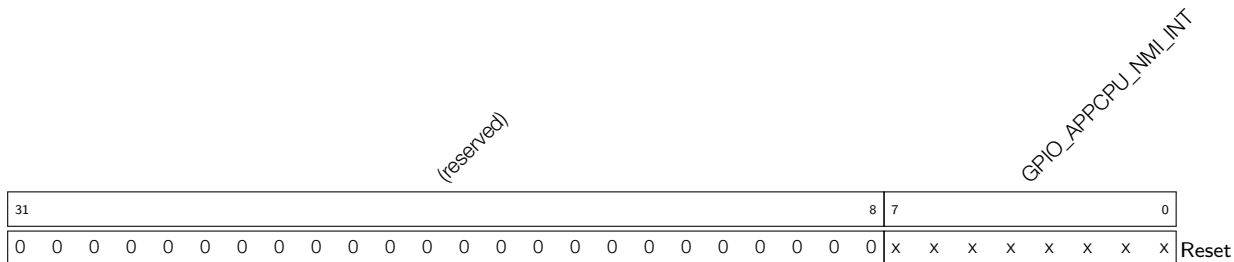

GPIO_APPCPU_NMI_INT GPIO32-39 APP CPU non-maskable interrupt status. (RO)

Register 4.28: GPIO_PCPU_INT1_REG (0x007c)

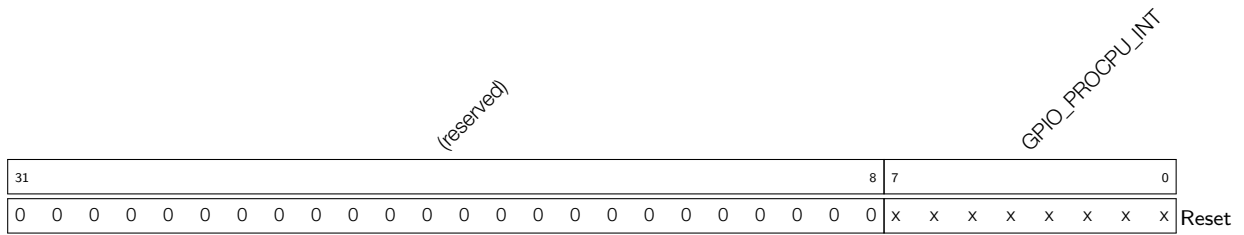

GPIO_PROCPU_INT GPIO32-39 PRO CPU interrupt status. (RO)

Register 4.29: GPIO_PCPU_NMI_INT1_REG (0x0080)

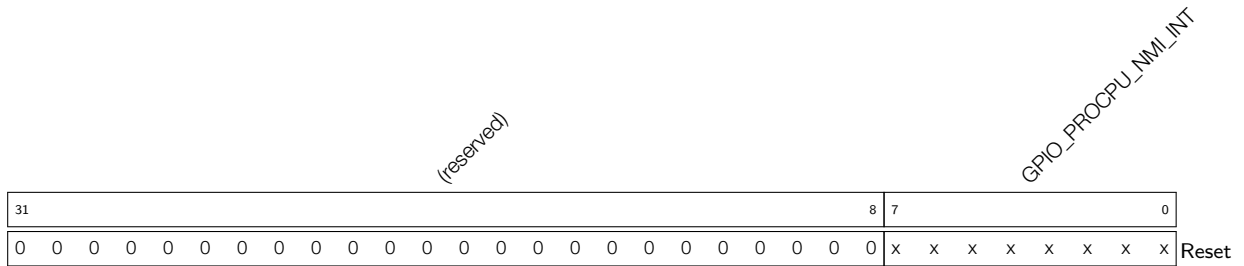

GPIO_PROCPU_NMI_INT GPIO32-39 PRO CPU non-maskable interrupt status. (RO)

Register 4.30: GPIO_PIN n _REG (n : 0-39) (0x88+0x4* n)

(reserved)											GPIO_PIN n _INT_ENA				(reserved)				GPIO_PIN n _WAKEUP_ENABLE				GPIO_PIN n _INT_TYPE				(reserved)				GPIO_PIN n _PAD_DRIVER				(reserved)				
31																		18	17					13	12	11	10	9			7	6				3	2	3	2
0	0	0	0	0	0	0	0	0	0	0	0	0	0	0	0	0	x	x	x	x	x	0	0	x	x	x	x	0	0	0	0	x	0	0					

Reset

GPIO_PIN n _INT_ENA Interrupt enable bits for pin n : (R/W)

- bit0: APP CPU interrupt enable;
- bit1: APP CPU non-maskable interrupt enable;
- bit3: PRO CPU interrupt enable;
- bit4: PRO CPU non-maskable interrupt enable.

GPIO_PIN n _WAKEUP_ENABLE GPIO wake up enable. Will only wake the CPU from Light-sleep. (R/W)

GPIO_PIN n _INT_TYPE Interrupt type selection: (R/W)

- 0: GPIO interrupt disable;
- 1: rising edge trigger;
- 2: falling edge trigger;
- 3: any edge trigger;
- 4: low level trigger;
- 5: high level trigger.

GPIO_PIN n _PAD_DRIVER 0: normal output; 1: open drain output. (R/W)

Register 4.31: GPIO_FUNC m _IN_SEL_CFG_REG (m : 0-255) (0x130+0x4* m)

(reserved)																	GPIO_SIG m _IN_SEL				GPIO_FUNC m _IN_INV_SEL				GPIO_FUNC m _IN_SEL															
31																		8	7	6	5													0						
0	0	0	0	0	0	0	0	0	0	0	0	0	0	0	0	0	0	0	0	0	0	0	0	0	0	0	0	0	0	0	0	0	x	x	x	x	x	x	x	x

Reset

GPIO_SIG m _IN_SEL Bypass the GPIO Matrix. 0: route through GPIO Matrix, 1: connect signal directly to peripheral configured in the IO_MUX. (R/W)

GPIO_FUNC m _IN_INV_SEL Invert the input value. 1: invert; 0: do not invert. (R/W)

GPIO_FUNC m _IN_SEL Selection control for peripheral input m . A value of 0-39 selects which of the 40 GPIO Matrix input pins this signal is connected to, or 0x38 for a constant high input or 0x30 for a constant low input. (R/W)

Register 4.32: GPIO_FUNC n _OUT_SEL_CFG_REG (n : 0-39) (0x530+0x4*n)

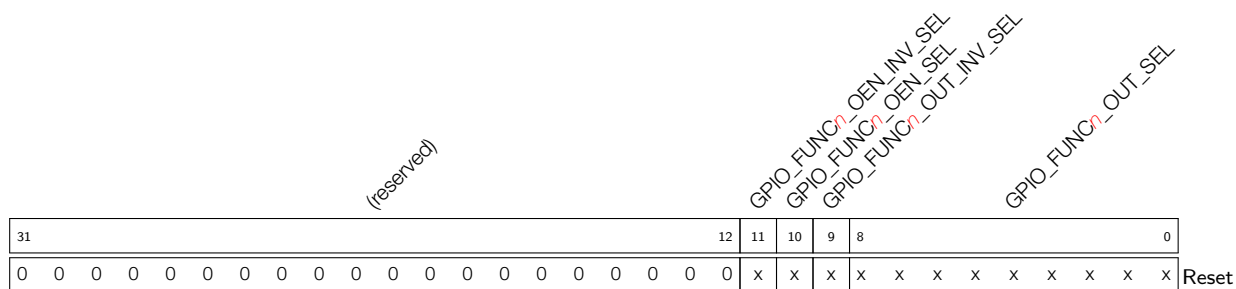

GPIO_FUNC n _OEN_INV_SEL 1: Invert the output enable signal; 0: do not invert the output enable signal. (R/W)

GPIO_FUNC n _OEN_SEL 1: Force the output enable signal to be sourced from bit n of GPIO_ENABLE_REG; 0: use output enable signal from peripheral. (R/W)

GPIO_FUNC n _OUT_INV_SEL 1: Invert the output value; 0: do not invert the output value. (R/W)

GPIO_FUNC n _OUT_SEL Selection control for GPIO output n . A value of s ($0 \leq s < 256$) connects peripheral output s to GPIO output n . A value of 256 selects bit n of GPIO_DATA_REG and GPIO_ENABLE_REG as the output value and output enable. (R/W)

Register 4.33: IO_MUX_X_REG (x: GPIO0-GPIO39) (0x10+4*x)

(reserved)															<i>IO_x_MCU_SEL</i>		<i>IO_x_FUNC_DRV</i>		<i>IO_x_FUNC_IE</i>		<i>IO_x_FUNC_WPU</i>		<i>IO_x_FUNC_WPD</i>		<i>IO_x_MCU_DRV</i>		<i>IO_x_MCU_IE</i>		<i>IO_x_MCU_WPU</i>		<i>IO_x_MCU_WPD</i>		<i>IO_x_SLP_SEL</i>		<i>IO_x_MCU_OE</i>	
31															15	14	12	11	10	9	8	7	6	5	4	3	2	1	0							
0															0x0		0x2		0		0		0x0		0		0		0		0		0		Reset	

- IO_x_MCU_SEL** Select the IO_MUX function for this signal. 0 selects Function 1, 1 selects Function 2, etc. (R/W)
- IO_x_FUNC_DRV** Select the drive strength of the pad. A higher value selects a higher strength. (R/W)
- IO_x_FUNC_IE** Input enable of the pad. 1: input enabled; 0: input disabled. (R/W)
- IO_x_FUNC_WPU** Pull-up enable of the pad. 1: internal pull-up enabled; 0: internal pull-up disabled. (R/W)
- IO_x_FUNC_WPD** Pull-down enable of the pad. 1: internal pull-down enabled, 0: internal pull-down disabled. (R/W)
- IO_x_MCU_DRV** Select the drive strength of the pad during sleep mode. A higher value selects a higher strength. (R/W)
- IO_x_MCU_IE** Input enable of the pad during sleep mode. 1: input enabled; 0: input disabled. (R/W)
- IO_x_MCU_WPU** Pull-up enable of the pad during sleep mode. 1: internal pull-up enabled; 0: internal pull-up disabled. (R/W)
- IO_x_MCU_WPD** Pull-down enable of the pad during sleep mode. 1: internal pull-down enabled; 0: internal pull-down disabled. (R/W)
- IO_x_SLP_SEL** Sleep mode selection of this pad. Set to 1 to put the pad in sleep mode. (R/W)
- IO_x_MCU_OE** Output enable of the pad in sleep mode. 1: enable output; 0: disable output. (R/W)

Register 4.34: RTCIO_RTC_GPIO_OUT_REG (0x0000)

<i>RTCIO_RTC_GPIO_OUT_DATA</i>															(reserved)																																																																																																	
31															14															27															14																																																																			
x															x														0														0														0														0														0														Reset													

RTCIO_RTC_GPIO_OUT_DATA GPIO0-17 output register. Bit14 is GPIO[0], bit15 is GPIO[1], etc. (R/W)

Register 4.35: RTCIO_RTC_GPIO_OUT_W1TS_REG (0x0001)

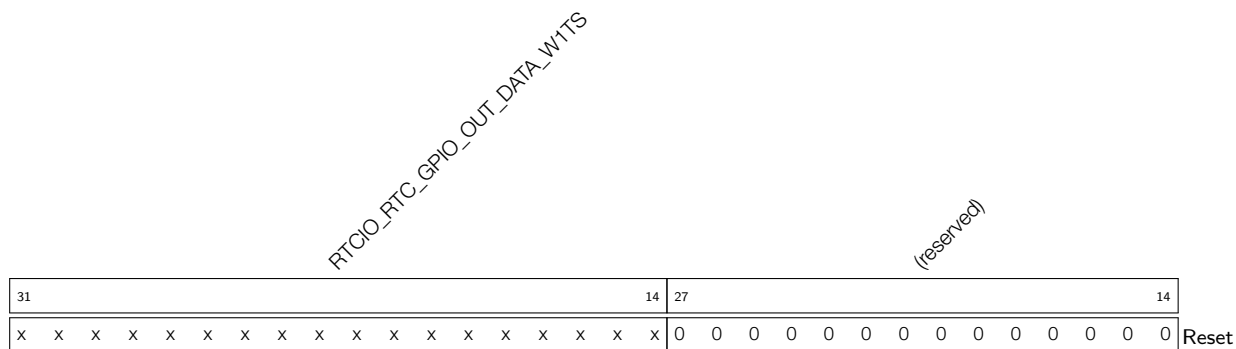

RTCIO_RTC_GPIO_OUT_DATA_W1TS GPIO0-17 output set register. For every bit that is one in the value that is written here, the corresponding bit in RTCIO_RTC_GPIO_OUT will be set. (WO)

Register 4.36: RTCIO_RTC_GPIO_OUT_W1TC_REG (0x0002)

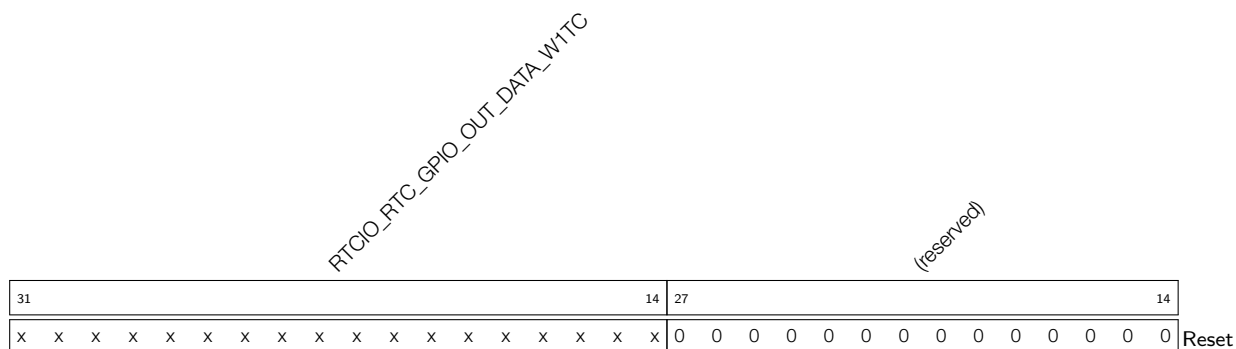

RTCIO_RTC_GPIO_OUT_DATA_W1TC GPIO0-17 output clear register. For every bit that is one in the value that is written here, the corresponding bit in RTCIO_RTC_GPIO_OUT will be cleared. (WO)

Register 4.37: RTCIO_RTC_GPIO_ENABLE_REG (0x0003)

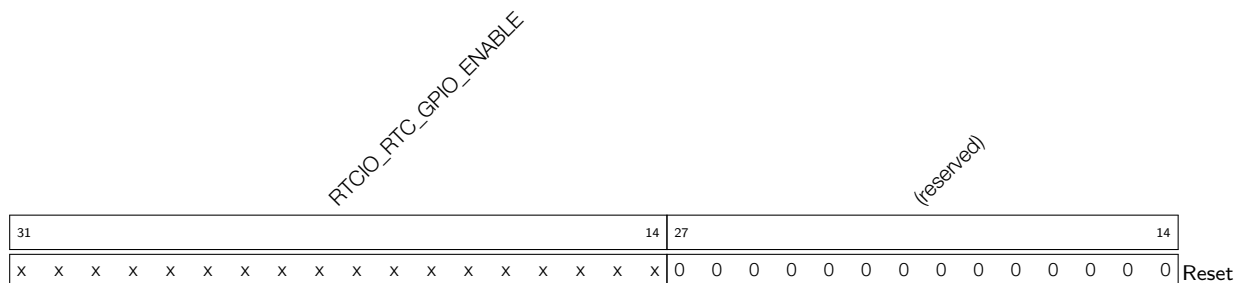

RTCIO_RTC_GPIO_ENABLE GPIO0-17 output enable. Bit14 is GPIO[0], bit15 is GPIO[1], etc. 1 means this GPIO pad is output. (R/W)

Register 4.38: RTCIO_RTC_GPIO_ENABLE_W1TS_REG (0x0004)

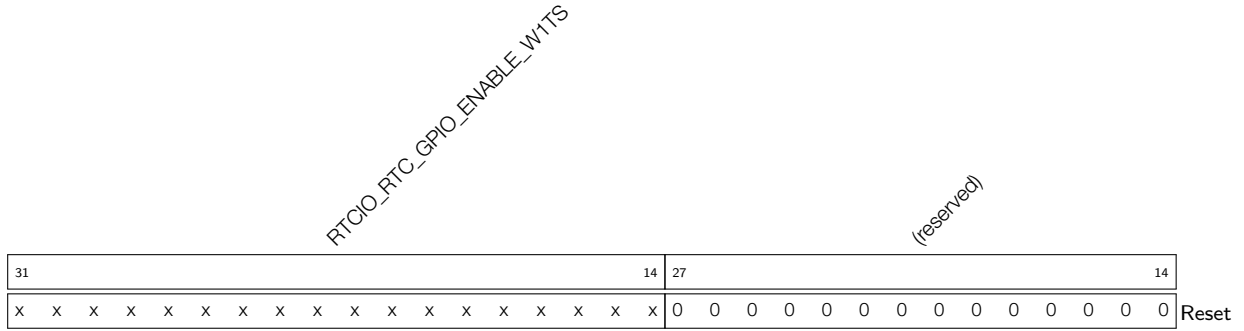

RTCIO_RTC_GPIO_ENABLE_W1TS GPIO0-17 output enable set register. For every bit that is one in the value that is written here, the corresponding bit in RTCIO_RTC_GPIO_ENABLE will be set. (WO)

Register 4.39: RTCIO_RTC_GPIO_ENABLE_W1TC_REG (0x0005)

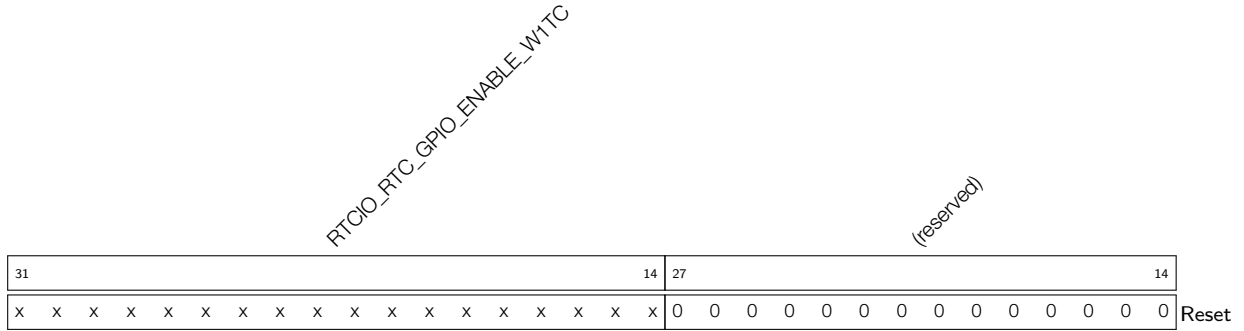

RTCIO_RTC_GPIO_ENABLE_W1TC GPIO0-17 output enable clear register. For every bit that is one in the value that is written here, the corresponding bit in RTCIO_RTC_GPIO_ENABLE will be cleared. (WO)

Register 4.40: RTCIO_RTC_GPIO_STATUS_REG (0x0006)

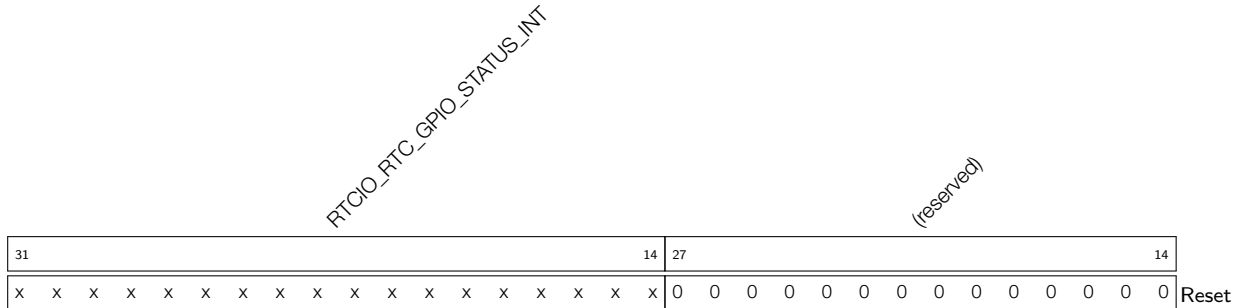

RTCIO_RTC_GPIO_STATUS_INT GPIO0-17 interrupt status. Bit14 is GPIO[0], bit15 is GPIO[1], etc. This register should be used together with RTCIO_RTC_GPIO_PIN_n_INT_TYPE in RTCIO_RTC_GPIO_PIN_n_REG. 1 means there is corresponding interrupt, 0 means there is no interrupt. (R/W)

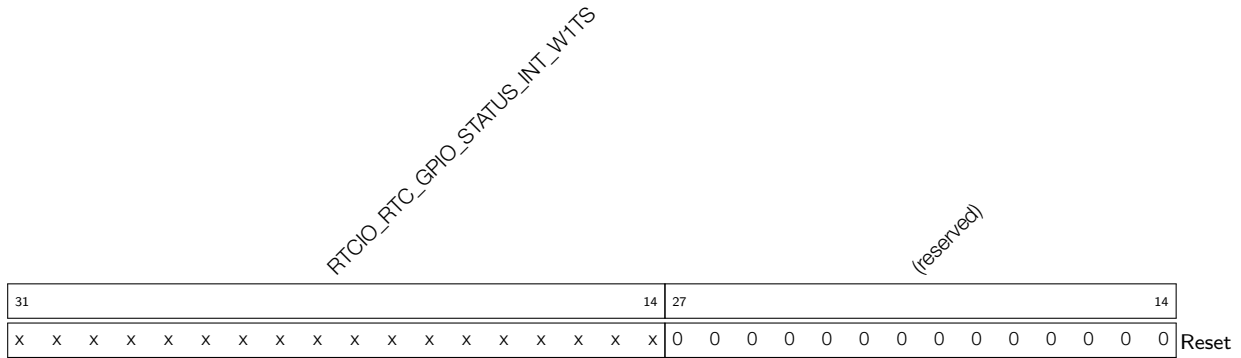
Register 4.41: RTCIO_RTC_GPIO_STATUS_W1TS_REG (0x0007)

RTCIO_RTC_GPIO_STATUS_INT_W1TS GPIO0-17 interrupt set register. For every bit that is one in the value that is written here, the corresponding bit in RTCIO_RTC_GPIO_STATUS_INT will be set. (WO)

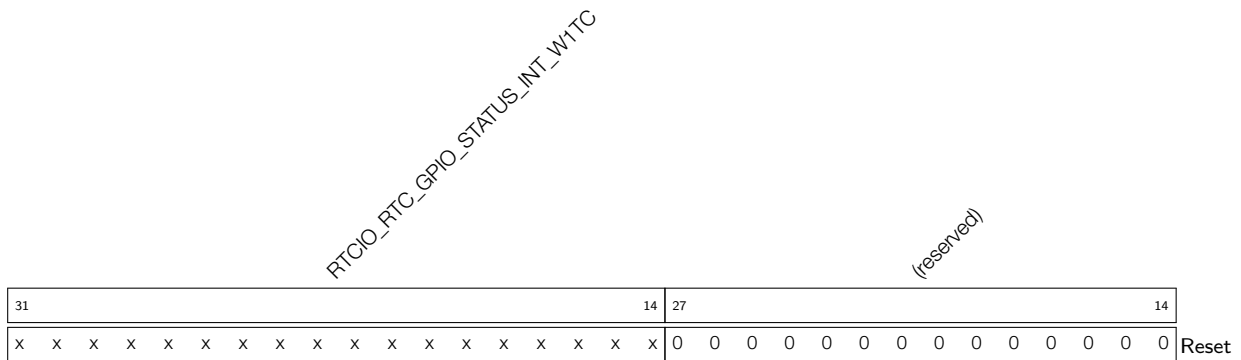
Register 4.42: RTCIO_RTC_GPIO_STATUS_W1TC_REG (0x0008)

RTCIO_RTC_GPIO_STATUS_INT_W1TC GPIO0-17 interrupt clear register. For every bit that is one in the value that is written here, the corresponding bit in RTCIO_RTC_GPIO_STATUS_INT will be cleared. (WO)

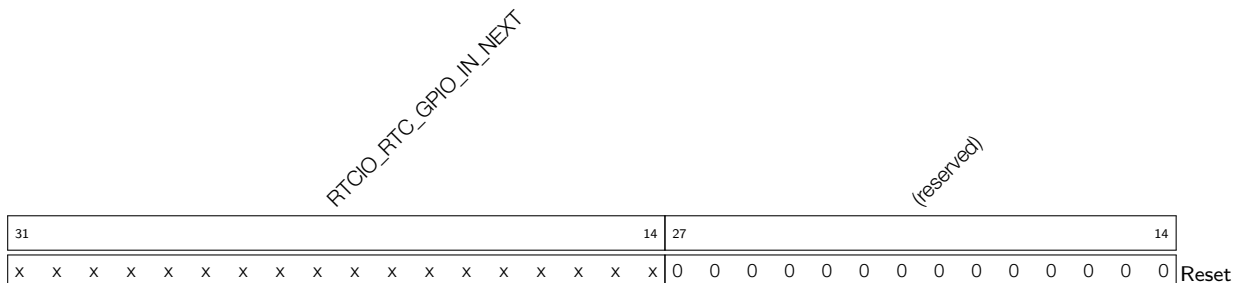
Register 4.43: RTCIO_RTC_GPIO_IN_REG (0x0009)

RTCIO_RTC_GPIO_IN_NEXT GPIO0-17 input value. Bit14 is GPIO[0], bit15 is GPIO[1], etc. Each bit represents pad input value, 1 for high level and 0 for low level. (RO)

Register 4.44: RTCIO_RTC_GPIO_PIN_n_REG (n: 0-17) (0xA+1*n)

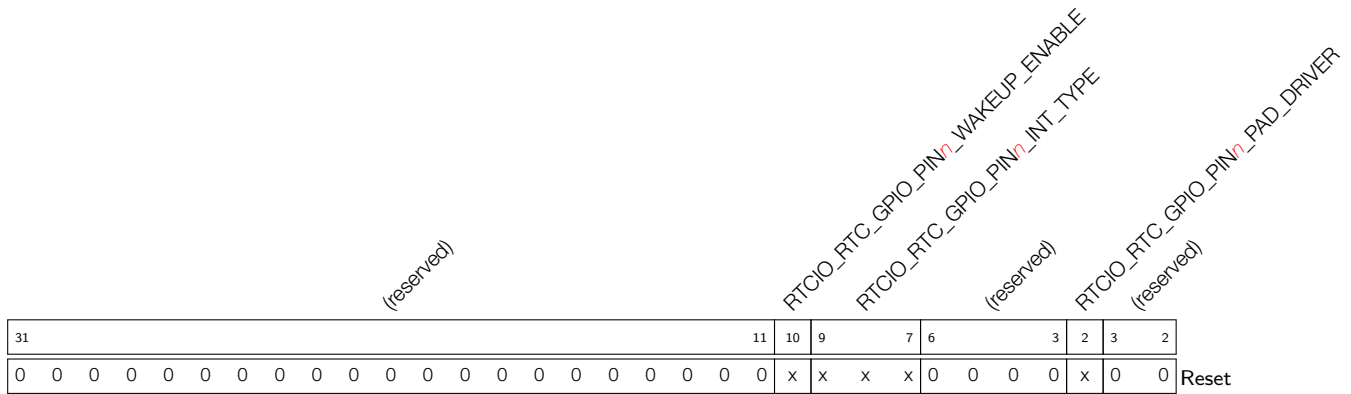

RTCIO_RTC_GPIO_PIN_n_WAKEUP_ENABLE GPIO wake up enable. This will only wake up the ESP32 from Light-sleep. (R/W)

RTCIO_RTC_GPIO_PIN_n_INT_TYPE GPIO interrupt type selection. (R/W)

- 0: GPIO interrupt disable;
- 1: rising edge trigger;
- 2: falling edge trigger;
- 3: any edge trigger;
- 4: low level trigger;
- 5: high level trigger.

RTCIO_RTC_GPIO_PIN_n_PAD_DRIVER Pad driver selection. 0: normal output; 1: open drain. (R/W)

Register 4.45: RTCIO_DIG_PAD_HOLD_REG (0x001d)

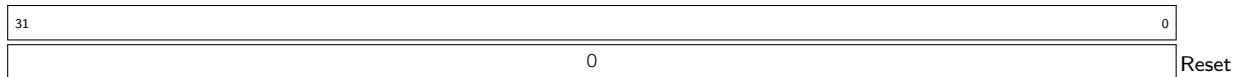

RTCIO_DIG_PAD_HOLD_REG Select which digital pads are on hold. 0 allows normal operation, 1 holds the pad. (R/W)

Register 4.46: RTCIO_HALL_SENS_REG (0x001e)

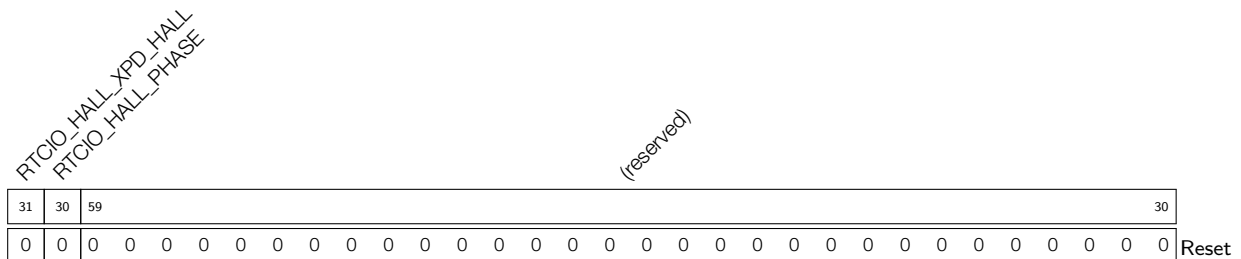

RTCIO_HALL_XPD_HALL Power on hall sensor and connect to VP and VN. (R/W)

RTCIO_HALL_PHASE Reverse the polarity of the hall sensor. (R/W)

Register 4.47: RTCIO_SENSOR_PADS_REG (0x001f)

(reserved)																														
31	30	29	28	27	26	25	24	23	22	21	20	19	18	17	16	15	14	13	12	11	10	9	8	7	6	5	4	7	4	
0	0	0	0	0	0	0	0	0	0	0	0	0	0	0	0	0	0	0	0	0	0	0	0	0	0	0	0	0	0	0

Reset

- RTCIO_SENSOR_SENSE n _HOLD** Set to 1 to hold the output value on sense n , 0 for normal operation. (R/W)
- RTCIO_SENSOR_SENSE n _MUX_SEL** 1: route sense n to the RTC block; 0: route sense n to the digital IO_MUX. (R/W)
- RTCIO_SENSOR_SENSE n _FUN_SEL** Select the RTC IO_MUX function for this pad. 0: select Function 0; 1: select Function 1. (R/W)
- RTCIO_SENSOR_SENSE n _SLP_SEL** Sleep mode selection signal of the pad. Set to 1 to put the pad in sleep mode. (R/W)
- RTCIO_SENSOR_SENSE n _SLP_IE** Input enable of the pad in sleep mode. 1: enabled; 0: disabled. (R/W)
- RTCIO_SENSOR_SENSE n _FUN_IE** Input enable of the pad. 1: enabled; 0: disabled. (R/W)

Register 4.48: RTCIO_ADC_PAD_REG (0x0020)

RTCIO_ADC_ADC1_HOLD												RTCIO_ADC_ADC2_HOLD												(reserved)											
RTCIO_ADC_ADC1_MUX_SEL												RTCIO_ADC_ADC2_MUX_SEL												(reserved)											
RTCIO_ADC_ADC1_FUN_SEL												RTCIO_ADC_ADC2_FUN_SEL												(reserved)											
RTCIO_ADC_ADC1_SLP_SEL												RTCIO_ADC_ADC2_SLP_SEL												(reserved)											
RTCIO_ADC_ADC1_SLP_IE												RTCIO_ADC_ADC2_SLP_IE												(reserved)											
RTCIO_ADC_ADC1_FUN_IE												RTCIO_ADC_ADC2_FUN_IE												(reserved)											
RTCIO_ADC_ADC2_HOLD												RTCIO_ADC_ADC1_HOLD												(reserved)											
RTCIO_ADC_ADC2_MUX_SEL												RTCIO_ADC_ADC1_MUX_SEL												(reserved)											
RTCIO_ADC_ADC2_FUN_SEL												RTCIO_ADC_ADC1_FUN_SEL												(reserved)											
RTCIO_ADC_ADC2_SLP_SEL												RTCIO_ADC_ADC1_SLP_SEL												(reserved)											
RTCIO_ADC_ADC2_SLP_IE												RTCIO_ADC_ADC1_SLP_IE												(reserved)											
RTCIO_ADC_ADC2_FUN_IE												RTCIO_ADC_ADC1_FUN_IE												(reserved)											
31	30	29	28	27	26	25	24	23	22	21	20	19	18	35	18	Reset																			
0	0	0	0	0	0	0	0	0	0	0	0	0	0	0	0	0																			

RTCIO_ADC_ADC n _HOLD Set to 1 to hold the output value on the pad, 0 for normal operation. (R/W)

RTCIO_ADC_ADC n _MUX_SEL 1: route pad to the digital IO_MUX; (R/W)
0: route pad to the RTC block.

RTCIO_ADC_ADC n _FUN_SEL Select the RTC function for this pad. 0: select Function 0; 1: select Function 1. (R/W)

RTCIO_ADC_ADC n _SLP_SEL Sleep mode selection signal of the pad. Set this bit to 1 to put the pad to sleep. (R/W)

RTCIO_ADC_ADC n _SLP_IE Input enable of the pad in sleep mode. 1: enabled; 0: disabled. (R/W)

RTCIO_ADC_ADC n _FUN_IE Input enable of the pad. 1: enabled; 0: disabled. (R/W)

Register 4.49: RTCIO_PAD_DAC1_REG (0x0021)

RTCIO_PAD_PDAC1_DRV				RTCIO_PAD_PDAC1_HOLD				RTCIO_PAD_PDAC1_RDE				RTCIO_PAD_PDAC1_RUE				RTCIO_PAD_PDAC1_DAC				RTCIO_PAD_PDAC1_XPD_DAC				RTCIO_PAD_PDAC1_MUX_SEL				RTCIO_PAD_PDAC1_FUN_SEL				RTCIO_PAD_PDAC1_SLP_SEL				RTCIO_PAD_PDAC1_SLP_IE				RTCIO_PAD_PDAC1_SLP_OE				RTCIO_PAD_PDAC1_FUN_IE				RTCIO_PAD_PDAC1_DAC_XPD_FORCE				(reserved)			
31	30	29	28	27	26											19	18	17	16	15	14	13	12	11	10	19											10																		
2	0	0	0	0										0	0	0	0	0	0	0	0	0	0	0	0	0	0	0	0	0	0	0	0	0	0	0	0	0	0	0	0	0	0	0	Reset										

- RTCIO_PAD_PDAC1_DRV** Select the drive strength of the pad. (R/W)
- RTCIO_PAD_PDAC1_HOLD** Set to 1 to hold the output value on the pad, 0 for normal operation. (R/W)
- RTCIO_PAD_PDAC1_RDE** 1: Pull-down on pad enabled; 0: Pull-down disabled. (R/W)
- RTCIO_PAD_PDAC1_RUE** 1: Pull-up on pad enabled; 0: Pull-up disabled. (R/W)
- RTCIO_PAD_PDAC1_DAC** PAD DAC1 output value. (R/W)
- RTCIO_PAD_PDAC1_XPD_DAC** Power on DAC1. Usually, PDAC1 needs to be tristated if we power on the DAC, i.e. IE=0, OE=0, RDE=0, RUE=0. (R/W)
- RTCIO_PAD_PDAC1_MUX_SEL** 1: route pad to the digital IO_MUX; (R/W)
0: route sense 4 to the RTC block.
- RTCIO_PAD_PDAC1_FUN_SEL** the functional selection signal of the pad. (R/W)
- RTCIO_PAD_PDAC1_SLP_SEL** Sleep mode selection signal of the pad. Set this bit to 1 to put the pad to sleep. (R/W)
- RTCIO_PAD_PDAC1_SLP_IE** Input enable of the pad in sleep mode. 1: enabled; 0: disabled. (R/W)
- RTCIO_PAD_PDAC1_SLP_OE** Output enable of the pad. 1: enabled; 0: disabled. (R/W)
- RTCIO_PAD_PDAC1_FUN_IE** Input enable of the pad. 1: enabled; 0: disabled. (R/W)
- RTCIO_PAD_PDAC1_DAC_XPD_FORCE** Power on DAC1. Usually, we need to tristate PDAC1 if we power on the DAC, i.e. IE=0, OE=0, RDE=0, RUE=0. (R/W)

Register 4.50: RTCIO_PAD_DAC2_REG (0x0022)

31	30	29	28	27	26								19	18	17	16	15	14	13	12	11	10	9	8	7	6	5	4	3	2	1	0	Reset				
RTCIO_PAD_PDAC2_DRV		RTCIO_PAD_PDAC2_HOLD		RTCIO_PAD_PDAC2_RDE		RTCIO_PAD_PDAC2_RUE		RTCIO_PAD_PDAC2_DAC							RTCIO_PAD_PDAC2_XPD_DAC		RTCIO_PAD_PDAC2_MUX_SEL		RTCIO_PAD_PDAC2_FUN_SEL		RTCIO_PAD_PDAC2_SLP_SEL		RTCIO_PAD_PDAC2_SLP_IE		RTCIO_PAD_PDAC2_SLP_OE		RTCIO_PAD_PDAC2_FUN_IE		RTCIO_PAD_PDAC2_DAC_XPD_FORCE		(reserved)						
2	0	0	0	0							0	0	0	0	0	0	0	0	0	0	0	0	0	0	0	0	0	0	0	0	0	0	0	0	0	0	0

- RTCIO_PAD_PDAC2_DRV** Select the drive strength of the pad. (R/W)
- RTCIO_PAD_PDAC2_HOLD** Set to 1 to hold the output value on the pad, 0 for normal operation. (R/W)
- RTCIO_PAD_PDAC2_RDE** 1: Pull-down on pad enabled; 0: Pull-down disabled. (R/W)
- RTCIO_PAD_PDAC2_RUE** 1: Pull-up on pad enabled; 0: Pull-up disabled. (R/W)
- RTCIO_PAD_PDAC2_DAC** PAD DAC2 output value. (R/W)
- RTCIO_PAD_PDAC2_XPD_DAC** Power on DAC2. PDAC2 needs to be tristated if we power on the DAC, i.e. IE=0, OE=0, RDE=0, RUE=0. (R/W)
- RTCIO_PAD_PDAC2_MUX_SEL** 1: route pad to the digital IO_MUX; (R/W)
0: route sense 4 to the RTC block.
- RTCIO_PAD_PDAC2_FUN_SEL** Select the RTC function for this pad. 0: select Function 0; 1: select Function 1. (R/W)
- RTCIO_PAD_PDAC2_SLP_SEL** Sleep mode selection signal of the pad. Set this bit to 1 to put the pad to sleep. (R/W)
- RTCIO_PAD_PDAC2_SLP_IE** Input enable of the pad in sleep mode. 1: enabled; 0: disabled. (R/W)
- RTCIO_PAD_PDAC2_SLP_OE** Output enable of the pad. 1: enabled; 0: disabled. (R/W)
- RTCIO_PAD_PDAC2_FUN_IE** Input enable of the pad. 1: enabled; 0: disabled. (R/W)
- RTCIO_PAD_PDAC2_DAC_XPD_FORCE** Power on DAC2. Usually, we need to tristate PDAC2 if we power on the DAC, i.e. IE=0, OE=0, RDE=0, RUE=0. (R/W)

Register 4.51: RTCIO_XTAL_32K_PAD_REG (0x0023)

31	30	29	28	27	26	25	24	23	22	21	20	19	18	17	16	15	14	13	12	11	10	9	8	7	6	5	4	3	2	1	1	
2	0	0	0	0	2	0	0	0	0	0	1	0	0	0	0	0	0	0	0	0	0	0	0	0	0	0	0	1	0	0	0	0

Reset

RTCIO_XTAL_X32N_DRV Select the drive strength of the pad. (R/W)

RTCIO_XTAL_X32N_HOLD Set to 1 to hold the output value on the pad, 0 for normal operation. (R/W)

RTCIO_XTAL_X32N_RDE 1: Pull-down on pad enabled; 0: Pull-down disabled. (R/W)

RTCIO_XTAL_X32N_RUE 1: Pull-up on pad enabled; 0: Pull-up disabled. (R/W)

RTCIO_XTAL_X32P_DRV Select the drive strength of the pad. (R/W)

RTCIO_XTAL_X32P_HOLD Set to 1 to hold the output value on the pad, 0 for normal operation. (R/W)

RTCIO_XTAL_X32P_RDE 1: Pull-down on pad enabled; 0: Pull-down disabled. (R/W)

RTCIO_XTAL_X32P_RUE 1: Pull-up on pad enabled; 0: Pull-up disabled. (R/W)

RTCIO_XTAL_DAC_XTAL_32K 32K XTAL bias current DAC value. (R/W)

RTCIO_XTAL_XPD_XTAL_32K Power up 32 KHz crystal oscillator. (R/W)

RTCIO_XTAL_X32N_MUX_SEL 1: route X32N pad to the digital IO_MUX, 0: route to RTC block. (R/W)

RTCIO_XTAL_X32P_MUX_SEL 1: route X32P pad to the digital IO_MUX, 0: route to RTC block. (R/W)

RTCIO_XTAL_X32N_FUN_SEL Select the RTC function. 0: select function0; 1: select function1. (R/W)

RTCIO_XTAL_X32N_SLP_SEL Sleep mode selection. Set this bit to 1 to put the pad to sleep. (R/W)

RTCIO_XTAL_X32N_SLP_IE Input enable of the pad in sleep mode. 1: enabled; 0: disabled. (R/W)

RTCIO_XTAL_X32N_SLP_OE Output enable of the pad. 1: enabled; 0: disabled. (R/W)

RTCIO_XTAL_X32N_FUN_IE Input enable of the pad. 1: enabled; 0: disabled. (R/W)

RTCIO_XTAL_X32P_FUN_SEL Select the RTC function. 0: select Function 0; 1: select Function 1. (R/W)

RTCIO_XTAL_X32P_SLP_SEL Sleep mode selection. Set this bit to 1 to put the pad to sleep. (R/W)

RTCIO_XTAL_X32P_SLP_IE Input enable of the pad in sleep mode. 1: enabled; 0: disabled. (R/W)

RTCIO_XTAL_X32P_SLP_OE Output enable of the pad in sleep mode. 1: enabled; 0: disabled. (R/W)

RTCIO_XTAL_X32P_FUN_IE Input enable of the pad. 1: enabled; 0: disabled. (R/W)

RTCIO_XTAL_DRES_XTAL_32K 32K XTAL resistor bias control. (R/W)

RTCIO_XTAL_DBIAS_XTAL_32K 32K XTAL self-bias reference control. (R/W)

Register 4.52: RTCIO_TOUCH_CFG_REG (0x0024)

	RTCIO_TOUCH_XPD_BIAS		RTCIO_TOUCH_DREFH		RTCIO_TOUCH_DREFL		RTCIO_TOUCH_DRANGE		RTCIO_TOUCH_DCUR		(reserved)																										
31	30	29	28	27	26	25	24	23	45																											23	
0	1	1	0	0	1	1	0	0	0	0	0	0	0	0	0	0	0	0	0	0	0	0	0	0	0	0	0	0	0	0	0	0	0	0	0	0	Reset

RTCIO_TOUCH_XPD_BIAS Touch sensor bias power on bit. 1: power on; 0: disabled. (R/W)

RTCIO_TOUCH_DREFH Touch sensor saw wave top voltage. (R/W)

RTCIO_TOUCH_DREFL Touch sensor saw wave bottom voltage. (R/W)

RTCIO_TOUCH_DRANGE Touch sensor saw wave voltage range. (R/W)

RTCIO_TOUCH_DCUR Touch sensor bias current. When BIAS_SLEEP is enabled, this setting is available. (R/W)

Register 4.53: RTCIO_TOUCH_PAD_n_REG (n: 0-9) (0x25+1*n)

	(reserved)						RTCIO_TOUCH_PAD _n _DAC						RTCIO_TOUCH_PAD _n _START						RTCIO_TOUCH_PAD _n _TIE_OPT						RTCIO_TOUCH_PAD _n _XPD						RTCIO_TOUCH_PAD _n _TO_GPIO						(reserved)						
31							26	25								23	22	21	20	19	37																				19		
0	0	0	0	0	0	0	0	0	0	0	0	0	0	0	0	0	0	0	0	0	0	0	0	0	0	0	0	0	0	0	0	0	0	0	0	0	0	0	0	0	Reset		

RTCIO_TOUCH_PAD_n_DAC Touch sensor slope control. 3-bit for each touch pad, defaults to 100. (R/W)

RTCIO_TOUCH_PAD_n_START Start touch sensor. (R/W)

RTCIO_TOUCH_PAD_n_TIE_OPT Default touch sensor tie option. 0: tie low; 1: tie high. (R/W)

RTCIO_TOUCH_PAD_n_XPD Touch sensor power on. (R/W)

RTCIO_TOUCH_PAD_n_TO_GPIO Connect the RTC pad input to digital pad input, 0 is available. (R/W)

Register 4.54: RTCIO_EXT_WAKEUP0_REG (0x002f)

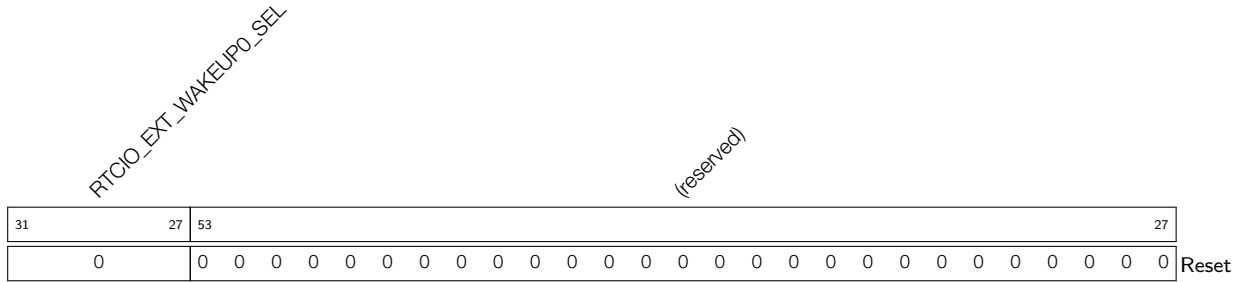

RTCIO_EXT_WAKEUP0_SEL GPIO[0-17] can be used to wake up the chip when the chip is in sleep mode. This register selects the pad source to wake up the chip in deep/light sleep mode. 0: select GPIO0; 1: select GPIO2, etc. (R/W)

Register 4.55: RTCIO_XTL_EXT_CTR_REG (0x0030)

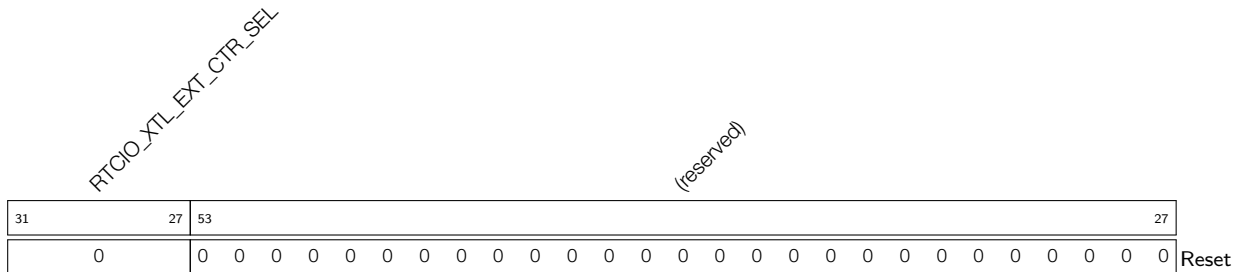

RTCIO_XTL_EXT_CTR_SEL Select the external crystal power down enable source in sleep mode. 0: select GPIO0; 1: select GPIO2, etc. The input value on this pin XOR RTCIO_RTC_EXT_XTAL_CONF_REG[30] is the crystal power down enable signal. (R/W)

Register 4.56: RTCIO_SAR_I2C_IO_REG (0x0031)

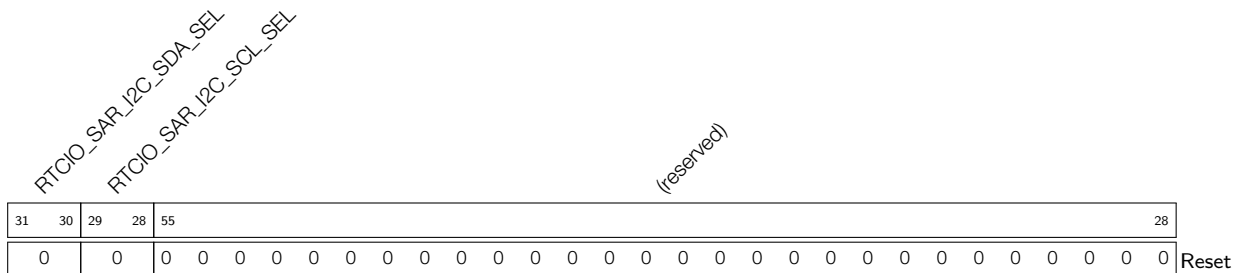

RTCIO_SAR_I2C_SDA_SEL Selects a different pad as the RTC I2C SDA signal. 0: use pad TOUCH_PAD[1]; 1: use pad TOUCH_PAD[3]. (R/W)

RTCIO_SAR_I2C_SCL_SEL Selects a different pad as the RTC I2C SCL signal. 0: use pad TOUCH_PAD[1]; 1: use pad TOUCH_PAD[3]. (R/W)

5. LED_PWM

5.1 Introduction

The LED_PWM controller is primarily designed to control the intensity of LEDs, although it can be used to generate PWM signals for other purposes as well. It has 16 channels which can generate independent waveforms that can be used to drive e.g. RGB LED devices. For maximum flexibility, the high-speed as well as the low-speed channels can be driven from one of four high-speed/low-speed timers. The PWM controller also has the ability to automatically increase or decrease the duty cycle gradually, allowing for fades without any processor interference. To increase resolution, the LED_PWM controller is also able to dither between two values when a fractional PWM value is configured.

The LED_PWM controller has eight high-speed and eight low-speed PWM generators. In this document, they will be referred to as `hschn` and `lschn` respectively. These channels can be driven from four timers, which will be indicated by `h_timerx` and `l_timerx`.

5.2 Functional Description

5.2.1 Architecture

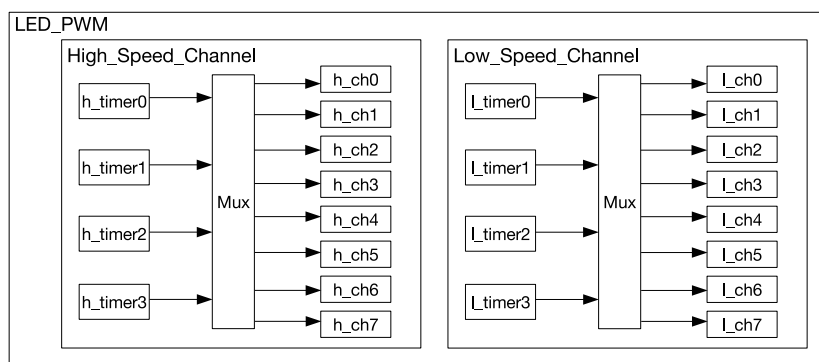

Figure 10: LED_PWM Architecture

Figure 10 shows the architecture of the LED_PWM controller. As can be seen from the figure, the LED_PWM controller contains 8 high-speed and 8 low-speed channels. There are 4 high-speed clock modules for the high-speed channels, from which one `h_timerx` can be selected. There are also 4 low-speed clock modules for the low-speed channels, from which one `l_timerx` can be selected.

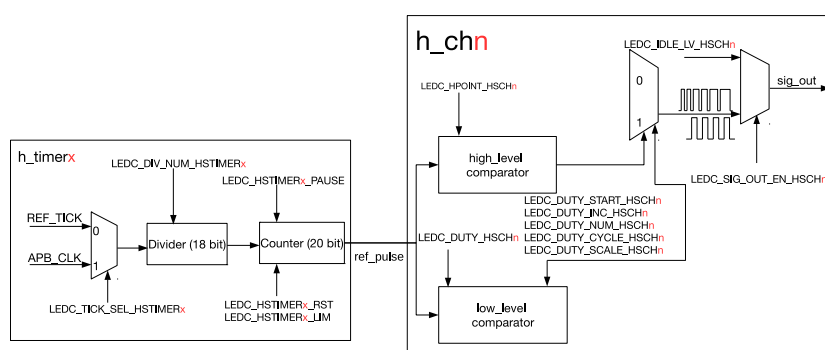

Figure 11: LED_PWM High-speed Channel Diagram

Figure 11 illustrates a PWM channel with its selected timer; in this instance a high-speed channel and associated high-speed timer.

5.2.2 Timers

A high-speed timer consists of a multiplexer to select one of two clock sources: either REF_TICK or APB_CLK. For more information on the clock sources, please refer to Chapter [Reset And Clock](#). The input clock is divided down by a divider first. The division factor is specified by LEDC_DIV_NUM_HSTIMER_x which contains a fixed point number: the highest 10 bits represent the integer portion while the lowest 8 bits contain the fractional portion.

The divided clock signal is then fed into a 20-bit counter. This counter will count up to the value specified in LEDC_HSTIMER_x_LIM. An overflow interrupt will be generated once the counting value reaches this value, at which point the counter restarts counting from 0. It is also possible to reset, suspend and read the values of the counter by software.

The output signal of the timer is the 20-bit value generated by the counter. The cycle period of this signal defines the frequency of the signals of any PWM channels connected to this timer. This frequency depends on both the division factor of the divider as well as the range of the counter:

$$f_{\text{sig_out}} = \frac{f_{\text{REF_TICK}} \cdot (!\text{LEDC_TICK_SEL_HSTIMER}_x) + f_{\text{APB_CLK}} \cdot \text{LEDC_TICK_SEL_HSTIMER}_x}{\text{LEDC_DIV_NUM_HSTIMER}_x \cdot 2^{\text{LEDC_HSTIMER}_x_LIM}}$$

The low-speed timers l_timer_x on the low-speed channel differ from the high-speed timers h_timer_x in two aspects:

1. Where the high-speed timer clock source can be clocked from REF_TICK or APB_CLK, the low speed timers are sourced from either REF_TICK or SLOW_CLOCK. The SLOW_CLOCK source can be either APB_CLK (80 MHz) or 8 MHz, selectable using LEDC_APB_CLK_SEL.
2. The high-speed counter and divider are glitch-free, meaning that if software modifies the maximum counter or divisor value, the update will come into effect after the next overflow interrupt. In contrast, the low-speed counter and divider will update these values only when LEDC_LSTIMER_x_PARA_UP is set.

5.2.3 Channels

A channel takes the 20-bit value from the counter of the selected high-speed timer and compares it to a set of two values in order to set the channel output. The first value it is compared to is the contents of LEDC_HPOINT_HSCH_n; if these two match, the output will be latched high. The second value is the sum of LEDC_HPOINT_HSCH_n and LEDC_DUTY_HSCH_n[24..4]. When this value is reached, the output is latched low. By using these two values, the relative phase and the duty cycle of the PWM output can be set. Figure 12 illustrates this.

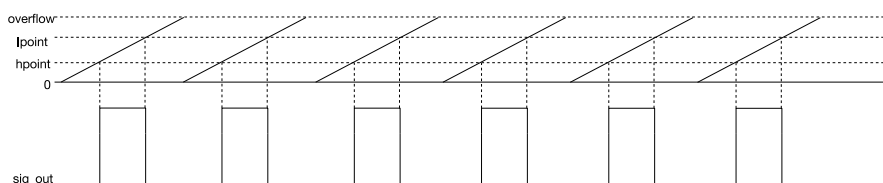

Figure 12: LED PWM Output Signal Diagram

LEDC_DUTY_HSCH n is a fixed-point register with 4 fractional bits. As stated before, LEDC_DUTY_HSCH n [24..4] is used in the PWM calculation directly, LEDC_DUTY_HSCH n [3..0] can be used to dither the output. If this value is non-zero, with a statistical chance of LEDC_DUTY_HSCH n [3..0]/16, the actual PWM pulse will be one cycle longer. This effectively increases the resolution of the PWM generator to 24 bits, but at the cost of a slight jitter in the duty cycle.

The channels also have ability to automatically fade from one duty cycle value to another. This feature is enabled by setting LEDC_DUTY_START_HSCH n . When this bit is set, the PWM controller will automatically increment or decrement the value in LEDC_DUTY_HSCH n , depending on whether the bit LEDC_DUTY_INC_HSCH n is set or cleared, respectively. The speed the duty cycle changes is defined as such: every LEDC_DUTY_CYCLE_HSCH n cycles, the content of LEDC_DUTY_SCALE_HSCH n is added to or subtracted from LEDC_DUTY_HSCH n [24..4]. The length of the fade can be limited by setting LEDC_DUTY_NUM_HSCH n : the fade will only last that number of cycles before finishing. A finished fade also generates an interrupt.

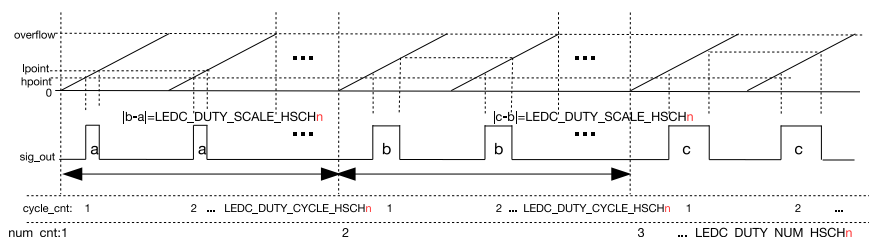

Figure 13: Output Signal Diagram of Gradient Duty Cycle

Figure 13 is an illustration of this. In this configuration, LEDC_DUTY_NUM_HSCH n _R increases by LEDC_DUTY_SCALE_HSCH n every LEDC_DUTY_CYCLE_HSCH n clock cycles, which is reflected in the duty cycle of the output signal.

5.2.4 Interrupts

- LEDC_DUTY_CHNG_END_LSCH n _INT: Triggered when a fade on a low-speed channel has finished.
- LEDC_DUTY_CHNG_END_HSCH n _INT: Triggered when a fade on a high-speed channel has finished.
- LEDC_HS_TIMER x _OVF_INT: Triggered when a high-speed timer has reached its maximum counter value.
- LEDC_LS_TIMER x _OVF_INT: Triggered when a low-speed timer has reached its maximum counter value.

5.3 Register Summary

Name	Description	Address	Access
Configuration registers			
LEDC_CONF_REG	Global ledc configuration register	0x3FF59190	R/W
LEDC_HSCH0_CONF0_REG	Configuration register 0 for high-speed channel 0	0x3FF59000	R/W
LEDC_HSCH1_CONF0_REG	Configuration register 0 for high-speed channel 1	0x3FF59014	R/W
LEDC_HSCH2_CONF0_REG	Configuration register 0 for high-speed channel 2	0x3FF59028	R/W
LEDC_HSCH3_CONF0_REG	Configuration register 0 for high-speed channel 3	0x3FF5903C	R/W
LEDC_HSCH4_CONF0_REG	Configuration register 0 for high-speed channel 4	0x3FF59050	R/W
LEDC_HSCH5_CONF0_REG	Configuration register 0 for high-speed channel 5	0x3FF59064	R/W
LEDC_HSCH6_CONF0_REG	Configuration register 0 for high-speed channel 6	0x3FF59078	R/W

Name	Description	Address	Access
LEDC_HSCH7_CONF0_REG	Configuration register 0 for high-speed channel 7	0x3FF5908C	R/W
LEDC_HSCH0_CONF1_REG	Configuration register 1 for high-speed channel 0	0x3FF5900C	R/W
LEDC_HSCH1_CONF1_REG	Configuration register 1 for high-speed channel 1	0x3FF59020	R/W
LEDC_HSCH2_CONF1_REG	Configuration register 1 for high-speed channel 2	0x3FF59034	R/W
LEDC_HSCH3_CONF1_REG	Configuration register 1 for high-speed channel 3	0x3FF59048	R/W
LEDC_HSCH4_CONF1_REG	Configuration register 1 for high-speed channel 4	0x3FF5905C	R/W
LEDC_HSCH5_CONF1_REG	Configuration register 1 for high-speed channel 5	0x3FF59070	R/W
LEDC_HSCH6_CONF1_REG	Configuration register 1 for high-speed channel 6	0x3FF59084	R/W
LEDC_HSCH7_CONF1_REG	Configuration register 1 for high-speed channel 7	0x3FF59098	R/W
LEDC_LSCH0_CONF0_REG	Configuration register 0 for low-speed channel 0	0x3FF590A0	R/W
LEDC_LSCH1_CONF0_REG	Configuration register 0 for low-speed channel 1	0x3FF590B4	R/W
LEDC_LSCH2_CONF0_REG	Configuration register 0 for low-speed channel 2	0x3FF590C8	R/W
LEDC_LSCH3_CONF0_REG	Configuration register 0 for low-speed channel 3	0x3FF590DC	R/W
LEDC_LSCH4_CONF0_REG	Configuration register 0 for low-speed channel 4	0x3FF590F0	R/W
LEDC_LSCH5_CONF0_REG	Configuration register 0 for low-speed channel 5	0x3FF59104	R/W
LEDC_LSCH6_CONF0_REG	Configuration register 0 for low-speed channel 6	0x3FF59118	R/W
LEDC_LSCH7_CONF0_REG	Configuration register 0 for low-speed channel 7	0x3FF5912C	R/W
LEDC_LSCH0_CONF1_REG	Configuration register 1 for low-speed channel 0	0x3FF590AC	R/W
LEDC_LSCH1_CONF1_REG	Configuration register 1 for low-speed channel 1	0x3FF590C0	R/W
LEDC_LSCH2_CONF1_REG	Configuration register 1 for low-speed channel 2	0x3FF590D4	R/W
LEDC_LSCH3_CONF1_REG	Configuration register 1 for low-speed channel 3	0x3FF590E8	R/W
LEDC_LSCH4_CONF1_REG	Configuration register 1 for low-speed channel 4	0x3FF590FC	R/W
LEDC_LSCH5_CONF1_REG	Configuration register 1 for low-speed channel 5	0x3FF59110	R/W
LEDC_LSCH6_CONF1_REG	Configuration register 1 for low-speed channel 6	0x3FF59124	R/W
LEDC_LSCH7_CONF1_REG	Configuration register 1 for low-speed channel 7	0x3FF59138	R/W
Duty-cycle registers			
LEDC_HSCH0_DUTY_REG	Initial duty cycle for high-speed channel 0	0x3FF59008	R/W
LEDC_HSCH1_DUTY_REG	Initial duty cycle for high-speed channel 1	0x3FF5901C	R/W
LEDC_HSCH2_DUTY_REG	Initial duty cycle for high-speed channel 2	0x3FF59030	R/W
LEDC_HSCH3_DUTY_REG	Initial duty cycle for high-speed channel 3	0x3FF59044	R/W
LEDC_HSCH4_DUTY_REG	Initial duty cycle for high-speed channel 4	0x3FF59058	R/W
LEDC_HSCH5_DUTY_REG	Initial duty cycle for high-speed channel 5	0x3FF5906C	R/W
LEDC_HSCH6_DUTY_REG	Initial duty cycle for high-speed channel 6	0x3FF59080	R/W
LEDC_HSCH7_DUTY_REG	Initial duty cycle for high-speed channel 7	0x3FF59094	R/W
LEDC_HSCH0_DUTY_R_REG	Current duty cycle for high-speed channel 0	0x3FF59010	RO
LEDC_HSCH1_DUTY_R_REG	Current duty cycle for high-speed channel 1	0x3FF59024	RO
LEDC_HSCH2_DUTY_R_REG	Current duty cycle for high-speed channel 2	0x3FF59038	RO
LEDC_HSCH3_DUTY_R_REG	Current duty cycle for high-speed channel 3	0x3FF5904C	RO
LEDC_HSCH4_DUTY_R_REG	Current duty cycle for high-speed channel 4	0x3FF59060	RO
LEDC_HSCH5_DUTY_R_REG	Current duty cycle for high-speed channel 5	0x3FF59074	RO
LEDC_HSCH6_DUTY_R_REG	Current duty cycle for high-speed channel 6	0x3FF59088	RO
LEDC_HSCH7_DUTY_R_REG	Current duty cycle for high-speed channel 7	0x3FF5909C	RO
LEDC_LSCH0_DUTY_REG	Initial duty cycle for low-speed channel 0	0x3FF590A8	R/W
LEDC_LSCH1_DUTY_REG	Initial duty cycle for low-speed channel 1	0x3FF590BC	R/W

Name	Description	Address	Access
LEDC_LSCH2_DUTY_REG	Initial duty cycle for low-speed channel 2	0x3FF590D0	R/W
LEDC_LSCH3_DUTY_REG	Initial duty cycle for low-speed channel 3	0x3FF590E4	R/W
LEDC_LSCH4_DUTY_REG	Initial duty cycle for low-speed channel 4	0x3FF590F8	R/W
LEDC_LSCH5_DUTY_REG	Initial duty cycle for low-speed channel 5	0x3FF5910C	R/W
LEDC_LSCH6_DUTY_REG	Initial duty cycle for low-speed channel 6	0x3FF59120	R/W
LEDC_LSCH7_DUTY_REG	Initial duty cycle for low-speed channel 7	0x3FF59134	R/W
LEDC_LSCH0_DUTY_R_REG	Current duty cycle for low-speed channel 0	0x3FF590B0	RO
LEDC_LSCH1_DUTY_R_REG	Current duty cycle for low-speed channel 1	0x3FF590C4	RO
LEDC_LSCH2_DUTY_R_REG	Current duty cycle for low-speed channel 2	0x3FF590D8	RO
LEDC_LSCH3_DUTY_R_REG	Current duty cycle for low-speed channel 3	0x3FF590EC	RO
LEDC_LSCH4_DUTY_R_REG	Current duty cycle for low-speed channel 4	0x3FF59100	RO
LEDC_LSCH5_DUTY_R_REG	Current duty cycle for low-speed channel 5	0x3FF59114	RO
LEDC_LSCH6_DUTY_R_REG	Current duty cycle for low-speed channel 6	0x3FF59128	RO
LEDC_LSCH7_DUTY_R_REG	Current duty cycle for low-speed channel 7	0x3FF5913C	RO
Timer registers			
LEDC_HSTIMER0_CONF_REG	High-speed timer 0 configuration	0x3FF59140	R/W
LEDC_HSTIMER1_CONF_REG	High-speed timer 1 configuration	0x3FF59148	R/W
LEDC_HSTIMER2_CONF_REG	High-speed timer 2 configuration	0x3FF59150	R/W
LEDC_HSTIMER3_CONF_REG	High-speed timer 3 configuration	0x3FF59158	R/W
LEDC_HSTIMER0_VALUE_REG	High-speed timer 0 current counter value	0x3FF59144	RO
LEDC_HSTIMER1_VALUE_REG	High-speed timer 1 current counter value	0x3FF5914C	RO
LEDC_HSTIMER2_VALUE_REG	High-speed timer 2 current counter value	0x3FF59154	RO
LEDC_HSTIMER3_VALUE_REG	High-speed timer 3 current counter value	0x3FF5915C	RO
LEDC_LSTIMER0_CONF_REG	Low-speed timer 0 configuration	0x3FF59140	R/W
LEDC_LSTIMER1_CONF_REG	Low-speed timer 1 configuration	0x3FF59148	R/W
LEDC_LSTIMER2_CONF_REG	Low-speed timer 2 configuration	0x3FF59150	R/W
LEDC_LSTIMER3_CONF_REG	Low-speed timer 3 configuration	0x3FF59158	R/W
LEDC_LSTIMER0_VALUE_REG	Low-speed timer 0 current counter value	0x3FF59144	RO
LEDC_LSTIMER1_VALUE_REG	Low-speed timer 1 current counter value	0x3FF5914C	RO
LEDC_LSTIMER2_VALUE_REG	Low-speed timer 2 current counter value	0x3FF59154	RO
LEDC_LSTIMER3_VALUE_REG	Low-speed timer 3 current counter value	0x3FF5915C	RO
Interrupt registers			
LEDC_INT_RAW_REG	Raw interrupt status	0x3FF59180	RO
LEDC_INT_ST_REG	Masked interrupt status	0x3FF59184	RO
LEDC_INT_ENA_REG	Interrupt enable bits	0x3FF59188	R/W
LEDC_INT_CLR_REG	Interrupt clear bits	0x3FF5918C	WO

5.4 Registers

Register 5.1: LEDC_HSCH n _CONF0_REG (n : 0-7) (0x1C+0x10* n)

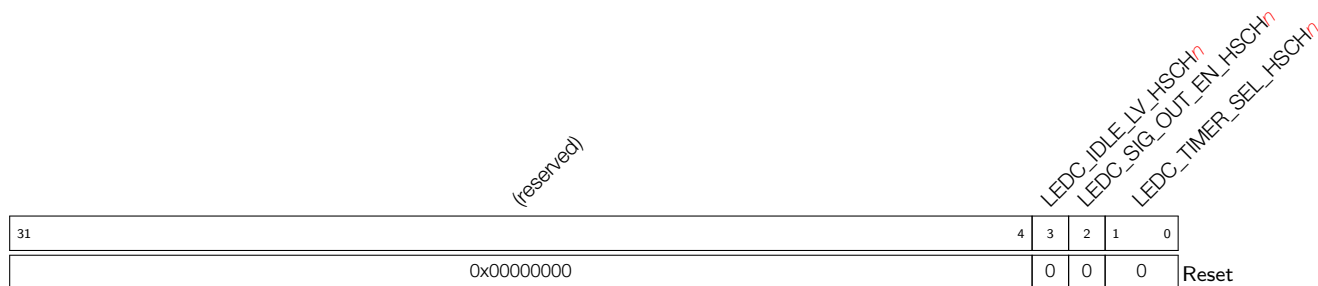

LEDC_IDLE_LV_HSCH n This bit is used to control the output value when high-speed channel n is inactive. (R/W)

LEDC_SIG_OUT_EN_HSCH n This is the output enable control bit for high-speed channel n . (R/W)

LEDC_TIMER_SEL_HSCH n There are four high-speed timers. These two bits are used to select one of them for high-speed channel n : (R/W)

- 0: select hstimer0;
- 1: select hstimer1;
- 2: select hstimer2;
- 3: select hstimer3.

Register 5.2: LEDC_HSCH n _HPOINT_REG (n : 0-7) (0x20+0x10* n)

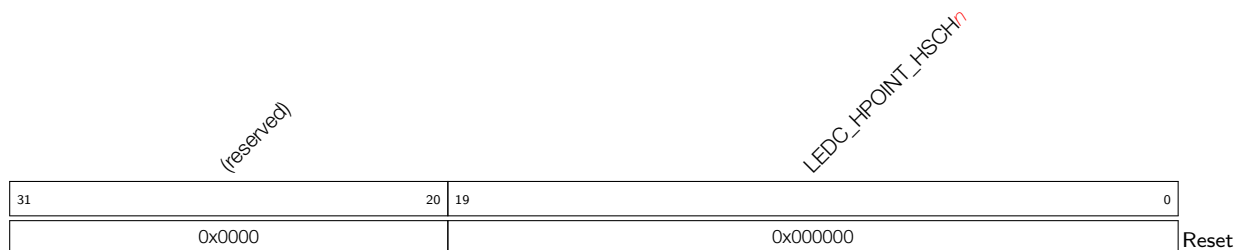

LEDC_HPOINT_HSCH n The output value changes to high when htimer x (x =[0,3]) selected by high-speed channel n has reached reg_hpoint_hsch n [19:0]. (R/W)

Register 5.3: LEDC_HSCH n _DUTY_REG (n : 0-7) (0x24+0x10* n)

(reserved)		LEDC_DUTY_HSCH n	
31	25	24	0
0x00		0x0000000	
			Reset

LEDC_DUTY_HSCH n The register is used to control output duty. When hstimerx(x =[0,3]) selected by high-speed channel n has reached reg_lpoint_hsch n , the output signal changes to low. (R/W)
 $\text{reg_lpoint_hsch}_n = (\text{reg_hpoint_hsch}_n[19:0] + \text{reg_duty_hsch}_n[24:4])$ (1)
 $\text{reg_lpoint_hsch}_n = (\text{reg_hpoint_hsch}_n[19:0] + \text{reg_duty_hsch}_n[24:4] + 1)$ (2)
 See the [Functional Description](#) for more information on when (1) or (2) is chosen.

Register 5.4: LEDC_HSCH n _CONF1_REG (n : 0-7) (0x28+0x10* n)

LEDC_DUTY_START_HSCH n		LEDC_DUTY_INC_HSCH n		LEDC_DUTY_NUM_HSCH n		LEDC_DUTY_CYCLE_HSCH n		LEDC_DUTY_SCALE_HSCH n	
31	30	29	20	19	10	9	0		
0	1	0x000		0x000		0x000			
								Reset	

LEDC_DUTY_START_HSCH n When REG_DUTY_NUM_HSCH n , REG_DUTY_CYCLE_HSCH n and REG_DUTY_SCALE_HSCH n has been configured, these register won't take effect until REG_DUTY_START_HSCH n is set. This bit is automatically cleared by hardware. (R/W)

LEDC_DUTY_INC_HSCH n This register is used to increase or decrease the duty of output signal for high-speed channel n . (R/W)

LEDC_DUTY_NUM_HSCH n This register is used to control the number of times the duty cycle is increased or decreased for high-speed channel n . (R/W)

LEDC_DUTY_CYCLE_HSCH n This register is used to increase or decrease the duty cycle every REG_DUTY_CYCLE_HSCH n cycles for high-speed channel n . (R/W)

LEDC_DUTY_SCALE_HSCH n This register is used to increase or decrease the step scale for high-speed channel n . (R/W)

Register 5.5: LEDC_HSCH n _DUTY_R_REG (n : 0-7) (0x2C+0x10* n)

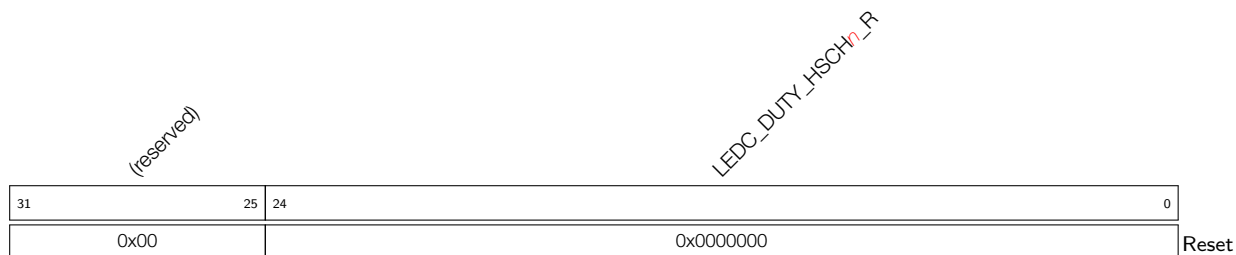

LEDC_DUTY_HSCH n _R This register represents the current duty cycle of the output signal for high-speed channel n . (RO)

Register 5.6: LEDC_LSCH n _CONF0_REG (n : 0-7) (0xBC+0x10* n)

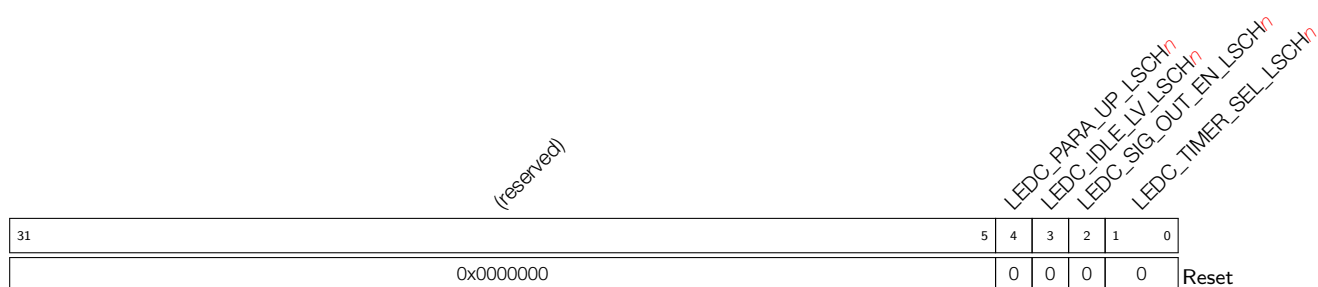

LEDC_PARA_UP_LSCH n This bit is used to update register LEDC_LSCH n _HPOINT and LEDC_LSCH n _DUTY for low-speed channel n . (R/W)

LEDC_IDLE_LV_LSCH n This bit is used to control the output value when low-speed channel n is inactive. (R/W)

LEDC_SIG_OUT_EN_LSCH n This is the output enable control bit for low-speed channel n . (R/W)

LEDC_TIMER_SEL_LSCH n There are four low speed timers, the two bits are used to select one of them for low-speed channel n . (R/W)

- 0: select Istimer0;
- 1: select Istimer1;
- 2: select Istimer2;
- 3: select Istimer3.

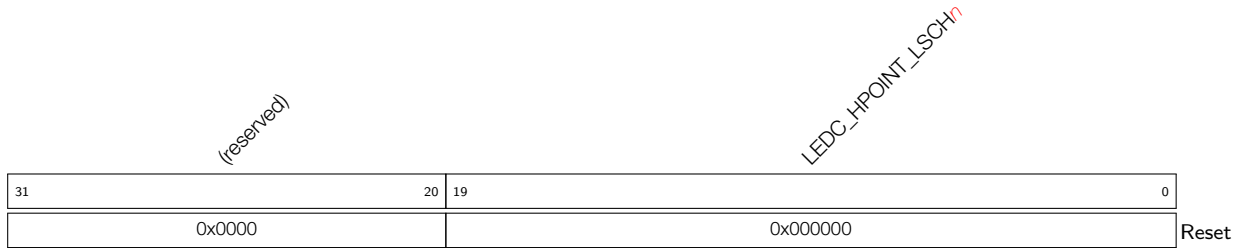
Register 5.7: LEDC_LSCH n _HPOINT_REG (n : 0-7) (0xC0+0x10* n)

LEDC_HPOINT_LSCH n The output value changes to high when ltimerx(x =[0,3]) selected by low-speed channel n has reached reg_hpoint_lschn[19:0]. (R/W)

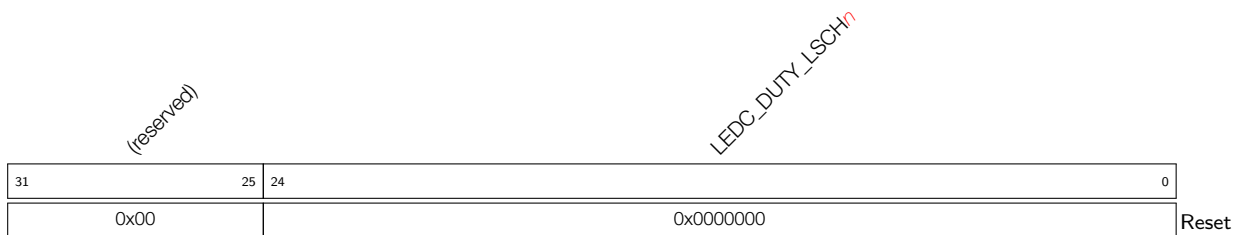
Register 5.8: LEDC_LSCH n _DUTY_REG (n : 0-7) (0xC4+0x10* n)

LEDC_DUTY_LSCH n The register is used to control output duty. When ltimerx(x =[0,3]) chosen by low-speed channel n has reached reg_lpoint_lschn, the output signal changes to low. (R/W)

reg_lpoint_lschn=(reg_hpoint_lschn[19:0]+reg_duty_lschn[24:4]) (1)

reg_lpoint_lschn=(reg_hpoint_lschn[19:0]+reg_duty_lschn[24:4] +1) (2)

See the [Functional Description](#) for more information on when (1) or (2) is chosen.

Register 5.9: LEDC_LSCH n _CONF1_REG (n : 0-7) (0xC8+0x10* n)

LEDC_DUTY_START_LSCH n LEDC_DUTY_INC_LSCH n			LEDC_DUTY_NUM_LSCH n							LEDC_DUTY_CYCLE_LSCH n										LEDC_DUTY_SCALE_LSCH n																																						
31	30	29																		20	19																		10	9																		0
0	1	0x000																	0x000																	0x000																	Reset					

LEDC_DUTY_START_LSCH n When `reg_duty_num_hsch n` , `reg_duty_cycle_hsch n` and `reg_duty_scale_hsch n` has been configured, these settings won't take effect until set `reg_duty_start_hsch n` . This bit is automatically cleared by hardware. (R/W)

LEDC_DUTY_INC_LSCH n This register is used to increase or decrease the duty of output signal for low-speed channel n . (R/W)

LEDC_DUTY_NUM_LSCH n This register is used to control the number of times the duty cycle is increased or decreased for low-speed channel n . (R/W)

LEDC_DUTY_CYCLE_LSCH n This register is used to increase or decrease the duty every `reg_duty_cycle_lschn` cycles for low-speed channel n . (R/W)

LEDC_DUTY_SCALE_LSCH n This register is used to increase or decrease the step scale for low-speed channel n . (R/W)

Register 5.10: LEDC_LSCH n _DUTY_R_REG (n : 0-7) (0xCC+0x10* n)

(reserved)																	LEDC_DUTY_LSCH n _R																				
31																		25	24																		0
0x00																	0x0000000														Reset						

LEDC_DUTY_LSCH n _R This register represents the current duty of the output signal for low-speed channel n . (RO)

Register 5.11: LEDC_HSTIMER_x_CONF_REG (x: 0-3) (0x140+8*x)

(reserved)				LEDC_TICK_SEL_HSTIMER _x			LEDC_DIV_NUM_HSTIMER _x								LEDC_HSTIMER _x _LIM	
31	26	25	24	23	22	5	4							0		
0x00			0	1	0	0x00000						0x00		Reset		

LEDC_TICK_SEL_HSTIMER_x This bit is used to select APB_CLK or REF_TICK for high-speed timer _x. (R/W)

1: APB_CLK;
0: REF_TICK.

LEDC_HSTIMER_x_RST This bit is used to reset high-speed timer _x. The counter value will be 0 after reset. (R/W)

LEDC_HSTIMER_x_PAUSE This bit is used to suspend the counter in high-speed timer _x. (R/W)

LEDC_DIV_NUM_HSTIMER_x This register is used to configure the division factor for the divider in high-speed timer _x. The least significant eight bits represent the fractional part. (R/W)

LEDC_HSTIMER_x_LIM This register is used to control the range of the counter in high-speed timer _x. The counter range is $[0, 2^{**}reg_hstimer_lim]$, the maximum bit width for counter is 20. (R/W)

Register 5.12: LEDC_HSTIMER_x_VALUE_REG (x: 0-3) (0x144+8*x)

(reserved)																LEDC_HSTIMER _x _CNT																
31																20	19															0
0x0000																0 0																Reset

LEDC_HSTIMER_x_CNT Software can read this register to get the current counter value of high-speed timer _x. (RO)

Register 5.13: LEDC_LSTIMER_x_CONF_REG (x: 0-3) (0x160+8*x)

(reserved)					LEDC_LSTIMER _x _PARAM_UP								LEDC_DIV_NUM_LSTIMER _x								LEDC_LSTIMER _x _LIM			
LEDC_TICK_SEL_LSTIMER _x					LEDC_LSTIMER _x _RST								LEDC_LSTIMER _x _PAUSE											
31	27	26	25	24	23	22									5	4					0			
0x00					0	0	1	0	0x00000								0x00				Reset			

LEDC_LSTIMER_x_PARAM_UP Set this bit to update REG_DIV_NUM_LSTIME_x and REG_LSTIMER_x_LIM. (R/W)

LEDC_TICK_SEL_LSTIMER_x This bit is used to select SLOW_CLK or REF_TICK for low-speed timer *x*. (R/W)
 1: SLOW_CLK;
 0: REF_TICK.

LEDC_LSTIMER_x_RST This bit is used to reset low-speed timer *x*. The counter will be 0 after reset. (R/W)

LEDC_LSTIMER_x_PAUSE This bit is used to suspend the counter in low-speed timer *x*. (R/W)

LEDC_DIV_NUM_LSTIMER_x This register is used to configure the division factor for the divider in low-speed timer *x*. The least significant eight bits represent the fractional part. (R/W)

LEDC_LSTIMER_x_LIM This register is used to control the range of the counter in low-speed timer *x*. The counter range is [0,2**reg_lstimer_x_lim], the max bit width for counter is 20. (R/W)

Register 5.14: LEDC_LSTIMER_x_VALUE_REG (x: 0-3) (0x164+8*x)

(reserved)																LEDC_LSTIMER _x _CNT																
31																20	19															0
0x0000																0 0																Reset

LEDC_LSTIMER_x_CNT Software can read this register to get the current counter value of low-speed timer *x*. (RO)

Register 5.15: LEDC_INT_RAW_REG (0x0180)

(reserved)								LEDC_DUTY_CHNG_END_LSCH7_INT_RAW																							
(reserved)								LEDC_DUTY_CHNG_END_LSCH6_INT_RAW																							
(reserved)								LEDC_DUTY_CHNG_END_LSCH5_INT_RAW																							
(reserved)								LEDC_DUTY_CHNG_END_LSCH4_INT_RAW																							
(reserved)								LEDC_DUTY_CHNG_END_LSCH3_INT_RAW																							
(reserved)								LEDC_DUTY_CHNG_END_LSCH2_INT_RAW																							
(reserved)								LEDC_DUTY_CHNG_END_LSCH1_INT_RAW																							
(reserved)								LEDC_DUTY_CHNG_END_HSCH0_INT_RAW																							
(reserved)								LEDC_DUTY_CHNG_END_HSCH7_INT_RAW																							
(reserved)								LEDC_DUTY_CHNG_END_HSCH6_INT_RAW																							
(reserved)								LEDC_DUTY_CHNG_END_HSCH5_INT_RAW																							
(reserved)								LEDC_DUTY_CHNG_END_HSCH4_INT_RAW																							
(reserved)								LEDC_DUTY_CHNG_END_HSCH3_INT_RAW																							
(reserved)								LEDC_DUTY_CHNG_END_HSCH2_INT_RAW																							
(reserved)								LEDC_DUTY_CHNG_END_HSCH1_INT_RAW																							
(reserved)								LEDC_LSTIMER3_OVF_INT_RAW																							
(reserved)								LEDC_LSTIMER2_OVF_INT_RAW																							
(reserved)								LEDC_LSTIMER1_OVF_INT_RAW																							
(reserved)								LEDC_HSTIMER3_OVF_INT_RAW																							
(reserved)								LEDC_HSTIMER2_OVF_INT_RAW																							
(reserved)								LEDC_HSTIMER1_OVF_INT_RAW																							
(reserved)								LEDC_HSTIMER0_OVF_INT_RAW																							
31	24	23	22	21	20	19	18	17	16	15	14	13	12	11	10	9	8	7	6	5	4	3	2	1	0	Reset					
0	0	0	0	0	0	0	0	0	0	0	0	0	0	0	0	0	0	0	0	0	0	0	0	0	0	0	0	0			

LEDC_DUTY_CHNG_END_LSCH n _INT_RAW The raw interrupt status bit for the [LEDC_DUTY_CHNG_END_LSCH \$n\$ _INT](#) interrupt. (RO)

LEDC_DUTY_CHNG_END_HSCH n _INT_RAW The raw interrupt status bit for the [LEDC_DUTY_CHNG_END_HSCH \$n\$ _INT](#) interrupt. (RO)

LEDC_LSTIMER x _OVF_INT_RAW The raw interrupt status bit for the [LEDC_LSTIMER \$x\$ _OVF_INT](#) interrupt. (RO)

LEDC_HSTIMER x _OVF_INT_RAW The raw interrupt status bit for the [LEDC_HSTIMER \$x\$ _OVF_INT](#) interrupt. (RO)

Register 5.16: LEDC_INT_ST_REG (0x0184)

(reserved)								LEDC_DUTY_CHNG_END_LSCH7_INT_ST																							
(reserved)								LEDC_DUTY_CHNG_END_LSCH6_INT_ST																							
(reserved)								LEDC_DUTY_CHNG_END_LSCH5_INT_ST																							
(reserved)								LEDC_DUTY_CHNG_END_LSCH4_INT_ST																							
(reserved)								LEDC_DUTY_CHNG_END_LSCH3_INT_ST																							
(reserved)								LEDC_DUTY_CHNG_END_LSCH2_INT_ST																							
(reserved)								LEDC_DUTY_CHNG_END_LSCH1_INT_ST																							
(reserved)								LEDC_DUTY_CHNG_END_HSCH0_INT_ST																							
(reserved)								LEDC_DUTY_CHNG_END_HSCH7_INT_ST																							
(reserved)								LEDC_DUTY_CHNG_END_HSCH6_INT_ST																							
(reserved)								LEDC_DUTY_CHNG_END_HSCH5_INT_ST																							
(reserved)								LEDC_DUTY_CHNG_END_HSCH4_INT_ST																							
(reserved)								LEDC_DUTY_CHNG_END_HSCH3_INT_ST																							
(reserved)								LEDC_DUTY_CHNG_END_HSCH2_INT_ST																							
(reserved)								LEDC_DUTY_CHNG_END_HSCH1_INT_ST																							
(reserved)								LEDC_LSTIMER3_OVF_INT_ST																							
(reserved)								LEDC_LSTIMER2_OVF_INT_ST																							
(reserved)								LEDC_LSTIMER1_OVF_INT_ST																							
(reserved)								LEDC_HSTIMER3_OVF_INT_ST																							
(reserved)								LEDC_HSTIMER2_OVF_INT_ST																							
(reserved)								LEDC_HSTIMER1_OVF_INT_ST																							
(reserved)								LEDC_HSTIMER0_OVF_INT_ST																							
31	24	23	22	21	20	19	18	17	16	15	14	13	12	11	10	9	8	7	6	5	4	3	2	1	0	Reset					
0	0	0	0	0	0	0	0	0	0	0	0	0	0	0	0	0	0	0	0	0	0	0	0	0	0	0	0				

LEDC_DUTY_CHNG_END_LSCH n _INT_ST The masked interrupt status bit for the [LEDC_DUTY_CHNG_END_LSCH \$n\$ _INT](#) interrupt. (RO)

LEDC_DUTY_CHNG_END_HSCH n _INT_ST The masked interrupt status bit for the [LEDC_DUTY_CHNG_END_HSCH \$n\$ _INT](#) interrupt. (RO)

LEDC_LSTIMER x _OVF_INT_ST The masked interrupt status bit for the [LEDC_LSTIMER \$x\$ _OVF_INT](#) interrupt. (RO)

LEDC_HSTIMER x _OVF_INT_ST The masked interrupt status bit for the [LEDC_HSTIMER \$x\$ _OVF_INT](#) interrupt. (RO)

Register 5.17: LEDC_INT_ENA_REG (0x0188)

(reserved)								LEDC_DUTY_CHNG_END_LSCH7_INT_ENA LEDC_DUTY_CHNG_END_LSCH6_INT_ENA LEDC_DUTY_CHNG_END_LSCH5_INT_ENA LEDC_DUTY_CHNG_END_LSCH4_INT_ENA LEDC_DUTY_CHNG_END_LSCH3_INT_ENA LEDC_DUTY_CHNG_END_LSCH2_INT_ENA LEDC_DUTY_CHNG_END_LSCH1_INT_ENA LEDC_DUTY_CHNG_END_HSCH7_INT_ENA LEDC_DUTY_CHNG_END_HSCH6_INT_ENA LEDC_DUTY_CHNG_END_HSCH5_INT_ENA LEDC_DUTY_CHNG_END_HSCH4_INT_ENA LEDC_DUTY_CHNG_END_HSCH3_INT_ENA LEDC_DUTY_CHNG_END_HSCH2_INT_ENA LEDC_DUTY_CHNG_END_HSCH1_INT_ENA LEDC_LSTIMER3_OVF_INT_ENA LEDC_LSTIMER2_OVF_INT_ENA LEDC_LSTIMER1_OVF_INT_ENA LEDC_HSTIMER3_OVF_INT_ENA LEDC_HSTIMER2_OVF_INT_ENA LEDC_HSTIMER1_OVF_INT_ENA LEDC_HSTIMER0_OVF_INT_ENA																							
31	24	23	22	21	20	19	18	17	16	15	14	13	12	11	10	9	8	7	6	5	4	3	2	1	0	Reset					
0	0	0	0	0	0	0	0	0	0	0	0	0	0	0	0	0	0	0	0	0	0	0	0	0	0	0	0	0			

LEDC_DUTY_CHNG_END_LSCH n _INT_ENA The interrupt enable bit for the [LEDC_DUTY_CHNG_END_LSCH \$n\$ _INT](#) interrupt. (R/W)

LEDC_DUTY_CHNG_END_HSCH n _INT_ENA The interrupt enable bit for the [LEDC_DUTY_CHNG_END_HSCH \$n\$ _INT](#) interrupt. (R/W)

LEDC_LSTIMER x _OVF_INT_ENA The interrupt enable bit for the [LEDC_LSTIMER \$x\$ _OVF_INT](#) interrupt. (R/W)

LEDC_HSTIMER x _OVF_INT_ENA The interrupt enable bit for the [LEDC_HSTIMER \$x\$ _OVF_INT](#) interrupt. (R/W)

Register 5.18: LEDC_INT_CLR_REG (0x018C)

(reserved)								LEDC_DUTY_CHNG_END_LSCH7_INT_CLR LEDC_DUTY_CHNG_END_LSCH6_INT_CLR LEDC_DUTY_CHNG_END_LSCH5_INT_CLR LEDC_DUTY_CHNG_END_LSCH4_INT_CLR LEDC_DUTY_CHNG_END_LSCH3_INT_CLR LEDC_DUTY_CHNG_END_LSCH2_INT_CLR LEDC_DUTY_CHNG_END_LSCH1_INT_CLR LEDC_DUTY_CHNG_END_HSCH7_INT_CLR LEDC_DUTY_CHNG_END_HSCH6_INT_CLR LEDC_DUTY_CHNG_END_HSCH5_INT_CLR LEDC_DUTY_CHNG_END_HSCH4_INT_CLR LEDC_DUTY_CHNG_END_HSCH3_INT_CLR LEDC_DUTY_CHNG_END_HSCH2_INT_CLR LEDC_DUTY_CHNG_END_HSCH1_INT_CLR LEDC_LSTIMER3_OVF_INT_CLR LEDC_LSTIMER2_OVF_INT_CLR LEDC_LSTIMER1_OVF_INT_CLR LEDC_HSTIMER3_OVF_INT_CLR LEDC_HSTIMER2_OVF_INT_CLR LEDC_HSTIMER1_OVF_INT_CLR LEDC_HSTIMER0_OVF_INT_CLR																							
31	24	23	22	21	20	19	18	17	16	15	14	13	12	11	10	9	8	7	6	5	4	3	2	1	0	Reset					
0	0	0	0	0	0	0	0	0	0	0	0	0	0	0	0	0	0	0	0	0	0	0	0	0	0	0	0				

LEDC_DUTY_CHNG_END_LSCH n _INT_CLR Set this bit to clear the [LEDC_DUTY_CHNG_END_LSCH \$n\$ _INT](#) interrupt. (WO)

LEDC_DUTY_CHNG_END_HSCH n _INT_CLR Set this bit to clear the [LEDC_DUTY_CHNG_END_HSCH \$n\$ _INT](#) interrupt. (WO)

LEDC_LSTIMER x _OVF_INT_CLR Set this bit to clear the [LEDC_LSTIMER \$x\$ _OVF_INT](#) interrupt. (WO)

LEDC_HSTIMER x _OVF_INT_CLR Set this bit to clear the [LEDC_HSTIMER \$x\$ _OVF_INT](#) interrupt. (WO)

Register 5.19: LEDC_CONF_REG (0x0190)

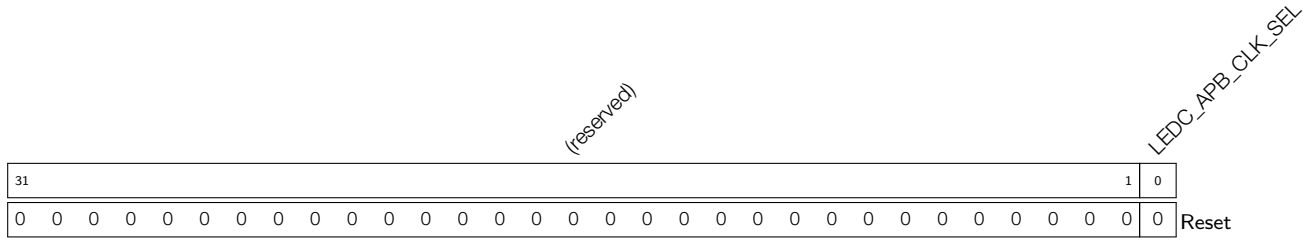

LEDC_APB_CLK_SEL This bit is used to set the frequency of SLOW_CLK. (R/W)
 0: 8 MHz;
 1: 80 MHz.

6. Remote Controller Peripheral

6.1 Introduction

The RMT (Remote Control) module is primarily designed to send and receive infrared remote control signals that use on-off-keying of a carrier frequency, but due to its design it can be used to generate various types of signals. An RMT transmitter does this by reading consecutive duration values for an active and inactive output from the built-in RAM block, optionally modulating it with a carrier wave. A receiver will inspect its input signal, optionally filtering it, and will place the lengths of time the signal is active and inactive in the RAM block.

The RMT module has eight channels, numbered 0 to 7; registers, signals and blocks that are duplicated every channel are indicated by an n as a placeholder for the channel number.

6.2 Functional Description

6.2.1 RMT Architecture

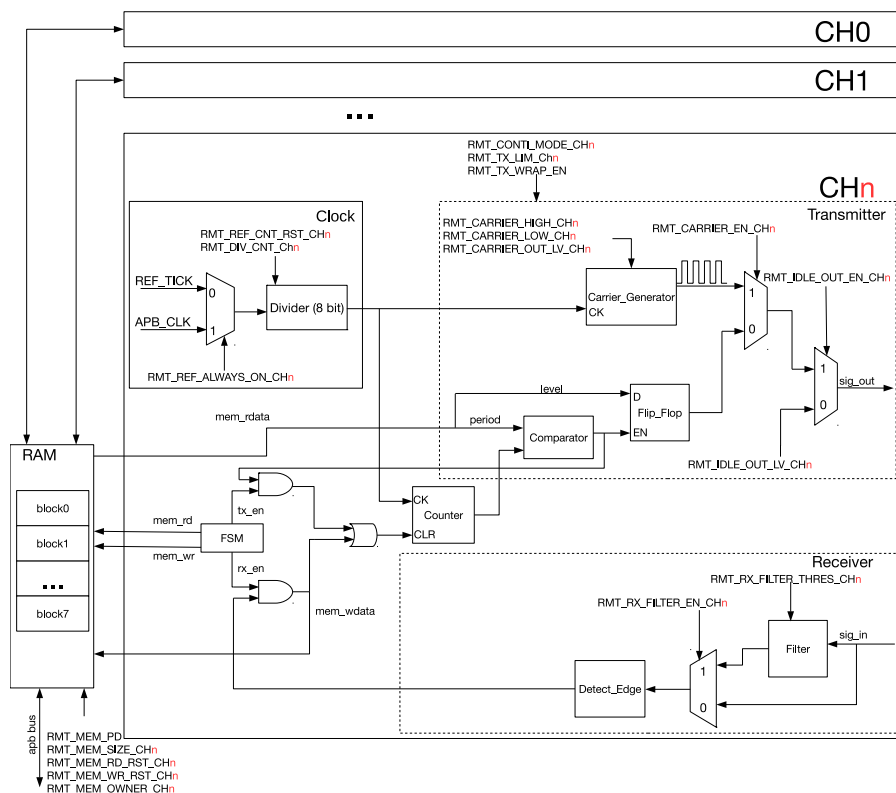

Figure 14: RMT Architecture

The RMT module contains eight channels; each channel has a transmitter and receiver, of which one can be active per channel. The 8 channels share a 512x32-bit RAM block which can be read and written by the processor cores over the APB bus, as well as read by the transmitters and written by the receivers. The transmitted signal can optionally be modulated by a carrier wave. Each channel is clocked by a divided-down signal derived from either the APB bus clock or REF_TICK.

6.2.2 RMT RAM

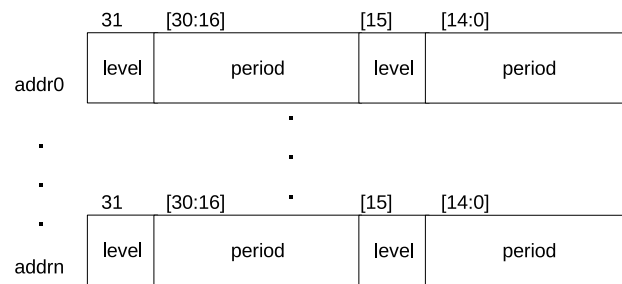

Figure 15: Data Structure

The data structure in RAM is shown in Figure 15. Each 32-bit value contains two 16-bit entries, containing two fields each: "level" indicates whether a high-level or a low-level value is to be sent or was received, "period" is the duration (in channel clock periods) for which the level lasts. A period of zero is interpreted as an end marker: the transmitter will stop transmitting once it has read this and the receiver will write this once it has detected that the signal it received has gone idle.

Normally, only one block of 64x32-bit worth of data can be sent or received. If the data size is larger than this block size, blocks can either be extended or the channel can be configured for wraparound mode.

The RMT RAM can be accessed via APB bus. The initial address is RMT base address + 0x800. The RAM block is divided into eight 64x32-bit blocks. By default, each channel uses one block (block 0 for channel 0, block 1 for channel 1, and so on). Users can extend the memory for a specific channel by configuring RMT_MEM_SIZE_CH n register; setting this to >1 will make the channel also use the memory of subsequent channels. The RAM address range for channel n is start_addr_CH n to end_addr_CH n , which are defined by:

start_addr_ch n = RMT base address + 0x800 + 64 * 4 * n , and

end_addr_ch n = RMT base address + 0x800 + 64 * 4 * n + 64 * 4 * RMT_MEM_SIZE_CH n mod 512 * 4

To protect a receiver from overwriting the blocks a transmitter is about to transmit, RMT_MEM_OWNER_CH n can be configured to assign the owner, i.e. transmitter or receiver, of channel n 's RAM block. If this ownership is violated, the RMT_CH n _ERR interrupt will be generated.

6.2.3 Clock

The main clock for a channel is generated by taking either the 80 MHz APB clock or REF_TICK (usually 1MHz), according to the state of RMT_REF_ALWAYS_ON_CH n . For more information on the clock sources, please refer to Chapter [Reset And Clock](#). This gets then scaled down using a configurable 8-bit divider to create the channel clock, to be used by both the carrier wave generator as well as by the counter. The divider value can be set by configuring RMT_DIV_CNT_CH n .

6.2.4 Transmitter

When the RMT_TX_START_CH n register is 1, the transmitter of channel n will start reading data from RAM and sending it. The transmitter will receive a 32-bits value each time it reads from RAM. Of these 32 bits, the low 16-bit entry is sent first, the high entry second.

To transmit more data than fits in the channels RAM, wraparound mode can be enabled. In this mode, when the transmitter has reached the last entry in the channels memory, it will loop back to the first byte. To use this mechanism to send more data than fits in the channels RAM, fill the RAM with the initial events and set RMT_CH n _TX_LIM_REG to cause an RMT_CH n _TX_THR_EVENT_INT interrupt before the wraparound

happens. Then, when the interrupt happens, the data that was already sent should be replaced with subsequent events: when the wraparound happens the transmitter will seamlessly continue sending the new events.

With or without wraparound mode enabled, transmission ends when an entry with a length of 0 is encountered. When this happens, the transmitter will generate a `RMT_CH n _TX_END_INT` interrupt, and return to the idle state. When a transmitter is in the idle state users can configure `RMT_IDLE_OUT_EN_CH n` and `RMT_IDLE_OUT_LV_CH n` to control the transmitter output manually.

The output of the transmitter can be modulated using a carrier wave by setting `RMT_CARRIER_EN_CH n` . The carrier frequency and duty cycle can be configured by configuring its high and low durations, in channel clock cycles, in `RMT_CARRIER_HIGH_CH n` and `RMT_CARRIER_LOW_CH n` .

6.2.5 Receiver

When `RMT_RX_EN_CH n` is set to 1, the receiver in channel n becomes active, measuring the duration between input signal edges. These will be written as period/level value pairs to the channel RAM in the same fashion as the transmitter sends them. Receiving ends when the receiver detects no change in signal level for more than `RMT_IDLE_THRES_CH n` channel clock ticks; the receiver will write a final entry with period 0, generate an `RMT_CH n _RX_END_INT_RAW` interrupt and return to the idle state.

The receiver has an input signal filter which can be configured using `RMT_RX_FILTER_EN_CH n` : The filter will remove pulses with of length less than `RMT_RX_FILTER_THRES_CH n` APB clock periods.

When the RMT module is inactive, the RAM can be put into low-power mode by setting the `RMT_MEM_PD` register to 1.

6.2.6 Interrupts

- `RMT_CH n _TX_THR_EVENT_INT`: Triggered when the number of events the transmitter has sent matches the contents of the `RMT_CH n _TX_LIM_REG` register.
- `RMT_CH n _TX_END_INT`: Triggered when the transmitter has finished transmitting the signal.
- `RMT_CH n _RX_END_INT`: Triggered when the receiver has finished receiving a signal.

6.3 Register Summary

Name	Description	Address	Access
Configuration registers			
RMT_CH0CONF0_REG	Channel 0 config register 0	0x3FF56020	R/W
RMT_CH0CONF1_REG	Channel 0 config register 1	0x3FF56024	R/W
RMT_CH1CONF0_REG	Channel 1 config register 0	0x3FF56028	R/W
RMT_CH1CONF1_REG	Channel 1 config register 1	0x3FF5602C	R/W
RMT_CH2CONF0_REG	Channel 2 config register 0	0x3FF56030	R/W
RMT_CH2CONF1_REG	Channel 2 config register 1	0x3FF56034	R/W
RMT_CH3CONF0_REG	Channel 3 config register 0	0x3FF56038	R/W
RMT_CH3CONF1_REG	Channel 3 config register 1	0x3FF5603C	R/W
RMT_CH4CONF0_REG	Channel 4 config register 0	0x3FF56040	R/W
RMT_CH4CONF1_REG	Channel 4 config register 1	0x3FF56044	R/W
RMT_CH5CONF0_REG	Channel 5 config register 0	0x3FF56048	R/W
RMT_CH5CONF1_REG	Channel 5 config register 1	0x3FF5604C	R/W
RMT_CH6CONF0_REG	Channel 6 config register 0	0x3FF56050	R/W
RMT_CH6CONF1_REG	Channel 6 config register 1	0x3FF56054	R/W
RMT_CH7CONF0_REG	Channel 7 config register 0	0x3FF56058	R/W
RMT_CH7CONF1_REG	Channel 7 config register 1	0x3FF5605C	R/W
Interrupt registers			
RMT_INT_RAW_REG	Raw interrupt status	0x3FF560A0	RO
RMT_INT_ST_REG	Masked interrupt status	0x3FF560A4	RO
RMT_INT_ENA_REG	Interrupt enable bits	0x3FF560A8	R/W
RMT_INT_CLR_REG	Interrupt clear bits	0x3FF560AC	WO
Carrier wave duty cycle registers			
RMT_CH0CARRIER_DUTY_REG	Channel 0 duty cycle configuration register	0x3FF560B0	R/W
RMT_CH1CARRIER_DUTY_REG	Channel 1 duty cycle configuration register	0x3FF560B4	R/W
RMT_CH2CARRIER_DUTY_REG	Channel 2 duty cycle configuration register	0x3FF560B8	R/W
RMT_CH3CARRIER_DUTY_REG	Channel 3 duty cycle configuration register	0x3FF560BC	R/W
RMT_CH4CARRIER_DUTY_REG	Channel 4 duty cycle configuration register	0x3FF560C0	R/W
RMT_CH5CARRIER_DUTY_REG	Channel 5 duty cycle configuration register	0x3FF560C4	R/W
RMT_CH6CARRIER_DUTY_REG	Channel 6 duty cycle configuration register	0x3FF560C8	R/W
RMT_CH7CARRIER_DUTY_REG	Channel 7 duty cycle configuration register	0x3FF560CC	R/W
Tx event configuration registers			
RMT_CH0_TX_LIM_REG	Channel 0 Tx event configuration register	0x3FF560D0	R/W
RMT_CH1_TX_LIM_REG	Channel 1 Tx event configuration register	0x3FF560D4	R/W
RMT_CH2_TX_LIM_REG	Channel 2 Tx event configuration register	0x3FF560D8	R/W
RMT_CH3_TX_LIM_REG	Channel 3 Tx event configuration register	0x3FF560DC	R/W
RMT_CH4_TX_LIM_REG	Channel 4 Tx event configuration register	0x3FF560E0	R/W
RMT_CH5_TX_LIM_REG	Channel 5 Tx event configuration register	0x3FF560E4	R/W
RMT_CH6_TX_LIM_REG	Channel 6 Tx event configuration register	0x3FF560E8	R/W
RMT_CH7_TX_LIM_REG	Channel 7 Tx event configuration register	0x3FF560EC	R/W
Other registers			
RMT_APB_CONF_REG	RMT-wide configuration register	0x3FF560F0	R/W

6.4 Registers

Register 6.1: RMT_CH n CONF0_REG (n : 0-7) (0x0058+8* n)

(reserved)		RMT_MEM_PD		RMT_CARRIER_OUT_LV_CH n		RMT_CARRIER_EN_CH n		RMT_MEM_SIZE_CH n		RMT_IDLE_THRES_CH n		RMT_DIV_CNT_CH n	
31	30	29	28	27	24	23					8	7	0
0x0	0	1	1	0x01		0x01000				0x002			Reset

RMT_MEM_PD This bit is used power down the entire RMT RAM block (Only exists in RMT_CH0CONF0). 1: memory is powered down 0: memory is powered up (R/W)

RMT_CARRIER_OUT_LV_CH n This bit is used to configure when the carrier wave is transmitted. 1: transmit on low output level, 0: transmit on high output level. (R/W)

RMT_CARRIER_EN_CH n This is the carrier modulation enable control bit for channel n . 1: carrier modulation enabled 0: carrier modulation disabled (R/W)

RMT_MEM_SIZE_CH n This register is used to configure the amount of memory blocks allocated to channel n (R/W)

RMT_IDLE_THRES_CH n In receive mode, when no edge is detected on the input signal for longer than reg_idle_thres_ch n channel clock cycles, the receive process is finished. (R/W)

RMT_DIV_CNT_CH n This register is used to set the divider for the channel clock of channel n . (R/W)

Register 6.2: RMT_CH n CONF1_REG (n : 0-7) (0x005c+8* n)

(reserved)				RMT_IDLE_OUT_EN_CH n RMT_IDLE_OUT_LV_CH n RMT_REF_ALWAYS_ON_CH n RMT_REF_CNT_RST_CH n				RMT_RX_FILTER_THRES_CH n				RMT_RX_FILTER_EN_CH n RMT_TX_CONTI_MODE_CH n RMT_MEM_OWNER_CH n (reserved) RMT_MEM_RD_RST_CH n RMT_MEM_WR_RST_CH n RMT_RX_EN_CH n RMT_TX_START_CH n				
31	20	19	18	17	16	15	8	7	6	5	4	3	2	1	0	
0x0000							0x00F							0 0 1 0 0 0 0 0		Reset

RMT_IDLE_OUT_EN_CH n This is the output enable control bit for channel n in IDLE state. (R/W)

RMT_IDLE_OUT_LV_CH n This bit configures the output signals level for channel n in IDLE state. (R/W)

RMT_REF_ALWAYS_ON_CH n This bit is used to select the channels base clock. 1:clk_apb; 0:clk_ref. (R/W)

RMT_REF_CNT_RST_CH n Setting this bit resets the clock divider of channel n . (R/W)

RMT_RX_FILTER_THRES_CH n In receive mode, channel n ignores input pulse when the pulse width is smaller than this value, in APB clock periods. (R/W)

RMT_RX_FILTER_EN_CH n This is the receive filter enable bit for channel n . (R/W)

RMT_TX_CONTI_MODE_CH n If this bit is set, instead of going to idle when the transmission ends, the transmitter will restart transmission. This results in a repeating output signal. (R/W)

RMT_MEM_OWNER_CH n This bit marks channel n 's RAM block ownership. 1: receiver uses the RAM; 0: transmitter uses the RAM. (R/W)

RMT_MEM_RD_RST_CH n Set this bit to reset read ram address for channel n by transmitter access. (R/W)

RMT_MEM_WR_RST_CH n Set this bit to reset write ram address for channel n by receiver access. (R/W)

RMT_RX_EN_CH n Set this bit to enable receiving data on channel n . (R/W)

RMT_TX_START_CH n Set this bit to start sending data on channel n . (R/W)

Register 6.3: RMT_INT_RAW_REG (0x00a0)

<div style="display: flex; justify-content: space-between;"> <div style="writing-mode: vertical-rl; transform: rotate(180deg);">RMT_CH7_TX_THR_EVENT_INT_RAW</div> <div style="writing-mode: vertical-rl; transform: rotate(180deg);">RMT_CH6_TX_THR_EVENT_INT_RAW</div> <div style="writing-mode: vertical-rl; transform: rotate(180deg);">RMT_CH5_TX_THR_EVENT_INT_RAW</div> <div style="writing-mode: vertical-rl; transform: rotate(180deg);">RMT_CH4_TX_THR_EVENT_INT_RAW</div> <div style="writing-mode: vertical-rl; transform: rotate(180deg);">RMT_CH3_TX_THR_EVENT_INT_RAW</div> <div style="writing-mode: vertical-rl; transform: rotate(180deg);">RMT_CH2_TX_THR_EVENT_INT_RAW</div> <div style="writing-mode: vertical-rl; transform: rotate(180deg);">RMT_CH1_TX_THR_EVENT_INT_RAW</div> <div style="writing-mode: vertical-rl; transform: rotate(180deg);">RMT_CH0_TX_THR_EVENT_INT_RAW</div> <div style="writing-mode: vertical-rl; transform: rotate(180deg);">RMT_CH7_ERR_INT_RAW</div> <div style="writing-mode: vertical-rl; transform: rotate(180deg);">RMT_CH6_ERR_INT_RAW</div> <div style="writing-mode: vertical-rl; transform: rotate(180deg);">RMT_CH5_ERR_INT_RAW</div> <div style="writing-mode: vertical-rl; transform: rotate(180deg);">RMT_CH4_ERR_INT_RAW</div> <div style="writing-mode: vertical-rl; transform: rotate(180deg);">RMT_CH3_ERR_INT_RAW</div> <div style="writing-mode: vertical-rl; transform: rotate(180deg);">RMT_CH2_ERR_INT_RAW</div> <div style="writing-mode: vertical-rl; transform: rotate(180deg);">RMT_CH1_ERR_INT_RAW</div> <div style="writing-mode: vertical-rl; transform: rotate(180deg);">RMT_CH0_ERR_INT_RAW</div> <div style="writing-mode: vertical-rl; transform: rotate(180deg);">RMT_CH7_RX_END_INT_RAW</div> <div style="writing-mode: vertical-rl; transform: rotate(180deg);">RMT_CH6_RX_END_INT_RAW</div> <div style="writing-mode: vertical-rl; transform: rotate(180deg);">RMT_CH5_RX_END_INT_RAW</div> <div style="writing-mode: vertical-rl; transform: rotate(180deg);">RMT_CH4_RX_END_INT_RAW</div> <div style="writing-mode: vertical-rl; transform: rotate(180deg);">RMT_CH3_RX_END_INT_RAW</div> <div style="writing-mode: vertical-rl; transform: rotate(180deg);">RMT_CH2_RX_END_INT_RAW</div> <div style="writing-mode: vertical-rl; transform: rotate(180deg);">RMT_CH1_RX_END_INT_RAW</div> <div style="writing-mode: vertical-rl; transform: rotate(180deg);">RMT_CH0_RX_END_INT_RAW</div> <div style="writing-mode: vertical-rl; transform: rotate(180deg);">RMT_CH7_TX_END_INT_RAW</div> <div style="writing-mode: vertical-rl; transform: rotate(180deg);">RMT_CH6_TX_END_INT_RAW</div> <div style="writing-mode: vertical-rl; transform: rotate(180deg);">RMT_CH5_TX_END_INT_RAW</div> <div style="writing-mode: vertical-rl; transform: rotate(180deg);">RMT_CH4_TX_END_INT_RAW</div> <div style="writing-mode: vertical-rl; transform: rotate(180deg);">RMT_CH3_TX_END_INT_RAW</div> <div style="writing-mode: vertical-rl; transform: rotate(180deg);">RMT_CH2_TX_END_INT_RAW</div> <div style="writing-mode: vertical-rl; transform: rotate(180deg);">RMT_CH1_TX_END_INT_RAW</div> <div style="writing-mode: vertical-rl; transform: rotate(180deg);">RMT_CH0_TX_END_INT_RAW</div> </div>																																		
31	30	29	28	27	26	25	24	23	22	21	20	19	18	17	16	15	14	13	12	11	10	9	8	7	6	5	4	3	2	1	0			
0	0	0	0	0	0	0	0	0	0	0	0	0	0	0	0	0	0	0	0	0	0	0	0	0	0	0	0	0	0	0	0	0	0	Reset

RMT_CH_nTX_THR_EVENT_INT_RAW The raw interrupt status bit for the [RMT_CH_nTX_THR_EVENT_INT](#) interrupt. (RO)

RMT_CH_nERR_INT_RAW The raw interrupt status bit for the [RMT_CH_nERR_INT](#) interrupt. (RO)

RMT_CH_nRX_END_INT_RAW The raw interrupt status bit for the [RMT_CH_nRX_END_INT](#) interrupt. (RO)

RMT_CH_nTX_END_INT_RAW The raw interrupt status bit for the [RMT_CH_nTX_END_INT](#) interrupt. (RO)

Register 6.4: RMT_INT_ST_REG (0x00a4)

<div style="display: flex; justify-content: space-between;"> <div style="writing-mode: vertical-rl; transform: rotate(180deg);">RMT_CH7_TX_THR_EVENT_INT_ST</div> <div style="writing-mode: vertical-rl; transform: rotate(180deg);">RMT_CH6_TX_THR_EVENT_INT_ST</div> <div style="writing-mode: vertical-rl; transform: rotate(180deg);">RMT_CH5_TX_THR_EVENT_INT_ST</div> <div style="writing-mode: vertical-rl; transform: rotate(180deg);">RMT_CH4_TX_THR_EVENT_INT_ST</div> <div style="writing-mode: vertical-rl; transform: rotate(180deg);">RMT_CH3_TX_THR_EVENT_INT_ST</div> <div style="writing-mode: vertical-rl; transform: rotate(180deg);">RMT_CH2_TX_THR_EVENT_INT_ST</div> <div style="writing-mode: vertical-rl; transform: rotate(180deg);">RMT_CH1_TX_THR_EVENT_INT_ST</div> <div style="writing-mode: vertical-rl; transform: rotate(180deg);">RMT_CH0_TX_THR_EVENT_INT_ST</div> <div style="writing-mode: vertical-rl; transform: rotate(180deg);">RMT_CH7_ERR_INT_ST</div> <div style="writing-mode: vertical-rl; transform: rotate(180deg);">RMT_CH6_ERR_INT_ST</div> <div style="writing-mode: vertical-rl; transform: rotate(180deg);">RMT_CH5_ERR_INT_ST</div> <div style="writing-mode: vertical-rl; transform: rotate(180deg);">RMT_CH4_ERR_INT_ST</div> <div style="writing-mode: vertical-rl; transform: rotate(180deg);">RMT_CH3_ERR_INT_ST</div> <div style="writing-mode: vertical-rl; transform: rotate(180deg);">RMT_CH2_ERR_INT_ST</div> <div style="writing-mode: vertical-rl; transform: rotate(180deg);">RMT_CH1_ERR_INT_ST</div> <div style="writing-mode: vertical-rl; transform: rotate(180deg);">RMT_CH0_ERR_INT_ST</div> <div style="writing-mode: vertical-rl; transform: rotate(180deg);">RMT_CH7_RX_END_INT_ST</div> <div style="writing-mode: vertical-rl; transform: rotate(180deg);">RMT_CH6_RX_END_INT_ST</div> <div style="writing-mode: vertical-rl; transform: rotate(180deg);">RMT_CH5_RX_END_INT_ST</div> <div style="writing-mode: vertical-rl; transform: rotate(180deg);">RMT_CH4_RX_END_INT_ST</div> <div style="writing-mode: vertical-rl; transform: rotate(180deg);">RMT_CH3_RX_END_INT_ST</div> <div style="writing-mode: vertical-rl; transform: rotate(180deg);">RMT_CH2_RX_END_INT_ST</div> <div style="writing-mode: vertical-rl; transform: rotate(180deg);">RMT_CH1_RX_END_INT_ST</div> <div style="writing-mode: vertical-rl; transform: rotate(180deg);">RMT_CH0_RX_END_INT_ST</div> <div style="writing-mode: vertical-rl; transform: rotate(180deg);">RMT_CH7_TX_END_INT_ST</div> <div style="writing-mode: vertical-rl; transform: rotate(180deg);">RMT_CH6_TX_END_INT_ST</div> <div style="writing-mode: vertical-rl; transform: rotate(180deg);">RMT_CH5_TX_END_INT_ST</div> <div style="writing-mode: vertical-rl; transform: rotate(180deg);">RMT_CH4_TX_END_INT_ST</div> <div style="writing-mode: vertical-rl; transform: rotate(180deg);">RMT_CH3_TX_END_INT_ST</div> <div style="writing-mode: vertical-rl; transform: rotate(180deg);">RMT_CH2_TX_END_INT_ST</div> <div style="writing-mode: vertical-rl; transform: rotate(180deg);">RMT_CH1_TX_END_INT_ST</div> <div style="writing-mode: vertical-rl; transform: rotate(180deg);">RMT_CH0_TX_END_INT_ST</div> </div>																																	
31	30	29	28	27	26	25	24	23	22	21	20	19	18	17	16	15	14	13	12	11	10	9	8	7	6	5	4	3	2	1	0		
0	0	0	0	0	0	0	0	0	0	0	0	0	0	0	0	0	0	0	0	0	0	0	0	0	0	0	0	0	0	0	0	0	Reset

RMT_CH_nTX_THR_EVENT_INT_ST The masked interrupt status bit for the [RMT_CH_nTX_THR_EVENT_INT](#) interrupt. (RO)

RMT_CH_nERR_INT_ST The masked interrupt status bit for the [RMT_CH_nERR_INT](#) interrupt. (RO)

RMT_CH_nRX_END_INT_ST The masked interrupt status bit for the [RMT_CH_nRX_END_INT](#) interrupt. (RO)

RMT_CH_nTX_END_INT_ST The masked interrupt status bit for the [RMT_CH_nTX_END_INT](#) interrupt. (RO)

Register 6.5: RMT_INT_ENA_REG (0x00a8)

<div style="display: flex; justify-content: space-between;"> <div style="writing-mode: vertical-rl; transform: rotate(180deg);">RMT_CH7_TX_THR_EVENT_INT_ENA</div> <div style="writing-mode: vertical-rl; transform: rotate(180deg);">RMT_CH6_TX_THR_EVENT_INT_ENA</div> <div style="writing-mode: vertical-rl; transform: rotate(180deg);">RMT_CH5_TX_THR_EVENT_INT_ENA</div> <div style="writing-mode: vertical-rl; transform: rotate(180deg);">RMT_CH4_TX_THR_EVENT_INT_ENA</div> <div style="writing-mode: vertical-rl; transform: rotate(180deg);">RMT_CH3_TX_THR_EVENT_INT_ENA</div> <div style="writing-mode: vertical-rl; transform: rotate(180deg);">RMT_CH2_TX_THR_EVENT_INT_ENA</div> <div style="writing-mode: vertical-rl; transform: rotate(180deg);">RMT_CH1_TX_THR_EVENT_INT_ENA</div> <div style="writing-mode: vertical-rl; transform: rotate(180deg);">RMT_CH0_TX_THR_EVENT_INT_ENA</div> <div style="writing-mode: vertical-rl; transform: rotate(180deg);">RMT_CH7_ERR_INT_ENA</div> <div style="writing-mode: vertical-rl; transform: rotate(180deg);">RMT_CH6_ERR_INT_ENA</div> <div style="writing-mode: vertical-rl; transform: rotate(180deg);">RMT_CH5_ERR_INT_ENA</div> <div style="writing-mode: vertical-rl; transform: rotate(180deg);">RMT_CH4_ERR_INT_ENA</div> <div style="writing-mode: vertical-rl; transform: rotate(180deg);">RMT_CH3_ERR_INT_ENA</div> <div style="writing-mode: vertical-rl; transform: rotate(180deg);">RMT_CH2_ERR_INT_ENA</div> <div style="writing-mode: vertical-rl; transform: rotate(180deg);">RMT_CH1_ERR_INT_ENA</div> <div style="writing-mode: vertical-rl; transform: rotate(180deg);">RMT_CH0_ERR_INT_ENA</div> <div style="writing-mode: vertical-rl; transform: rotate(180deg);">RMT_CH7_RX_END_INT_ENA</div> <div style="writing-mode: vertical-rl; transform: rotate(180deg);">RMT_CH6_RX_END_INT_ENA</div> <div style="writing-mode: vertical-rl; transform: rotate(180deg);">RMT_CH5_RX_END_INT_ENA</div> <div style="writing-mode: vertical-rl; transform: rotate(180deg);">RMT_CH4_RX_END_INT_ENA</div> <div style="writing-mode: vertical-rl; transform: rotate(180deg);">RMT_CH3_RX_END_INT_ENA</div> <div style="writing-mode: vertical-rl; transform: rotate(180deg);">RMT_CH2_RX_END_INT_ENA</div> <div style="writing-mode: vertical-rl; transform: rotate(180deg);">RMT_CH1_RX_END_INT_ENA</div> <div style="writing-mode: vertical-rl; transform: rotate(180deg);">RMT_CH0_RX_END_INT_ENA</div> <div style="writing-mode: vertical-rl; transform: rotate(180deg);">RMT_CH7_TX_END_INT_ENA</div> <div style="writing-mode: vertical-rl; transform: rotate(180deg);">RMT_CH6_TX_END_INT_ENA</div> <div style="writing-mode: vertical-rl; transform: rotate(180deg);">RMT_CH5_TX_END_INT_ENA</div> <div style="writing-mode: vertical-rl; transform: rotate(180deg);">RMT_CH4_TX_END_INT_ENA</div> <div style="writing-mode: vertical-rl; transform: rotate(180deg);">RMT_CH3_TX_END_INT_ENA</div> <div style="writing-mode: vertical-rl; transform: rotate(180deg);">RMT_CH2_TX_END_INT_ENA</div> <div style="writing-mode: vertical-rl; transform: rotate(180deg);">RMT_CH1_TX_END_INT_ENA</div> <div style="writing-mode: vertical-rl; transform: rotate(180deg);">RMT_CH0_TX_END_INT_ENA</div> </div>																																		
31	30	29	28	27	26	25	24	23	22	21	20	19	18	17	16	15	14	13	12	11	10	9	8	7	6	5	4	3	2	1	0			
0	0	0	0	0	0	0	0	0	0	0	0	0	0	0	0	0	0	0	0	0	0	0	0	0	0	0	0	0	0	0	0	0	0	Reset

RMT_CH_nTX_THR_EVENT_INT_ENA The interrupt enable bit for the [RMT_CH_nTX_THR_EVENT_INT](#) interrupt. (R/W)

RMT_CH_nERR_INT_ENA The interrupt enable bit for the [RMT_CH_nERROR_INT](#) interrupt. (R/W)

RMT_CH_nRX_END_INT_ENA The interrupt enable bit for the [RMT_CH_nRX_END_INT](#) interrupt. (R/W)

RMT_CH_nTX_END_INT_ENA The interrupt enable bit for the [RMT_CH_nTX_END_INT](#) interrupt. (R/W)

Register 6.6: RMT_INT_CLR_REG (0x00ac)

<div style="display: flex; justify-content: space-between;"> <div style="writing-mode: vertical-rl; transform: rotate(180deg);">RMT_CH7_TX_THR_EVENT_INT_CLR</div> <div style="writing-mode: vertical-rl; transform: rotate(180deg);">RMT_CH6_TX_THR_EVENT_INT_CLR</div> <div style="writing-mode: vertical-rl; transform: rotate(180deg);">RMT_CH5_TX_THR_EVENT_INT_CLR</div> <div style="writing-mode: vertical-rl; transform: rotate(180deg);">RMT_CH4_TX_THR_EVENT_INT_CLR</div> <div style="writing-mode: vertical-rl; transform: rotate(180deg);">RMT_CH3_TX_THR_EVENT_INT_CLR</div> <div style="writing-mode: vertical-rl; transform: rotate(180deg);">RMT_CH2_TX_THR_EVENT_INT_CLR</div> <div style="writing-mode: vertical-rl; transform: rotate(180deg);">RMT_CH1_TX_THR_EVENT_INT_CLR</div> <div style="writing-mode: vertical-rl; transform: rotate(180deg);">RMT_CH0_TX_THR_EVENT_INT_CLR</div> <div style="writing-mode: vertical-rl; transform: rotate(180deg);">RMT_CH7_ERR_INT_CLR</div> <div style="writing-mode: vertical-rl; transform: rotate(180deg);">RMT_CH6_ERR_INT_CLR</div> <div style="writing-mode: vertical-rl; transform: rotate(180deg);">RMT_CH5_ERR_INT_CLR</div> <div style="writing-mode: vertical-rl; transform: rotate(180deg);">RMT_CH4_ERR_INT_CLR</div> <div style="writing-mode: vertical-rl; transform: rotate(180deg);">RMT_CH3_ERR_INT_CLR</div> <div style="writing-mode: vertical-rl; transform: rotate(180deg);">RMT_CH2_ERR_INT_CLR</div> <div style="writing-mode: vertical-rl; transform: rotate(180deg);">RMT_CH1_ERR_INT_CLR</div> <div style="writing-mode: vertical-rl; transform: rotate(180deg);">RMT_CH0_ERR_INT_CLR</div> <div style="writing-mode: vertical-rl; transform: rotate(180deg);">RMT_CH7_RX_END_INT_CLR</div> <div style="writing-mode: vertical-rl; transform: rotate(180deg);">RMT_CH6_RX_END_INT_CLR</div> <div style="writing-mode: vertical-rl; transform: rotate(180deg);">RMT_CH5_RX_END_INT_CLR</div> <div style="writing-mode: vertical-rl; transform: rotate(180deg);">RMT_CH4_RX_END_INT_CLR</div> <div style="writing-mode: vertical-rl; transform: rotate(180deg);">RMT_CH3_RX_END_INT_CLR</div> <div style="writing-mode: vertical-rl; transform: rotate(180deg);">RMT_CH2_RX_END_INT_CLR</div> <div style="writing-mode: vertical-rl; transform: rotate(180deg);">RMT_CH1_RX_END_INT_CLR</div> <div style="writing-mode: vertical-rl; transform: rotate(180deg);">RMT_CH0_RX_END_INT_CLR</div> <div style="writing-mode: vertical-rl; transform: rotate(180deg);">RMT_CH7_TX_END_INT_CLR</div> <div style="writing-mode: vertical-rl; transform: rotate(180deg);">RMT_CH6_TX_END_INT_CLR</div> <div style="writing-mode: vertical-rl; transform: rotate(180deg);">RMT_CH5_TX_END_INT_CLR</div> <div style="writing-mode: vertical-rl; transform: rotate(180deg);">RMT_CH4_TX_END_INT_CLR</div> <div style="writing-mode: vertical-rl; transform: rotate(180deg);">RMT_CH3_TX_END_INT_CLR</div> <div style="writing-mode: vertical-rl; transform: rotate(180deg);">RMT_CH2_TX_END_INT_CLR</div> <div style="writing-mode: vertical-rl; transform: rotate(180deg);">RMT_CH1_TX_END_INT_CLR</div> <div style="writing-mode: vertical-rl; transform: rotate(180deg);">RMT_CH0_TX_END_INT_CLR</div> </div>																																	
31	30	29	28	27	26	25	24	23	22	21	20	19	18	17	16	15	14	13	12	11	10	9	8	7	6	5	4	3	2	1	0		
0	0	0	0	0	0	0	0	0	0	0	0	0	0	0	0	0	0	0	0	0	0	0	0	0	0	0	0	0	0	0	0	0	Reset

RMT_CH_nTX_THR_EVENT_INT_CLR Set this bit to clear the [RMT_CH_nTX_THR_EVENT_INT](#) interrupt. (WO)

RMT_CH_nERR_INT_CLR Set this bit to clear the [RMT_CH_nERRINT](#) interrupt. (WO)

RMT_CH_nRX_END_INT_CLR Set this bit to clear the [RMT_CH_nRX_END_INT](#) interrupt. (WO)

RMT_CH_nTX_END_INT_CLR Set this bit to clear the [RMT_CH_nTX_END_INT](#) interrupt. (WO)

Register 6.7: RMT_CH n CARRIER_DUTY_REG (n : 0-7) (0x00cc+4* n)

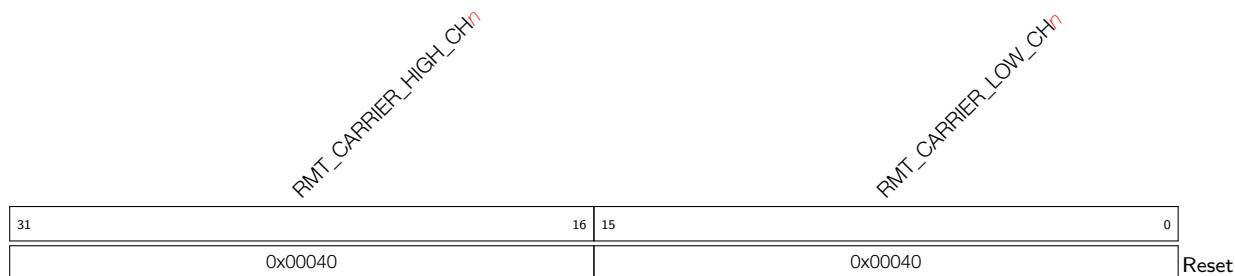

RMT_CARRIER_HIGH_CH n This field is used to configure the carrier wave high level duration (in channel clock periods) for channel n . (R/W)

RMT_CARRIER_LOW_CH n This field is used to configure the carrier wave low level duration (in channel clock periods) for channel n . (R/W)

Register 6.8: RMT_CH n _TX_LIM_REG (n : 0-7) (0x00ec+4* n)

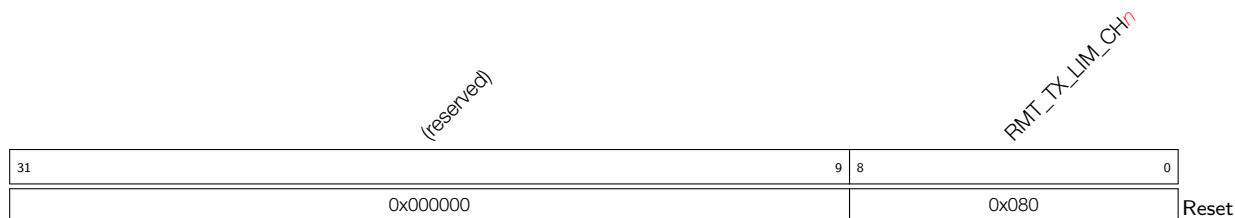

RMT_TX_LIM_CH n When channel n sends more entries than specified here, it produces a TX_THR_EVENT interrupt. (R/W)

Register 6.9: RMT_APB_CONF_REG (0x00f0)

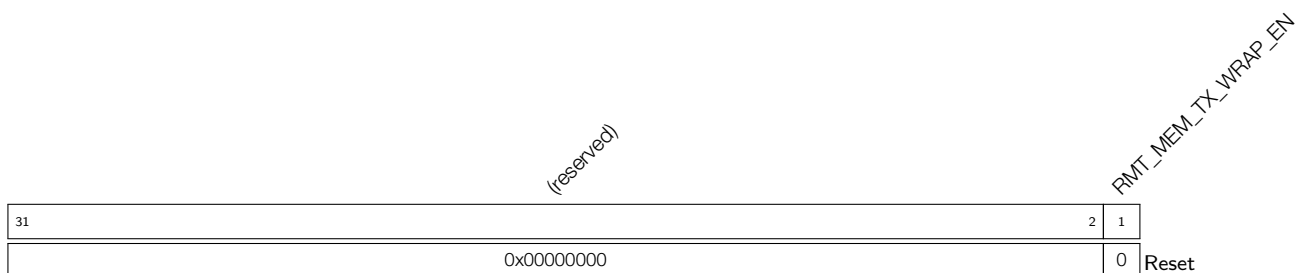

RMT_MEM_TX_WRAP_EN bit enables wraparound mode: when the transmitter of a channel has reached the end of its memory block, it will resume sending at the start of its memory region. (R/W)

7. PULSE_CNT

7.1 Introduction

The pulse counter module is designed to count the number of rising and/or falling edges of an input signal. Each pulse counter unit has a 16-bit signed counter register and two channels that can be configured to either increment or decrement the counter. Each channel has a signal input that accepts signal edges to be detected, as well as a control input that can be used to enable or disable the signal input. The inputs have optional filters that can be used to discard unwanted glitches in the signal.

The pulse counter has eight independent units, referred to as PULSE_CNT_0n.

7.2 Functional Description

7.2.1 Architecture

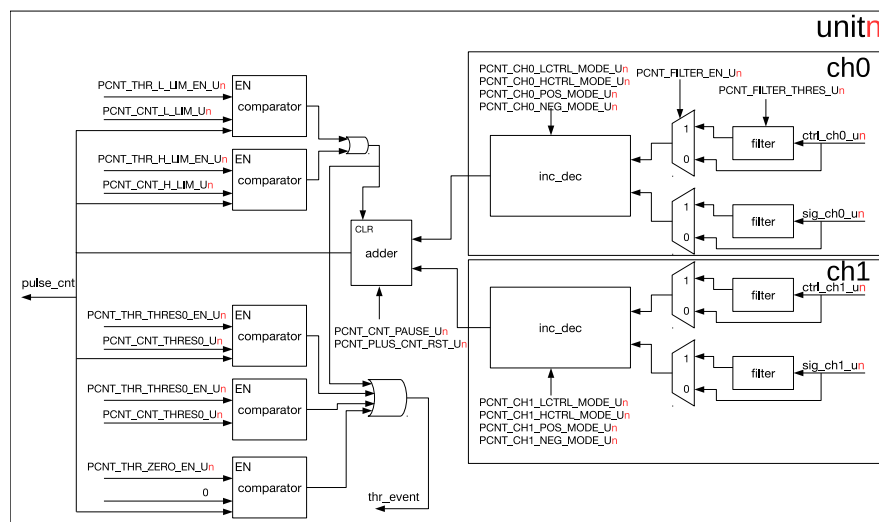

Figure 16: PULSE_CNT Architecture

The architecture of a pulse counter unit is illustrated in Figure 16. Each unit has two channels: ch0 and ch1, which are functionally equivalent. Each channel has a signal input as well as a control input which can both be connected to I/O pads. The counting behaviour on both positive edge as well as negative edge can be configured separately to increase, decrease or do nothing to the counter value. Separately, for both control signal levels, the hardware can be configured to modify the edge action: invert it, disable it or do nothing. The counter itself is a 16-bit signed up/down counter. Its value can be read by software directly, but is also monitored by a set of comparators which can trigger an interrupt.

7.2.2 Counter Channel Inputs

As stated before, the two inputs of a channel can affect the pulse counter in various ways. The specifics of this behaviour is set by LCTRL_MODE and HCTRL_MODE for the case when the control signal is low or high, respectively, and POS_MODE and NEG_MODE for positive and negative edges of the input signal. Setting POS_MODE and NEG_MODE to 1 will increase the counter when an edge is detected, setting them to 2 will decrease the counter and setting any other value will make the edge not have any effect on the counter. LCTR_MODE and HCTR_MODE modify this behaviour as such when the control input has the corresponding low

or high value: 0 does not modify the NEG_MODE and POS_MODE behaviour, 1 inverts it (setting POS_MODE/NEG_MODE to increase the counter will now decrease the counter and vice versa) and any other value disables counter effects for that signal level.

To summarize, a few examples have been considered. In this table, the effect on the counter for a rising edge is shown for both a low and a high control signal and various configuration options. For clarity, a short description in brackets is added after the values. Note: x denotes 'don't care'.

POS_MODE	LCTRL_MODE	HCTRL_MODE	sig l→h when ctrl=0	sig l→h when ctrl=1
1 (inc)	0 (-)	0 (-)	Inc ctr	Inc ctr
2 (dec)	0 (-)	0 (-)	Dec ctr	Dec ctr
0 (-)	x	x	No action	No action
1 (inc)	0 (-)	1 (inv)	Inc ctr	Dec ctr
1 (inc)	1 (inv)	0 (-)	Dec ctr	Inc ctr
2 (dec)	0 (-)	1 (inv)	Dec ctr	Inc ctr
1 (inc)	0 (-)	2 (dis)	Inc ctr	No action
1 (inc)	2 (dis)	0 (-)	No action	Inc ctr

This table is also valid for negative edges (sig h→l) on substituting NEG_MODE for POS_MODE.

Each pulse counter unit also features a filter on each of the four inputs, adding the option to ignore short glitches in the signals. If a PCNT_FILTER_EN_Un can be set to filter the four input signals of the unit. If this filter is enabled, any pulses shorter than REG_FILTER_THRES_Un number of APB_CLK clock cycles will be filtered out and will have no effect on the counter. With the filter disabled, in theory infinitely small glitches could possibly trigger pulse counter action. However, in practice the signal inputs are sampled on APB_CLK edges and even with the filter disabled, pulse widths lasting shorter than one APB_CLK cycle may be missed.

Apart from the input channels, software also has some control over the counter. In particular, the counter value can be frozen to the current value by configuring PCNT_CNT_PAUSE_Un. It can also be reset to zero by configuring PCNT_PULSE_CNT_RST_Un.

7.2.3 Watchpoints

The pulse counters have 5 watchpoints that share one interrupt. Interrupt generation can be enabled or disabled for each individual watchpoint. The watchpoints are:

- Maximum count value: Triggered when $PULSE_CNT \geq PCNT_THR_H_LIM_Un$. Additionally, this will reset the counter to zero.
- Minimum count value: Triggered when $PULSE_CNT \leq PCNT_THR_L_LIM_Un$. Additionally, this will reset the counter to zero. This is most useful when $PCNT_THR_L_LIM_Un$ is set to a negative number.
- Two threshold values: Triggered when $PULSE_CNT = PCNT_THR_THRES0_Un$ or $PCNT_THR_THRES1_Un$.
- Zero: Triggered when $PULSE_CNT = 0$.

7.2.4 Examples

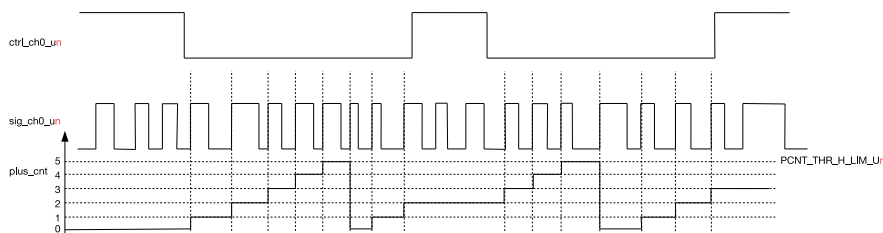

Figure 17: PULSE_CNT Upcounting Diagram

Figure 17 shows channel 0 being used as an up-counter. The configuration of channel 0 is shown below.

- $CNT_CH0_POS_MODE_Un = 1$: increase counter on the rising edge of sig_ch0_un .
- $PCNT_CH0_NEG_MODE_Un = 0$: no counting on the falling edge of sig_ch0_un .
- $PCNT_CH0_LCTRL_MODE_Un = 0$: Do not modify counter mode when sig_ch0_un is low.
- $PCNT_CH0_HCTRL_MODE_Un = 2$: Do not allow counter increments/decrements when sig_ch0_un is high.
- $PCNT_THR_H_LIM_Un = 5$: PULSE_CNT resets to 0 when the count value increases to 5.

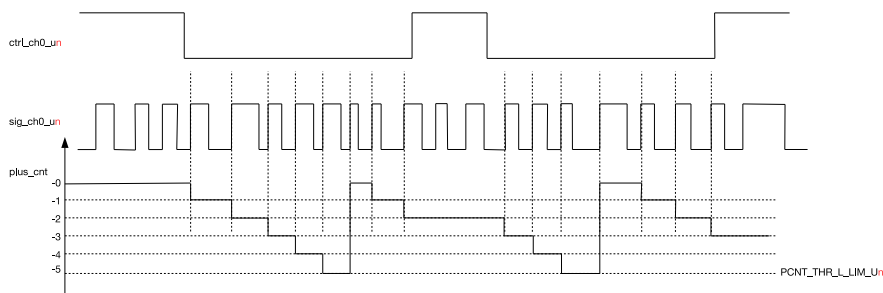

Figure 18: PULSE_CNT Downcounting Diagram

Figure 18 shows channel 0 decrementing the counter. The configuration of channel 0 differs from that in Figure 17 in the following two aspects:

- $PCNT_CH0_LCTRL_MODE_Un = 1$: invert counter mode when $ctrl_ch0_un$ is at low level, so it will decrease instead of increase the counter.
- $PCNT_THR_H_LIM_Un = -5$: PULSE_CNT resets to 0 when the count value decreases to -5.

7.2.5 Interrupts

$PCNT_CNT_THR_EVENT_Un_INT$: This interrupt gets triggered when one of the five channel comparators detects a match.

7.3 Register Summary

Name	Description	Address	Access
Configuration registers			
PCNT_U0_CONF0_REG	Configuration register 0 for unit 0	0x3FF57000	R/W

Name	Description	Address	Access
PCNT_U1_CONF0_REG	Configuration register 0 for unit 1	0x3FF5700C	R/W
PCNT_U2_CONF0_REG	Configuration register 0 for unit 2	0x3FF57018	R/W
PCNT_U3_CONF0_REG	Configuration register 0 for unit 3	0x3FF57024	R/W
PCNT_U4_CONF0_REG	Configuration register 0 for unit 4	0x3FF57030	R/W
PCNT_U5_CONF0_REG	Configuration register 0 for unit 5	0x3FF5703C	R/W
PCNT_U6_CONF0_REG	Configuration register 0 for unit 6	0x3FF57048	R/W
PCNT_U7_CONF0_REG	Configuration register 0 for unit 7	0x3FF57054	R/W
PCNT_U0_CONF1_REG	Configuration register 1 for unit 0	0x3FF57004	R/W
PCNT_U1_CONF1_REG	Configuration register 1 for unit 1	0x3FF57010	R/W
PCNT_U2_CONF1_REG	Configuration register 1 for unit 2	0x3FF5701C	R/W
PCNT_U3_CONF1_REG	Configuration register 1 for unit 3	0x3FF57028	R/W
PCNT_U4_CONF1_REG	Configuration register 1 for unit 4	0x3FF57034	R/W
PCNT_U5_CONF1_REG	Configuration register 1 for unit 5	0x3FF57040	R/W
PCNT_U6_CONF1_REG	Configuration register 1 for unit 6	0x3FF5704C	R/W
PCNT_U7_CONF1_REG	Configuration register 1 for unit 7	0x3FF57058	R/W
PCNT_U0_CONF2_REG	Configuration register 2 for unit 0	0x3FF57008	R/W
PCNT_U1_CONF2_REG	Configuration register 2 for unit 1	0x3FF57014	R/W
PCNT_U2_CONF2_REG	Configuration register 2 for unit 2	0x3FF57020	R/W
PCNT_U3_CONF2_REG	Configuration register 2 for unit 3	0x3FF5702C	R/W
PCNT_U4_CONF2_REG	Configuration register 2 for unit 4	0x3FF57038	R/W
PCNT_U5_CONF2_REG	Configuration register 2 for unit 5	0x3FF57044	R/W
PCNT_U6_CONF2_REG	Configuration register 2 for unit 6	0x3FF57050	R/W
PCNT_U7_CONF2_REG	Configuration register 2 for unit 7	0x3FF5705C	R/W
Counter values			
PCNT_U0_CNT_REG	Counter value for unit 0	0x3FF57060	RO
PCNT_U1_CNT_REG	Counter value for unit 1	0x3FF57064	RO
PCNT_U2_CNT_REG	Counter value for unit 2	0x3FF57068	RO
PCNT_U3_CNT_REG	Counter value for unit 3	0x3FF5706C	RO
PCNT_U4_CNT_REG	Counter value for unit 4	0x3FF57070	RO
PCNT_U5_CNT_REG	Counter value for unit 5	0x3FF57074	RO
PCNT_U6_CNT_REG	Counter value for unit 6	0x3FF57078	RO
PCNT_U7_CNT_REG	Counter value for unit 7	0x3FF5707C	RO
Control registers			
PCNT_CTRL_REG	Control register for all counters	0x3FF570B0	R/W
Interrupt registers			
PCNT_INT_RAW_REG	Raw interrupt status	0x3FF57080	RO
PCNT_INT_ST_REG	Masked interrupt status	0x3FF57084	RO
PCNT_INT_ENA_REG	Interrupt enable bits	0x3FF57088	R/W
PCNT_INT_CLR_REG	Interrupt clear bits	0x3FF5708C	WO

7.4 Registers

Register 7.1: PCNT_U_n_CONF0_REG (n: 0-7) (0x0+0x0C*n)

PCNT_CH1_LCTRL_MODE_U _n										PCNT_CH1_HCTRL_MODE_U _n										PCNT_CH1_POS_MODE_U _n										PCNT_CH1_NEG_MODE_U _n										PCNT_CH0_LCTRL_MODE_U _n										PCNT_CH0_HCTRL_MODE_U _n										PCNT_CH0_POS_MODE_U _n										PCNT_CH0_NEG_MODE_U _n										PCNT_THR_THRES1_EN_U _n										PCNT_THR_THRES0_EN_U _n										PCNT_THR_L_LIM_EN_U _n										PCNT_THR_H_LIM_EN_U _n										PCNT_THR_ZERO_EN_U _n										PCNT_FILTER_EN_U _n										PCNT_FILTER_THRES_U _n									
31	30	29	28	27	26	25	24	23	22	21	20	19	18	17	16	15	14	13	12	11	10	9											0																																																																																																																				
0	0	0	0	0	0	0	0	0	0	0	0	0	0	0	0	0	0	1	1	1	1	0x010										0																																																																																																																					

Reset

PCNT_CH1_LCTRL_MODE_U_n This register configures how the CH1_POS_MODE/CH1_NEG_MODE settings will be modified when the control signal is low. (R/W) 0: No modification; 1: Invert behaviour (increase -> decrease, decrease -> increase); 2, 3: Inhibit counter modification

PCNT_CH1_HCTRL_MODE_U_n This register configures how the CH1_POS_MODE/CH1_NEG_MODE settings will be modified when the control signal is low. (R/W) 0: No modification; 1: Invert behaviour (increase -> decrease, decrease -> increase); 2, 3: Inhibit counter modification

PCNT_CH1_POS_MODE_U_n This register sets the behaviour when the signal input of channel 1 detects a positive edge. (R/W) 1: Increment the counter; 2: Decrement the counter; 0, 3: No effect on counter

PCNT_CH1_NEG_MODE_U_n This register sets the behaviour when the signal input of channel 1 detects a negative edge. (R/W) 1: Increment the counter; 2: Decrement the counter; 0, 3: No effect on counter

PCNT_CH0_LCTRL_MODE_U_n This register configures how the CH0_POS_MODE/CH0_NEG_MODE settings will be modified when the control signal is low. (R/W) 0: No modification; 1: Invert behaviour (increase -> decrease, decrease -> increase); 2, 3: Inhibit counter modification

PCNT_CH0_HCTRL_MODE_U_n This register configures how the CH0_POS_MODE/CH0_NEG_MODE settings will be modified when the control signal is low. (R/W) 0: No modification; 1: Invert behaviour (increase -> decrease, decrease -> increase); 2, 3: Inhibit counter modification

PCNT_CH0_POS_MODE_U_n This register sets the behaviour when the signal input of channel 0 detects a positive edge. (R/W) 1: Increase the counter; 2: Decrease the counter; 0, 3: No effect on counter

PCNT_CH0_NEG_MODE_U_n This register sets the behaviour when the signal input of channel 0 detects a negative edge. (R/W) 1: Increase the counter; 2: Decrease the counter; 0, 3: No effect on counter

PCNT_THR_THRES1_EN_U_n This is the enable bit for unit *n*'s thres1 comparator. (R/W)

PCNT_THR_THRES0_EN_U_n This is the enable bit for unit *n*'s thres0 comparator. (R/W)

PCNT_THR_L_LIM_EN_U_n This is the enable bit for unit *n*'s thr_l_lim comparator. (R/W)

PCNT_THR_H_LIM_EN_U_n This is the enable bit for unit *n*'s thr_h_lim comparator. (R/W)

PCNT_THR_ZERO_EN_U_n This is the enable bit for unit *n*'s zero comparator. (R/W)

PCNT_FILTER_EN_U_n This is the enable bit for unit *n*'s input filter. (R/W)

PCNT_FILTER_THRES_U_n This sets the maximum threshold, in APB_CLK cycles, for the filter. Any pulses lasting shorter than this will be ignored when the filter is enabled. (R/W)

Register 7.2: PCNT_UN_CONF1_REG ($n: 0-7$) ($0x4+0x0C*n$)

<i>PCNT_CNT_THRES1_Un</i>																<i>PCNT_CNT_THRES0_Un</i>																	
31																16	15																0
0x000																0x000																Reset	

PCNT_CNT_THRES1_Un This register is used to configure the thres1 value for unit n . (R/W)

PCNT_CNT_THRES0_Un This register is used to configure the thres0 value for unit n . (R/W)

Register 7.3: PCNT_UN_CONF2_REG ($n: 0-7$) ($0x8+0x0C*n$)

<i>PCNT_CNT_L_LIM_Un</i>																<i>PCNT_CNT_H_LIM_Un</i>																	
31																16	15																0
0x000																0x000																Reset	

PCNT_CNT_L_LIM_Un This register is used to configure the thr_l_lim value for unit n . (R/W)

PCNT_CNT_H_LIM_Un This register is used to configure the thr_h_lim value for unit n . (R/W)

Register 7.4: PCNT_UN_CNT_REG ($n: 0-7$) ($0x28+0x0C*n$)

<i>(reserved)</i>																<i>PCNT_PLUS_CNT_Un</i>																	
31																16	15																0
0 0 0 0 0 0 0 0 0 0 0 0 0 0 0 0																0x00000																Reset	

PCNT_PLUS_CNT_Un This register stores the current pulse count value for unit n . (RO)

Register 7.5: PCNT_INT_RAW_REG (0x0080)

(reserved)								PCNT_CNT_THR_EVENT_U7_INT_RAW PCNT_CNT_THR_EVENT_U6_INT_RAW PCNT_CNT_THR_EVENT_U5_INT_RAW PCNT_CNT_THR_EVENT_U4_INT_RAW PCNT_CNT_THR_EVENT_U3_INT_RAW PCNT_CNT_THR_EVENT_U2_INT_RAW PCNT_CNT_THR_EVENT_U1_INT_RAW PCNT_CNT_THR_EVENT_U0_INT_RAW									
31								8	7	6	5	4	3	2	1	0	
0x0000000								0	0	0	0	0	0	0	0	0	0
Reset																	

PCNT_CNT_THR_EVENT_U n _INT_RAW The raw interrupt status bit for the [PCNT_CNT_THR_EVENT_U \$n\$ _INT](#) interrupt. (RO)

Register 7.6: PCNT_INT_ST_REG (0x0084)

(reserved)								PCNT_CNT_THR_EVENT_U7_INT_ST PCNT_CNT_THR_EVENT_U6_INT_ST PCNT_CNT_THR_EVENT_U5_INT_ST PCNT_CNT_THR_EVENT_U4_INT_ST PCNT_CNT_THR_EVENT_U3_INT_ST PCNT_CNT_THR_EVENT_U2_INT_ST PCNT_CNT_THR_EVENT_U1_INT_ST PCNT_CNT_THR_EVENT_U0_INT_ST								
31								8	7	6	5	4	3	2	1	0
0x0000000								0	0	0	0	0	0	0	0	0
Reset																

PCNT_CNT_THR_EVENT_U n _INT_ST The masked interrupt status bit for the [PCNT_CNT_THR_EVENT_U \$n\$ _INT](#) interrupt. (RO)

Register 7.7: PCNT_INT_ENA_REG (0x0088)

(reserved)								PCNT_CNT_THR_EVENT_U7_INT_ENA PCNT_CNT_THR_EVENT_U6_INT_ENA PCNT_CNT_THR_EVENT_U5_INT_ENA PCNT_CNT_THR_EVENT_U4_INT_ENA PCNT_CNT_THR_EVENT_U3_INT_ENA PCNT_CNT_THR_EVENT_U2_INT_ENA PCNT_CNT_THR_EVENT_U1_INT_ENA PCNT_CNT_THR_EVENT_U0_INT_ENA								
31								8	7	6	5	4	3	2	1	0
0x0000000								0	0	0	0	0	0	0	0	0
Reset																

PCNT_CNT_THR_EVENT_U n _INT_ENA The interrupt enable bit for the [PCNT_CNT_THR_EVENT_U \$n\$ _INT](#) interrupt. (R/W)

Register 7.8: PCNT_INT_CLR_REG (0x008c)

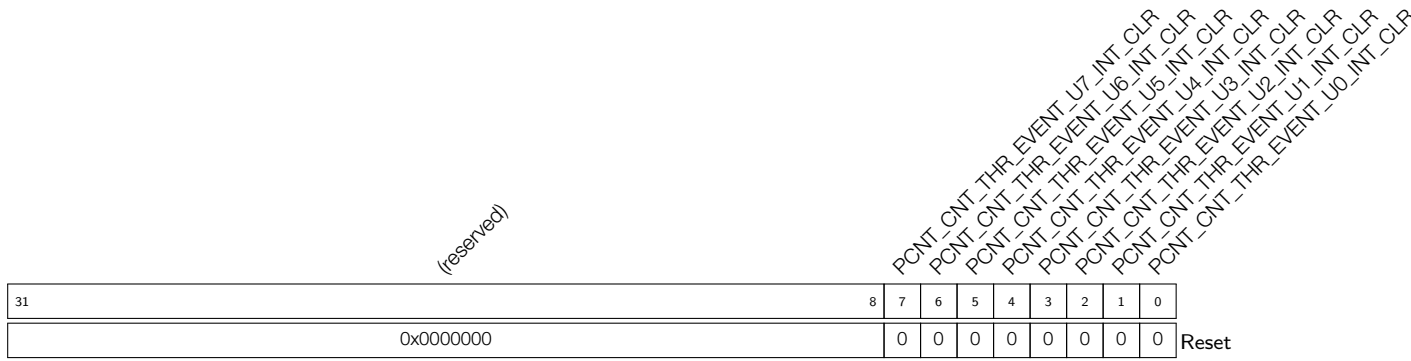

PCNT_CNT_THR_EVENT_U n _INT_CLR Set this bit to clear the **PCNT_CNT_THR_EVENT_U n _INT** interrupt. (WO)

Register 7.9: PCNT_CTRL_REG (0x00b0)

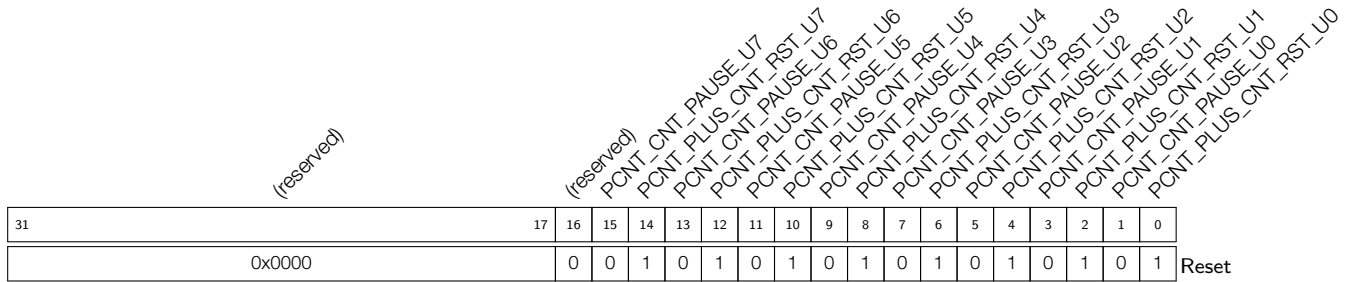

PCNT_CNT_PAUSE_U n Set this bit to freeze unit n 's counter. (R/W)

PCNT_PLUS_CNT_RST_U n Set this bit to clear unit n 's counter. (R/W)

8. 64-bit Timers

8.1 Introduction

There are four general-purpose timers embedded in the ESP32. They are all 64-bit generic timers based on 16-bit prescalers and 64-bit auto-reload-capable up/downcounters.

The ESP32 contains two timer modules, each containing two timers. The two timers in a block are indicated by an x in $TIMG_n_Tx$; the blocks themselves are indicated by an n .

The timers feature:

- A 16-bit clock prescaler, from 2 to 65536
- A 64-bit time-base counter
- Configurable up/down time-base counter: incrementing or decrementing
- Halt and resume of time-base counter
- Auto-reload at alarm
- Software-controlled instant reload
- Level and edge interrupt generation

8.2 Functional Description

8.2.1 16-bit Prescaler

Each timer uses the APB clock (APB_CLK, normally 80 MHz) as the basic clock. This clock is then divided down by a 16-bit prescaler which generates the time-base counter clock (TB_clk). Every cycle of TB_clk causes the time-base counter to increment or decrement by one. The timer must be disabled ($TIMG_n_Tx_EN$ is cleared) before changing the prescaler divisor which is configured by $TIMG_n_Tx_DIVIDER$ register; changing it on an enabled timer can lead to unpredictable results. The prescaler can divide the APB clock by a factor from 2 to 65536. Specifically, when $TIMG_n_Tx_DIVIDER$ is either 1 or 2, the clock divisor is 2; when $TIMG_n_Tx_DIVIDER$ is 0, the clock divisor is 65536. Any other value will cause the clock to be divided by exactly that value.

8.2.2 64-bit Time-base Counter

The 64-bit time-base counter can be configured to count either up or down, dependent on whether $TIMG_n_Tx_INCREASE$ is set or cleared, respectively. It supports both auto-reload and software instant reload. An alarm event can be set to trigger when the counter reaches a value specified by software.

Counting can be enabled and disabled by setting and clearing $TIMG_n_Tx_EN$. Clearing this bit essentially freezes the counter, causing it to neither count up nor count down, but instead retain its value until $TIMG_n_Tx_EN$ is set again. Reloading the counter when $TIMG_n_Tx_EN$ is cleared will change its value, but counting will not be resumed until $TIMG_n_Tx_EN$ is set.

Software can set a new counter value by setting registers $TIMG_n_Tx_LOAD_LO$ and $TIMG_n_Tx_LOAD_HI$ to the intended new value. The hardware will ignore these register settings until a reload; a reload will cause the contents of these registers to be copied to the counter itself. A reload event can be triggered by an alarm (auto-reload at alarm) or by software (software instant reload). To enable auto-reload at alarm, the register

TIMG n _Tx_AUTORELOAD should be set. If auto-reload at alarm is not enabled, the time-base counter will continue incrementing or decrementing after the alarm. To trigger a software instant reload, any value can be written to the register TIMG n _Tx_LOAD_REG; this will cause the counter value to change instantaneously. Software can also change the direction of the time-base counter instantaneously by changing the value of TIMG n _Tx_INCREASE.

The time-base counter can also be read by software, but because the counter is 64-bit, the CPU can only get the value as two 32-bit values, the counter value needs to be latched into TIMG n _TxLO_REG and TIMG n _TxHI_REG first. This is done by writing any value to TIMG n _TxUPDATE_REG; this will instantly latch the 64-bit timer value to the two registers. Software can then read them at any point of time. This approach stops the timer value being read erroneously when a carry-over happens between reading the low and high word of the timer value.

8.2.3 Alarm Generation

The timer can trigger an alarm, which can cause a reload and/or an interrupt to trigger. The alarm triggers when the alarm registers TIMG n _Tx_ALARMLO_REG and TIMG n _Tx_ALARMHI_REG match the current timer value. In order to simplify the scenario where these registers are set 'too late' and the counter already passed these values, the alarm also triggers when the current timer value is higher (for an up-counting timer) or lower (for a down-counting timer) than the current alarm value: if this is the case, the alarm will be triggered immediately upon loading the alarm registers.

8.2.4 MWDT

Each timer module also contains a Main System Watchdog Timer and associated registers. While the registers are described here, the functional description can be found in the Chapter [Watchdog Timer](#).

8.2.5 Interrupts

- TIMG n _Tx_INT_WDT_INT: Generated when a watchdog timer interrupt stage times out.
- TIMG n _Tx_INT_T1_INT: An alarm event on timer 1 generates this interrupt.
- TIMG n _Tx_INT_T0_INT: An alarm event on timer 0 generates this interrupt.

8.3 Register summary

Name	Description	TIMG0	TIMG1	Acc
Timer 0 configuration and control registers				
TIMGn_T0CONFIG_REG	Timer 0 configuration register	0x3FF5F000	0x3FF60000	R/W
TIMGn_T0LO_REG	Timer 0 current value, low 32 bits	0x3FF5F004	0x3FF60004	RO
TIMGn_T0HI_REG	Timer 0 current value, high 32 bits	0x3FF5F008	0x3FF60008	RO
TIMGn_T0UPDATE_REG	Write to copy current timer value to TIMG n _T0_(LO/HI)_REG	0x3FF5F00C	0x3FF6000C	WO
TIMGn_T0ALARMLO_REG	Timer 0 alarm value, low 32 bits	0x3FF5F010	0x3FF60010	R/W
TIMGn_T0ALARMHI_REG	Timer 0 alarm value, high bits	0x3FF5F014	0x3FF60014	R/W
TIMGn_T0LOADLO_REG	Timer 0 reload value, low 32 bits	0x3FF5F018	0x3FF60018	R/W
TIMGn_T0LOAD_REG	Write to reload timer from TIMG n _T0_(LOADLOLOADHI)_REG	0x3FF5F020	0x3FF60020	WO

Name	Description	TIMG0	TIMG1	Acc
Timer 1 configuration and control registers				
TIMG_n_T1CONFIG_REG	Timer 1 configuration register	0x3FF5F024	0x3FF60024	R/W
TIMG_n_T1LO_REG	Timer 1 current value, low 32 bits	0x3FF5F028	0x3FF60028	RO
TIMG_n_T1HI_REG	Timer 1 current value, high 32 bits	0x3FF5F02C	0x3FF6002C	RO
TIMG_n_T1UPDATE_REG	Write to copy current timer value to TIMG _n _T1_(LO/HI)_REG	0x3FF5F030	0x3FF60030	WO
TIMG_n_T1ALARMLO_REG	Timer 1 alarm value, low 32 bits	0x3FF5F034	0x3FF60034	R/W
TIMG_n_T1ALARMHI_REG	Timer 1 alarm value, high 32 bits	0x3FF5F038	0x3FF60038	R/W
TIMG_n_T1LOADLO_REG	Timer 1 reload value, low 32 bits	0x3FF5F03C	0x3FF6003C	R/W
TIMG_n_T1LOAD_REG	Write to reload timer from TIMG _n _T1_(LOADLOLOADHI)_REG	0x3FF5F044	0x3FF60044	WO
System watchdog timer configuration and control registers				
TIMG_n_Tx_WDTCONFIG0_REG	Watchdog timer configuration register	0x3FF5F048	0x3FF60048	R/W
TIMG_n_Tx_WDTCONFIG1_REG	Watchdog timer prescaler register	0x3FF5F04C	0x3FF6004C	R/W
TIMG_n_Tx_WDTCONFIG2_REG	Watchdog timer stage 0 timeout value	0x3FF5F050	0x3FF60050	R/W
TIMG_n_Tx_WDTCONFIG3_REG	Watchdog timer stage 1 timeout value	0x3FF5F054	0x3FF60054	R/W
TIMG_n_Tx_WDTCONFIG4_REG	Watchdog timer stage 2 timeout value	0x3FF5F058	0x3FF60058	R/W
TIMG_n_Tx_WDTCONFIG5_REG	Watchdog timer stage 3 timeout value	0x3FF5F05C	0x3FF6005C	R/W
TIMG_n_Tx_WDTFEED_REG	Write to feed the watchdog timer	0x3FF5F060	0x3FF60060	WO
TIMG_n_Tx_WDTWPROTECT_REG	Watchdog write protect register	0x3FF5F064	0x3FF60064	R/W
Interrupt registers				
TIMG_n_Tx_INT_RAW_REG	Raw interrupt status	0x3FF5F09C	0x3FF6009C	RO
TIMG_n_Tx_INT_ST_REG	Masked interrupt status	0x3FF5F0A0	0x3FF600A0	RO
TIMG_n_Tx_INT_ENA_REG	Interrupt enable bits	0x3FF5F098	0x3FF60098	R/W
TIMG_n_Tx_INT_CLR_REG	Interrupt clear bits	0x3FF5F0A4	0x3FF600A4	WO

8.4 Registers

Register 8.1: TIMG_n_TxCONFIG_REG (x: 0-1) (0x0+0x24*x)

31	30	29	28	13	12	11	10			
0	1	1	0x00001				0	0	0	Reset

TIMG_n_Tx_EN When set, the timer *x* time-base counter is enabled. (R/W)

TIMG_n_Tx_INCREASE When set, the timer *x* time-base counter will increment every clock tick. When cleared, the timer *x* time-base counter will decrement. (R/W)

TIMG_n_Tx_AUTORELOAD When set, timer *x* auto-reload at alarm is enabled. (R/W)

TIMG_n_Tx_DIVIDER Timer *x* clock (Tx_clk) prescale value. (R/W)

TIMG_n_Tx_EDGE_INT_EN When set, an alarm will generate an edge type interrupt. (R/W)

TIMG_n_Tx_LEVEL_INT_EN When set, an alarm will generate a level type interrupt. (R/W)

TIMG_n_Tx_ALARM_EN When set, the alarm is enabled. (R/W)

Register 8.2: TIMG_n_TxLO_REG (x: 0-1) (0x4+0x24*x)

31	0
0x00000000	
	Reset

TIMG_n_TxLO_REG After writing to TIMG_n_TxUPDATE_REG, the low 32 bits of the time-base counter of timer *x* can be read here. (RO)

Register 8.3: TIMG_n_TxHI_REG (x: 0-1) (0x8+0x24*x)

31	0
0x00000000	
	Reset

TIMG_n_TxHI_REG After writing to TIMG_n_TxUPDATE_REG, the high 32 bits of the time-base counter of timer *x* can be read here. (RO)

Register 8.4: TIMG_n_TXUPDATE_REG (x: 0-1) (0xC+0x24*x)

31	0
0x00000000	
Reset	

TIMG_n_TXUPDATE_REG Write any value to trigger a timer *x* time-base counter value update (timer *x* current value will be stored in registers above). (WO)

Register 8.5: TIMG_n_TXALARMLO_REG (x: 0-1) (0x10+0x24*x)

31	0
0x00000000	
Reset	

TIMG_n_TXALARMLO_REG Timer *x* alarm trigger time-base counter value, low 32 bits. (R/W)

Register 8.6: TIMG_n_TXALARMHI_REG (x: 0-1) (0x14+0x24*x)

31	0
0x00000000	
Reset	

TIMG_n_TXALARMHI_REG Timer *x* alarm trigger time-base counter value, high 32 bits. (R/W)

Register 8.7: TIMG_n_TXLOADLO_REG (x: 0-1) (0x18+0x24*x)

31	0
0x00000000	
Reset	

TIMG_n_TXLOADLO_REG Low 32 bits of the value that a reload will load into timer *x* time-base counter. (R/W)

Register 8.8: TIMG_n_TXLOADHI_REG (x: 0-1) (0x1C+0x24*x)

31	0
0x00000000	
Reset	

TIMG_n_TXLOADHI_REG High 32 bits of the value that a reload will load into timer *x* time-base counter. (R/W)

Register 8.9: TIMG_n_TxLOAD_REG (x: 0-1) (0x20+0x24*x)

31	0
0x00000000	
Reset	

TIMG_n_TxLOAD_REG Write any value to trigger a timer *x* time-base counter reload. (WO)

Register 8.10: TIMG_n_Tx_WDTCONFIG0_REG (0x0048)

<i>TIMG_n_Tx_WDT_EN</i>		<i>TIMG_n_Tx_WDT_STG0</i>		<i>TIMG_n_Tx_WDT_STG1</i>		<i>TIMG_n_Tx_WDT_STG2</i>		<i>TIMG_n_Tx_WDT_STG3</i>		<i>TIMG_n_Tx_WDT_EDGE_INT_EN</i>		<i>TIMG_n_Tx_WDT_LEVEL_INT_EN</i>		<i>TIMG_n_Tx_WDT_CPU_RESET_LENGTH</i>		<i>TIMG_n_Tx_WDT_SYS_RESET_LENGTH</i>		<i>TIMG_n_Tx_WDT_FLASHBOOT_MOD_EN</i>		
31	30	29	28	27	26	25	24	23	22	21	20	18	17	15	14					
0	0	0	0	0	0	0	0	0	0	0	0x1	0x1	0x1	0x1	1	Reset				

TIMG_n_Tx_WDT_EN When set, MWDT is enabled. (R/W)

TIMG_n_Tx_WDT_STG0 Stage 0 configuration. 0: off, 1: interrupt, 2: reset CPU, 3: reset system. (R/W)

TIMG_n_Tx_WDT_STG1 Stage 1 configuration. 0: off, 1: interrupt, 2: reset CPU, 3: reset system. (R/W)

TIMG_n_Tx_WDT_STG2 Stage 2 configuration. 0: off, 1: interrupt, 2: reset CPU, 3: reset system. (R/W)

TIMG_n_Tx_WDT_STG3 Stage 3 configuration. 0: off, 1: interrupt, 2: reset CPU, 3: reset system. (R/W)

TIMG_n_Tx_WDT_EDGE_INT_EN When set, an edge type interrupt will be generated on timeout of a stage configured to generate an interrupt. (R/W)

TIMG_n_Tx_WDT_LEVEL_INT_EN When set, a level type interrupt will be generated on timeout of a stage configured to generate an interrupt. (R/W)

TIMG_n_Tx_WDT_CPU_RESET_LENGTH CPU reset signal length selection. 0: 100 ns, 1: 200 ns, 2: 300 ns, 3: 400 ns, 4: 500 ns, 5: 800 ns, 6: 1.6 μ s, 7: 3.2 μ s. (R/W)

TIMG_n_Tx_WDT_SYS_RESET_LENGTH System reset signal length selection. 0: 100 ns, 1: 200 ns, 2: 300 ns, 3: 400 ns, 4: 500 ns, 5: 800 ns, 6: 1.6 μ s, 7: 3.2 μ s. (R/W)

TIMG_n_Tx_WDT_FLASHBOOT_MOD_EN When set, Flash boot protection is enabled. (R/W)

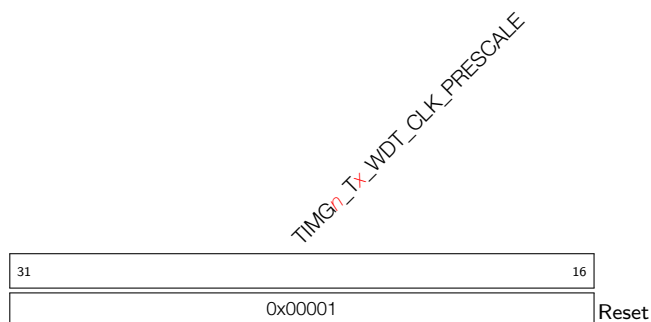
Register 8.11: TIMG_n_Tx_WDTCONFIG1_REG (0x004c)

TIMG_n_Tx_WDT_CLK_PRESCALE MWDT clock prescale value. MWDT clock period = 12.5 ns *
TIMG_n_Tx_WDT_CLK_PRESCALE. (R/W)

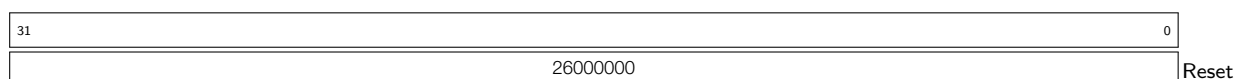
Register 8.12: TIMG_n_Tx_WDTCONFIG2_REG (0x0050)

TIMG_n_Tx_WDTCONFIG2_REG Stage 0 timeout value, in MWDT clock cycles. (R/W)

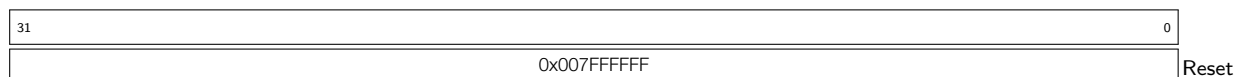
Register 8.13: TIMG_n_Tx_WDTCONFIG3_REG (0x0054)

TIMG_n_Tx_WDTCONFIG3_REG Stage 1 timeout value, in MWDT clock cycles. (R/W)

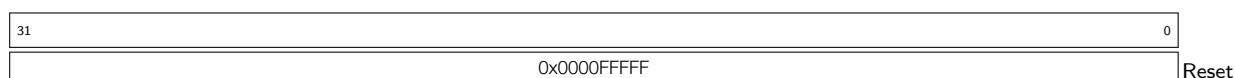
Register 8.14: TIMG_n_Tx_WDTCONFIG4_REG (0x0058)

TIMG_n_Tx_WDTCONFIG4_REG Stage 2 timeout value, in MWDT clock cycles. (R/W)

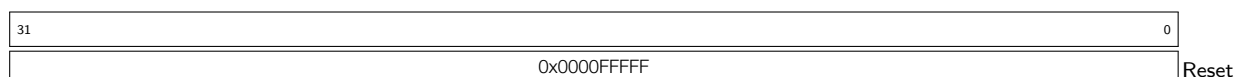
Register 8.15: TIMG_n_Tx_WDTCONFIG5_REG (0x005c)

TIMG_n_Tx_WDTCONFIG5_REG Stage 3 timeout value, in MWDT clock cycles. (R/W)

Register 8.16: TIMG_n_Tx_WDTFEED_REG (0x0060)

31	0
0x00000000	
Reset	

TIMG_n_Tx_WDTFEED_REG Write any value to feed the MWDT. (WO)

Register 8.17: TIMG_n_Tx_WDTWPROTECT_REG (0x0064)

31	0
0x050D83AA1	
Reset	

TIMG_n_Tx_WDTWPROTECT_REG If the register contains a different value than its reset value, write protection is enabled. (R/W)

Register 8.18: TIMG_n_Tx_INT_ENA_REG (0x0098)

(reserved)																															3	2	1	0	Reset
31	0 0																														0	0	0	0	

TIMG_n_Tx_INT_WDT_INT_ENA
 TIMG_n_Tx_INT_T1_INT_ENA
 TIMG_n_Tx_INT_T0_INT_ENA

TIMG_n_Tx_INT_WDT_INT_ENA The interrupt enable bit for the TIMG_n_Tx_INT_WDT_INT interrupt. (R/W) (R/W)

TIMG_n_Tx_INT_T1_INT_ENA The interrupt enable bit for the TIMG_n_Tx_INT_T1_INT interrupt. (R/W) (R/W)

TIMG_n_Tx_INT_T0_INT_ENA The interrupt enable bit for the TIMG_n_Tx_INT_T0_INT interrupt. (R/W) (R/W)

Register 8.19: TIMG_n_Tx_INT_RAW_REG (0x009c)

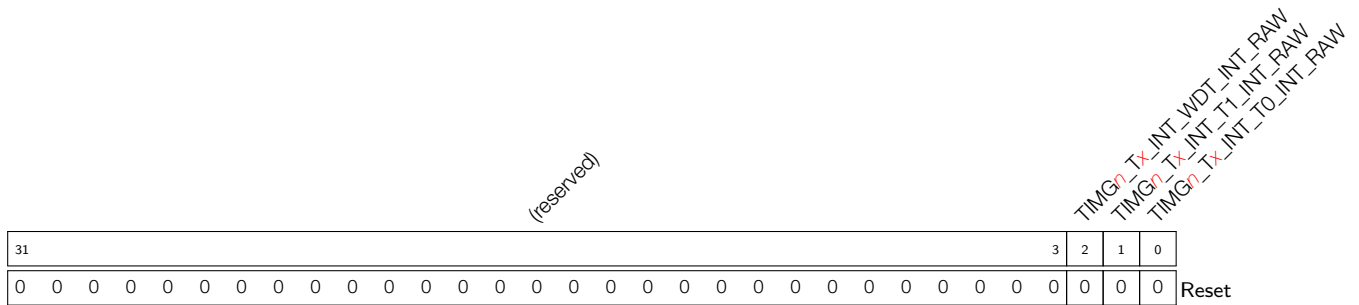

TIMG_n_Tx_INT_WDT_INT_RAW The raw interrupt status bit for the TIMG_n_Tx_INT_WDT_INT interrupt. (RO)

TIMG_n_Tx_INT_T1_INT_RAW The raw interrupt status bit for the TIMG_n_Tx_INT_T1_INT interrupt. (RO)

TIMG_n_Tx_INT_T0_INT_RAW The raw interrupt status bit for the TIMG_n_Tx_INT_T0_INT interrupt. (RO)

Register 8.20: TIMG_n_Tx_INT_ST_REG (0x00a0)

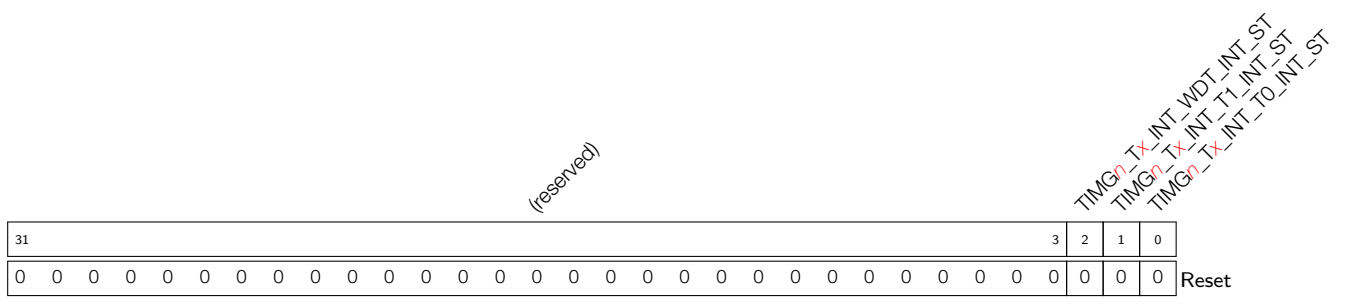

TIMG_n_Tx_INT_WDT_INT_ST The masked interrupt status bit for the TIMG_n_Tx_INT_WDT_INT interrupt. (RO)

TIMG_n_Tx_INT_T1_INT_ST The masked interrupt status bit for the TIMG_n_Tx_INT_T1_INT interrupt. (RO)

TIMG_n_Tx_INT_T0_INT_ST The masked interrupt status bit for the TIMG_n_Tx_INT_T0_INT interrupt. (RO)

Register 8.21: TIMG_n_Tx_INT_CLR_REG (0x00a4)

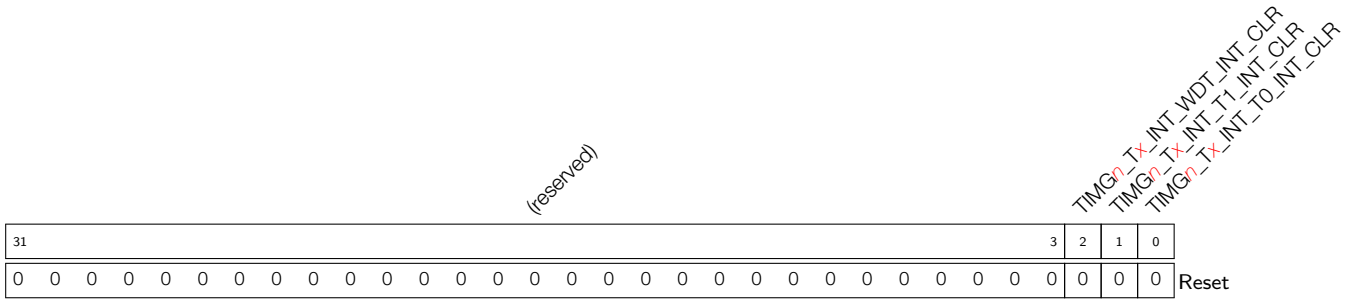

TIMG_n_Tx_INT_WDT_INT_CLR Set this bit to clear the TIMG_n_Tx_INT_WDT_INT interrupt. (WO)

TIMG_n_Tx_INT_T1_INT_CLR Set this bit to clear the TIMG_n_Tx_INT_T1_INT interrupt. (WO)

TIMG_n_Tx_INT_T0_INT_CLR Set this bit to clear the TIMG_n_Tx_INT_T0_INT interrupt. (WO)

9. Watchdog Timers

9.1 Introduction

The ESP32 has three watchdog timers: one in each of the two timer modules (called Main System Watchdog Timer, or MWDT) and one in the RTC module (which is called the RTC Watchdog Timer, or RWDT). These watchdog timers are intended to recover from an unforeseen fault, causing the application program to abandon its normal sequence. A watchdog timer has 4 stages. Each stage may take one of three or four actions on expiry of a programmed time period for this stage unless the watchdog is fed or disabled. The actions are: interrupt, CPU reset, core reset and system reset. Only the RWDT can trigger the system reset, and is able to reset the entire chip and the main system, including the RTC itself. A timeout value can be set for each stage individually.

During flash boot the RWDT and the first MWDT start automatically in order to detect and recover from booting problems.

9.2 Features

- 4 stages, each can be configured or disabled separately
- Programmable time period for each stage
- One of 3 or 4 possible actions (interrupt, CPU reset, core reset and system reset) on expiration of each stage
- 32-bit expiry counter
- Write protection, to prevent the RWDT and MWDT configuration from being inadvertently altered.
- Flash boot protection
If the boot process from an SPI flash does not complete within a predetermined time period, the watchdog will reboot the entire main system.

9.3 Functional Description

9.3.1 Clock

The RWDT is clocked from the RTC slow clock, which usually will be 32 KHz. The MWDT clock source is derived from the APB clock via a pre-MWDT 16-bit configurable prescaler. For either watchdog, the clock source is fed into the 32-bit expiry counter. When this counter reaches the timeout value of the current stage, the action configured for the stage will execute, the expiry counter will be reset and the next stage will be made active.

9.3.1.1 Operating Procedure

When a watchdog timer is enabled, it will proceed in loops from stage 0 to stage 3, then back to stage 0 and start again. The expiry action and time period for each stage can be configured individually.

Every stage can be configured for one of the following actions when the expiry timer reaches the stages timeout value:

- Trigger an interrupt
When the stage expires an interrupt is triggered.
- Reset a CPU core
When the stage expires the designated CPU core will be reset. MWDT0 CPU reset only resets the PRO CPU. MWDT1 CPU reset only resets the APP CPU. The RWDT CPU reset can reset either or both or none depending on configuration.
- Reset the main system
When the stage expires, the main system, including the MWDTs, will be reset. In this article, main system refers to CPU and all peripherals. The RTC is an exception to this and it will not be reset.
- Reset the main system and RTC
When the stage expires the main system and the RTC will both be reset. This action is only available in the RWDT.
- Disabled
This stage will have no effects on the system.

When software feeds the the watchdog timer, it returns to stage 0 and its expiry counter restarts from 0.

9.3.1.2 Write Protection

Both the MWDTs as well as the RWDT can be protected from accidental writing. To accomplish this, they have a write-key register (TIMERS_WDT_WKEY for the MWDT, RTC_CNTL_WDT_WKEY for the RWDT.) On reset, these registers are initialized to the value 0x50D83AA1. When the value in this register is changed from 0x50D83AA1, write protection is enabled. Writes to any WDT register, including the feeding register (but excluding the write-key register itself), are ignored. The recommended procedure for accessing a WDT is:

1. Disable the write protection
2. Make the required modification or feed the watchdog
3. Re-enable the write protection

9.3.1.3 Flash Boot Protection

During flash booting, the MWDT in timer group 0 (TIMG0) as well as the RWDT are automatically enabled. Stage 0 for the enabled MWDT is automatically configured to reset the system upon expiry; stage 0 for the RWDT resets the RTC when it expires. After booting, the register TIMERS_WDT_FLASHBOOT_MOD_EN should be cleared to stop the flash boot protection procedure for the MWDT, and RTC_CNTL_WDT_FLASHBOOT_MOD_EN should be cleared to do the same for the RWDT. After this, the MWDT and RWDT can be configured by software.

9.3.1.4 Registers

The MWDT registers are part of the timer submodule and are described in the [Timer Registers](#) section. The RWDT registers are part of the RTC submodule and are described in the [RTC Registers](#) section.

10. AES Accelerator

10.1 Introduction

The AES Accelerator speeds up AES operations significantly compared to AES algorithms implemented solely in software. The AES Accelerator supports 6 algorithms of FIPS PUB 197, specifically AES-128, AES-192 and AES-256 encryption and decryption.

10.2 Features

- Supports AES-128 encryption and decryption
- Supports AES-192 encryption and decryption
- Supports AES-256 encryption and decryption
- Supports 4 variations of key endianness and 4 variations of text endianness

10.3 Functional Description

10.3.1 AES Algorithm Operations

The AES Accelerator supports 6 algorithms of FIPS PUB 197, specifically AES-128, AES-192 and AES-256 encryption and decryption. The AES_MODE_REG register can be configured to different values to enable different algorithm operations, as is shown in Table 26.

Table 26: Operation Mode

AES_MODE_REG[2:0]	Operation
0	AES-128 Encryption
1	AES-192 Encryption
2	AES-256 Encryption
4	AES-128 Decryption
5	AES-192 Decryption
6	AES-256 Decryption

10.3.2 Key, Plaintext and Ciphertext

The encryption or decryption key is stored in AES_KEY_*n*_REG, which is a set of eight 32-bit registers. For AES-128 encryption/decryption, the 128-bit key is stored in AES_KEY_0_REG ~ AES_KEY_3_REG. For AES-192 encryption/decryption, the 192-bit key is stored in AES_KEY_0_REG ~ AES_KEY_5_REG. For AES-256 encryption/decryption, the 256-bit key is stored in AES_KEY_0_REG ~ AES_KEY_7_REG.

Plaintext and ciphertext is stored in the AES_TEXT_*m*_REG registers. There are four 32-bit registers. To enable AES-128/192/256 encryption, initialize the AES_TEXT_*m*_REG registers with plaintext before encryption. When encryption is finished, the AES Accelerator will store back the resulting ciphertext in the AES_TEXT_*m*_REG registers. To enable AES-128/192/256 decryption, initialize the AES_TEXT_*m*_REG registers with ciphertext before decryption. When decryption is finished, the AES Accelerator will store back the resulting plaintext in the AES_TEXT_*m*_REG registers.

10.3.3 Endianness

Key Endianness

Bit 0 and bit 1 in AES_ENDIAN_REG define the key endianness. For detailed information, please refer to Table 28, Table 29 and Table 30. $w[0] \sim w[3]$ in Table 28, $w[0] \sim w[5]$ in Table 29 and $w[0] \sim w[7]$ in Table 30 are “the first Nk words of the expanded key” as specified in “5.2: Key Expansion” of FIPS PUB 197. “Column Bit” specifies the bytes in the word from $w[0]$ to $w[7]$. The bytes of AES_KEY_n_REG comprise “the first Nk words of the expanded key”.

Text Endianness

Bit 2 and bit 3 in AES_ENDIAN_REG define the endianness of input text, while Bit 4 and Bit 5 define the endianness of output text. The input text refers to the plaintext in AES-128/192/256 encryption and the ciphertext in decryption. The output text refers to the ciphertext in AES-128/192/256 encryption and the plaintext in decryption. For details, please refer to Table 27. “State” in Table 27 is defined as that in “3.4: The State” of FIPS PUB 197: “The AES algorithm operations are performed on a two-dimensional array of bytes called the State”. The ciphertext or plaintexts stored in each byte of AES_KEY_n_REG comprise the State.

Table 27: AES Text Endianness

AES_ENDIAN_REG[3]/[5]	AES_ENDIAN_REG[2]/[4]	Plaintext/ciphertext					
0	0	State		c			
		r	0	AES_KEY_3_REG[31:24]	AES_KEY_2_REG[31:24]	AES_KEY_1_REG[31:24]	AES_KEY_0_REG[31:24]
			1	AES_KEY_3_REG[23:16]	AES_KEY_2_REG[23:16]	AES_KEY_1_REG[23:16]	AES_KEY_0_REG[23:16]
			2	AES_KEY_3_REG[15:8]	AES_KEY_2_REG[15:8]	AES_KEY_1_REG[15:8]	AES_KEY_0_REG[15:8]
			3	AES_KEY_3_REG[7:0]	AES_KEY_2_REG[7:0]	AES_KEY_1_REG[7:0]	AES_KEY_0_REG[7:0]
0	0	State		c			
		r	0	AES_KEY_3_REG[7:0]	AES_KEY_2_REG[7:0]	AES_KEY_1_REG[7:0]	AES_KEY_0_REG[7:0]
			1	AES_KEY_3_REG[15:8]	AES_KEY_2_REG[15:8]	AES_KEY_1_REG[15:8]	AES_KEY_0_REG[15:8]
			2	AES_KEY_3_REG[23:16]	AES_KEY_2_REG[23:16]	AES_KEY_1_REG[23:16]	AES_KEY_0_REG[23:16]
			3	AES_KEY_3_REG[31:24]	AES_KEY_2_REG[31:24]	AES_KEY_1_REG[31:24]	AES_KEY_0_REG[31:24]
0	0	State		c			
		r	0	AES_KEY_3_REG[31:24]	AES_KEY_2_REG[31:24]	AES_KEY_1_REG[31:24]	AES_KEY_0_REG[31:24]
			1	AES_KEY_3_REG[23:16]	AES_KEY_2_REG[23:16]	AES_KEY_1_REG[23:16]	AES_KEY_0_REG[23:16]
			2	AES_KEY_3_REG[15:8]	AES_KEY_2_REG[15:8]	AES_KEY_1_REG[15:8]	AES_KEY_0_REG[15:8]
			3	AES_KEY_3_REG[7:0]	AES_KEY_2_REG[7:0]	AES_KEY_1_REG[7:0]	AES_KEY_0_REG[7:0]
0	0	State		c			
		r	0	AES_KEY_3_REG[7:0]	AES_KEY_2_REG[7:0]	AES_KEY_1_REG[7:0]	AES_KEY_0_REG[7:0]
			1	AES_KEY_3_REG[15:8]	AES_KEY_2_REG[15:8]	AES_KEY_1_REG[15:8]	AES_KEY_0_REG[15:8]
			2	AES_KEY_3_REG[23:16]	AES_KEY_2_REG[23:16]	AES_KEY_1_REG[23:16]	AES_KEY_0_REG[23:16]
			3	AES_KEY_3_REG[31:24]	AES_KEY_2_REG[31:24]	AES_KEY_1_REG[31:24]	AES_KEY_0_REG[31:24]

10.3.4 Encryption and Decryption Operations

Single Operation

1. Initialize AES_MODE_REG, AES_KEY_n_REG, AES_TEXT_m_REG and AES_ENDIAN_REG.
2. Write 1 to AES_START_REG.
3. Wait until AES_IDLE_REG reads 1.
4. Read results from AES_TEXT_m_REG.

Consecutive Operations

Every time when an operation is completed, only AES_TEXT_m_REG is modified by the AES Accelerator. Initialization can be therefore be simplified in a series of consecutive operations.

1. Update contents of AES_MODE_REG, AES_KEY_n_REG and AES_ENDIAN_REG if required.
2. Load AES_TEXT_m_REG.
3. Write 1 to AES_START_REG.
4. Wait until AES_IDLE_REG reads 1.
5. Read results from AES_TEXT_m_REG.

10.3.5 Speed

The AES Accelerator requires 11 to 15 clock cycles to encrypt a message block and 21 or 22 clock cycles to decrypt a message block.

10.4 Register summary

Name	Description	Address	Access
Configuration registers			
AES_MODE_REG	Mode of operation of the AES Accelerator	0x3FF01008	R/W
AES_ENDIAN_REG	Endianness configuration register	0x3FF01040	R/W
Key registers			
AES_KEY_0_REG	AES key material register 0	0x3FF01010	R/W
AES_KEY_1_REG	AES key material register 1	0x3FF01014	R/W
AES_KEY_2_REG	AES key material register 2	0x3FF01018	R/W
AES_KEY_3_REG	AES key material register 3	0x3FF0101C	R/W
AES_KEY_4_REG	AES key material register 4	0x3FF01020	R/W
AES_KEY_5_REG	AES key material register 5	0x3FF01024	R/W
AES_KEY_6_REG	AES key material register 6	0x3FF01028	R/W
AES_KEY_7_REG	AES key material register 7	0x3FF0102C	R/W
Encrypted/decrypted data registers			
AES_TEXT_0_REG	AES encrypted/decrypted data register 0	0x3FF01030	R/W
AES_TEXT_1_REG	AES encrypted/decrypted data register 1	0x3FF01034	R/W
AES_TEXT_2_REG	AES encrypted/decrypted data register 2	0x3FF01038	R/W
AES_TEXT_3_REG	AES encrypted/decrypted data register 3	0x3FF0103C	R/W
Control/status registers			

Name	Description	Address	Access
AES_START_REG	AES operation start control register	0x3FF01000	WO
AES_IDLE_REG	AES idle status register	0x3FF01004	RO

10.5 Registers

Register 10.1: AES_START_REG (0x000)

31	(reserved)	1	0	AES_START
0x00000000				x
				Reset

AES_START Write 1 to start the AES operation. (WO)

Register 10.2: AES_IDLE_REG (0x004)

31	(reserved)	1	0	AES_IDLE
0x00000000				1
				Reset

AES_IDLE AES Idle register. Reads 0 while the AES Accelerator is busy processing, 1 otherwise. (RO)

Register 10.3: AES_MODE_REG (0x008)

31	(reserved)	3	2	0	AES_MODE
0x00000000				0	Reset

AES_MODE Selects the AES accelerator mode of operation. See Table 26 for details. (R/W)

Register 10.4: AES_KEY_n_REG (n: 0-7) (0x10+4*n)

31	0
0x00000000	
Reset	

AES_KEY_n_REG (n: 0-7) AES key material register. (R/W)

Register 10.5: AES_TEXT_m_REG (m: 0-3) (0x30+4*m)

31	0
0x00000000	
Reset	

AES_TEXT_m_REG (m: 0-3) Plaintext and ciphertext register. (R/W)

Register 10.6: AES_ENDIAN_REG (0x040)

(reserved)						AES_ENDIAN							
31						6	5					0	
0x0000000						1	1	1	1	1	1	1	Reset

AES_ENDIAN Endianness selection register. See Table 27 for details. (R/W)

11. SHA Accelerator

11.1 Introduction

The SHA Accelerator is included to speed up SHA hashing operations significantly compared to SHA hashing algorithms implemented solely in software. The SHA Accelerator supports 4 algorithms of FIPS PUB 180-4, specifically SHA-1, SHA-256, SHA-384 and SHA-512.

11.2 Features

Hardware support for popular secure hashing algorithms:

- SHA-1
- SHA-256
- SHA-384
- SHA-512

11.3 Functional Description

11.3.1 Padding and Parsing the Message

The SHA Accelerator can only accept one message block at a time. Software divides the message into blocks according to “5.2 Parsing the Message” in FIPS PUB 180-4 and writes one block to the SHA_TEXT_0_REG registers at a time. For SHA-1 and SHA-256, software writes a 512-bit message block to SHA_TEXT_0_REG ~ SHA_TEXT_15_REG each time. For SHA-384 and SHA-512, software writes a 1024-bit message block to SHA_TEXT_0_REG ~ SHA_TEXT_31_REG each time.

The SHA Accelerator is unable to perform the padding operation of “5.1 Padding the Message” in FIPS PUB 180-4; Note that the user software is expected to pad the message before feeding it into the accelerator.

As described in “2.2.1: Parameters” in FIPS PUB 180-4, “ $M_0^{(i)}$ is the left-most word of message block i ”. $M_0^{(i)}$ is stored in SHA_TEXT_0_REG. In the same fashion, the SHA_TEXT_1_REG register stores the second left-most word of a message block $H_1^{(N)}$, etc.

11.3.2 Message Digest

When the hashing operation is finished, the message digest will be refreshed by SHA Accelerator and will be stored in SHA_TEXT_0_REG. SHA-1 produces a 160-bit message digest and stores it in SHA_TEXT_0_REG ~ SHA_TEXT_4_REG. SHA-256 produces a 256-bit message digest and stores it in SHA_TEXT_0_REG ~ SHA_TEXT_7_REG. SHA-384 produces a 384-bit message digest and stores it in SHA_TEXT_0_REG ~ SHA_TEXT_11_REG. SHA-512 produces a 512-bit message digest and stores it in SHA_TEXT_0_REG ~ SHA_TEXT_15_REG.

As is described in “2.2.1 Parameters” in FIPS PUB 180-4, “ $H^{(N)}$ is the final hash value and is used to determine the message digest” and “ $H_0^{(i)}$ is the left-most word of hash value i ”, so the left-most word $H_0^{(N)}$ in the message digest is stored in SHA_TEXT_0_REG. In the same fashion, the second left-most word $H_1^{(N)}$ in the message digest is stored in SHA_TEXT_1_REG, etc.

11.3.3 Hash Operation

There is a set of control registers for SHA-1, SHA-256, SHA-384 and SHA-512 respectively; different hashing algorithms use different control registers.

SHA-1 uses SHA_SHA1_START_REG, SHA_SHA1_CONTINUE_REG, SHA_SHA1_LOAD_REG and SHA_SHA1_BUSY_REG.

SHA-256 uses SHA_SHA256_START_REG, SHA_SHA256_CONTINUE_REG, SHA_SHA256_LOAD_REG and SHA_SHA256_BUSY_REG. SHA-384 uses SHA_SHA384_START_REG, SHA_SHA384_CONTINUE_REG, SHA_SHA384_LOAD_REG and SHA_SHA384_BUSY_REG.

SHA-512 uses SHA_SHA512_START_REG, SHA_SHA512_CONTINUE_REG, SHA_SHA512_LOAD_REG and SHA_SHA512_BUSY_REG. For detailed operation, please refer to the following steps.

1. Feed the accelerator the first message block:
 - (a) Use the first message block to initialize SHA_TEXT_0_REG.
 - (b) Write 1 to SHA_X_START_REG.
 - (c) Wait for SHA_X_BUSY_REG to read 0, indicating that operation is completed.
2. Similarly, feed the accelerator with subsequent message blocks:
 - (a) Initialize SHA_TEXT_1_REG using the subsequent message block.
 - (b) Write 1 to SHA_X_CONTINUE_REG.
 - (c) Wait for SHA_X_BUSY_REG to read 0, indicating that operation is completed.
3. Get message digest:
 - (a) Write 1 to SHA_X_LOAD_REG.
 - (b) Wait for SHA_X_BUSY_REG to read 0, indicating that operation is completed.
 - (c) Read message digest from SHA_TEXT_7_REG.

11.3.4 Speed

The SHA Accelerator requires 60 to 100 clock cycles to process a message block and 8 to 20 clock cycles to calculate the final digest.

11.4 Register Summary

Name	Description	Address	Access
Encrypted/decrypted data registers			
SHA_TEXT_0_REG	SHA encrypted/decrypted data register 0	0x3FF03000	R/W
SHA_TEXT_1_REG	SHA encrypted/decrypted data register 1	0x3FF03004	R/W
SHA_TEXT_2_REG	SHA encrypted/decrypted data register 2	0x3FF03008	R/W
SHA_TEXT_3_REG	SHA encrypted/decrypted data register 3	0x3FF0300C	R/W
SHA_TEXT_4_REG	SHA encrypted/decrypted data register 4	0x3FF03010	R/W
SHA_TEXT_5_REG	SHA encrypted/decrypted data register 5	0x3FF03014	R/W
SHA_TEXT_6_REG	SHA encrypted/decrypted data register 6	0x3FF03018	R/W
SHA_TEXT_7_REG	SHA encrypted/decrypted data register 7	0x3FF0301C	R/W

Name	Description	Address	Access
SHA_TEXT_8_REG	SHA encrypted/decrypted data register 8	0x3FF03020	R/W
SHA_TEXT_9_REG	SHA encrypted/decrypted data register 9	0x3FF03024	R/W
SHA_TEXT_10_REG	SHA encrypted/decrypted data register 10	0x3FF03028	R/W
SHA_TEXT_11_REG	SHA encrypted/decrypted data register 11	0x3FF0302C	R/W
SHA_TEXT_12_REG	SHA encrypted/decrypted data register 12	0x3FF03030	R/W
SHA_TEXT_13_REG	SHA encrypted/decrypted data register 13	0x3FF03034	R/W
SHA_TEXT_14_REG	SHA encrypted/decrypted data register 14	0x3FF03038	R/W
SHA_TEXT_15_REG	SHA encrypted/decrypted data register 15	0x3FF0303C	R/W
SHA_TEXT_16_REG	SHA encrypted/decrypted data register 16	0x3FF03040	R/W
SHA_TEXT_17_REG	SHA encrypted/decrypted data register 17	0x3FF03044	R/W
SHA_TEXT_18_REG	SHA encrypted/decrypted data register 18	0x3FF03048	R/W
SHA_TEXT_19_REG	SHA encrypted/decrypted data register 19	0x3FF0304C	R/W
SHA_TEXT_20_REG	SHA encrypted/decrypted data register 20	0x3FF03050	R/W
SHA_TEXT_21_REG	SHA encrypted/decrypted data register 21	0x3FF03054	R/W
SHA_TEXT_22_REG	SHA encrypted/decrypted data register 22	0x3FF03058	R/W
SHA_TEXT_23_REG	SHA encrypted/decrypted data register 23	0x3FF0305C	R/W
SHA_TEXT_24_REG	SHA encrypted/decrypted data register 24	0x3FF03060	R/W
SHA_TEXT_25_REG	SHA encrypted/decrypted data register 25	0x3FF03064	R/W
SHA_TEXT_26_REG	SHA encrypted/decrypted data register 26	0x3FF03068	R/W
SHA_TEXT_27_REG	SHA encrypted/decrypted data register 27	0x3FF0306C	R/W
SHA_TEXT_28_REG	SHA encrypted/decrypted data register 28	0x3FF03070	R/W
SHA_TEXT_29_REG	SHA encrypted/decrypted data register 29	0x3FF03074	R/W
SHA_TEXT_30_REG	SHA encrypted/decrypted data register 30	0x3FF03078	R/W
SHA_TEXT_31_REG	SHA encrypted/decrypted data register 31	0x3FF0307C	R/W
Control/status registers			
SHA_SHA1_START_REG	Control register to initiate SHA1 operation	0x3FF03080	WO
SHA_SHA1_CONTINUE_REG	Control register to continue SHA1 operation	0x3FF03084	WO
SHA_SHA1_LOAD_REG	Control register to calculate the final SHA1 hash	0x3FF03088	WO
SHA_SHA1_BUSY_REG	Status register for SHA1 operation	0x3FF0308C	RO
SHA_SHA256_START_REG	Control register to initiate SHA256 operation	0x3FF03090	WO
SHA_SHA256_CONTINUE_REG	Control register to continue SHA256 operation	0x3FF03094	WO
SHA_SHA256_LOAD_REG	Control register to calculate the final SHA256 hash	0x3FF03098	WO
SHA_SHA256_BUSY_REG	Status register for SHA256 operation	0x3FF0309C	RO
SHA_SHA384_START_REG	Control register to initiate SHA384 operation	0x3FF030A0	WO
SHA_SHA384_CONTINUE_REG	Control register to continue SHA384 operation	0x3FF030A4	WO
SHA_SHA384_LOAD_REG	Control register to calculate the final SHA384 hash	0x3FF030A8	WO
SHA_SHA384_BUSY_REG	Status register for SHA384 operation	0x3FF030AC	RO
SHA_SHA512_START_REG	Control register to initiate SHA512 operation	0x3FF030B0	WO
SHA_SHA512_CONTINUE_REG	Control register to continue SHA512 operation	0x3FF030B4	WO
SHA_SHA512_LOAD_REG	Control register to calculate the final SHA512 hash	0x3FF030B8	WO
SHA_SHA512_BUSY_REG	Status register for SHA512 operation	0x3FF030BC	RO

11.5 Registers

Register 11.1: SHA_TEXT_*n*_REG (*n*: 0-31) (0x0+4n*)**

31			0
(reserved)			Reset
0x00000000			0

SHA_TEXT_*n*_REG (*n*: 0-31) SHA Message block and hash result register. (R/W)

Register 11.2: SHA_SHA1_START_REG (0x080)

31			1	0
(reserved)			SHA_SHA1_START	
0x00000000			0	Reset

SHA_SHA1_START Write 1 to start an SHA-1 operation on the first message block. (WO)

Register 11.3: SHA_SHA1_CONTINUE_REG (0x084)

31			1	0
(reserved)			SHA_SHA1_CONTINUE	
0x00000000			0	Reset

SHA_SHA1_CONTINUE Write 1 to continue the SHA-1 operation with subsequent blocks. (WO)

Register 11.4: SHA_SHA1_LOAD_REG (0x088)

31			1	0
(reserved)			SHA_SHA1_LOAD	
0x00000000			0	Reset

SHA_SHA1_LOAD Write 1 to finish the SHA-1 operation to calculate the final the message hash.
(WO)

Register 11.5: SHA_SHA1_BUSY_REG (0x08C)

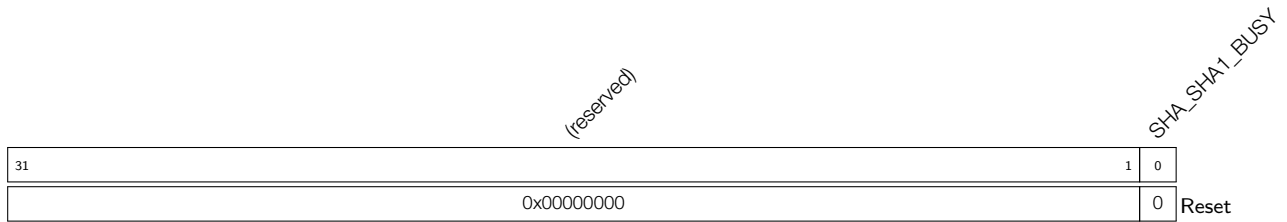

SHA_SHA1_BUSY SHA-1 operation status: 1 if the SHA accelerator is processing data, 0 if idle. (RO)

Register 11.6: SHA_SHA256_START_REG (0x090)

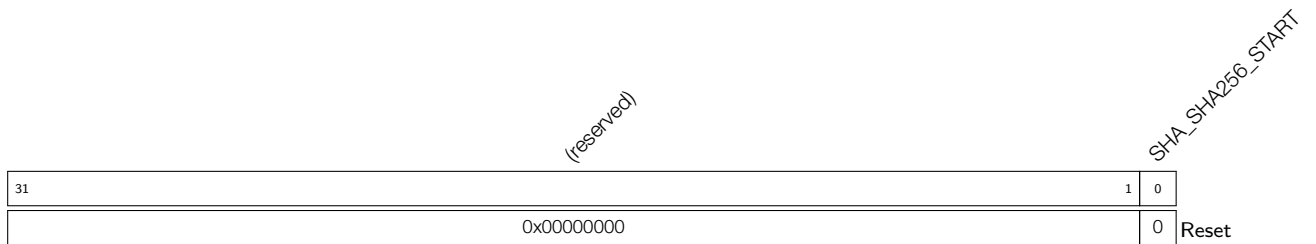

SHA_SHA256_START Write 1 to start an SHA-256 operation on the first message block. (WO)

Register 11.7: SHA_SHA256_CONTINUE_REG (0x094)

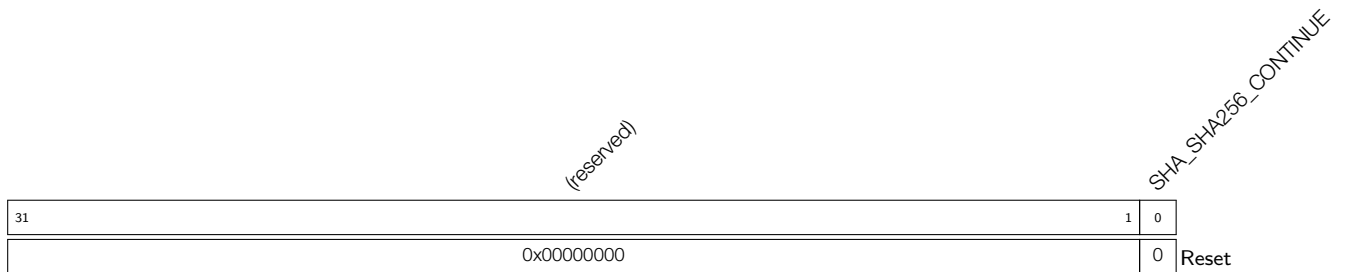

SHA_SHA256_CONTINUE Write 1 to continue the SHA-256 operation with subsequent blocks. (WO)

Register 11.8: SHA_SHA256_LOAD_REG (0x098)

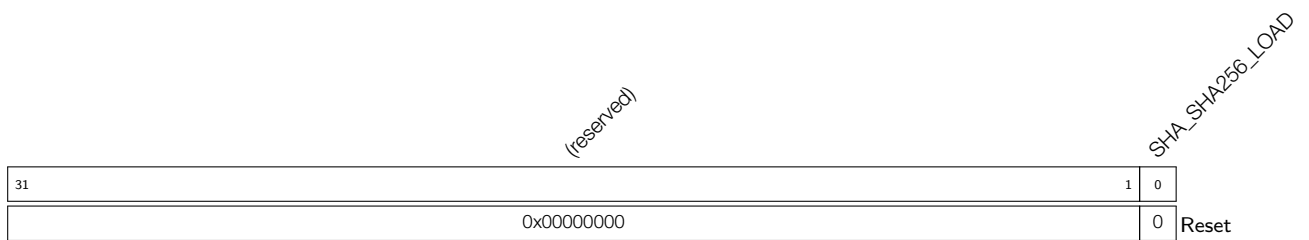

SHA_SHA256_LOAD Write 1 to finish the SHA-256 operation to calculate the final the message hash. (WO)

Register 11.9: SHA_SHA256_BUSY_REG (0x09C)

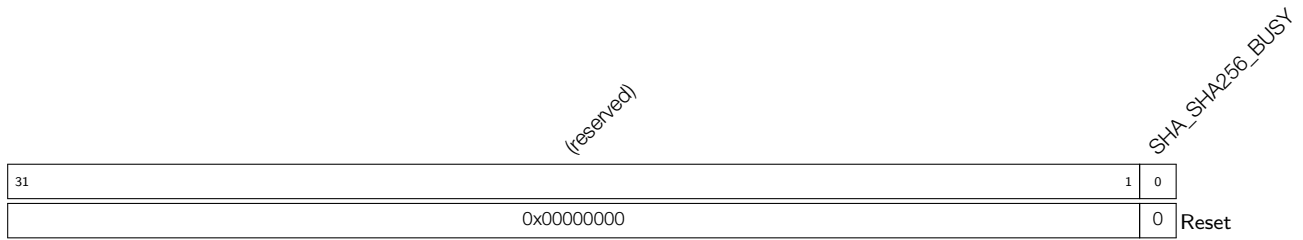

SHA_SHA256_BUSY SHA-256 operation status: 1 if the SHA accelerator is processing data, 0 if idle. (RO)

Register 11.10: SHA_SHA384_START_REG (0x0A0)

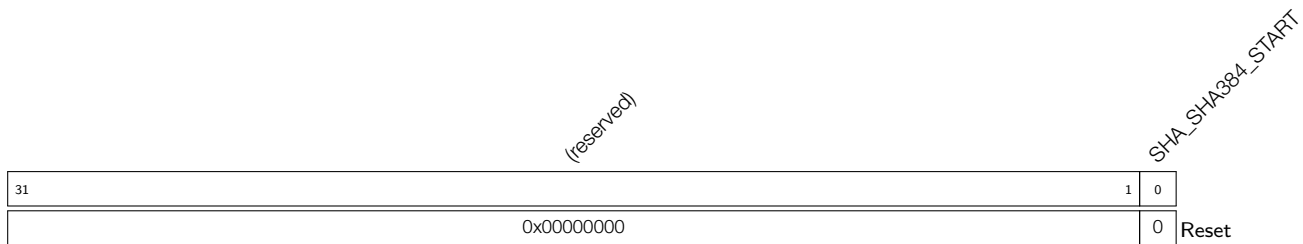

SHA_SHA384_START Write 1 to start an SHA-384 operation on the first message block. (WO)

Register 11.11: SHA_SHA384_CONTINUE_REG (0x0A4)

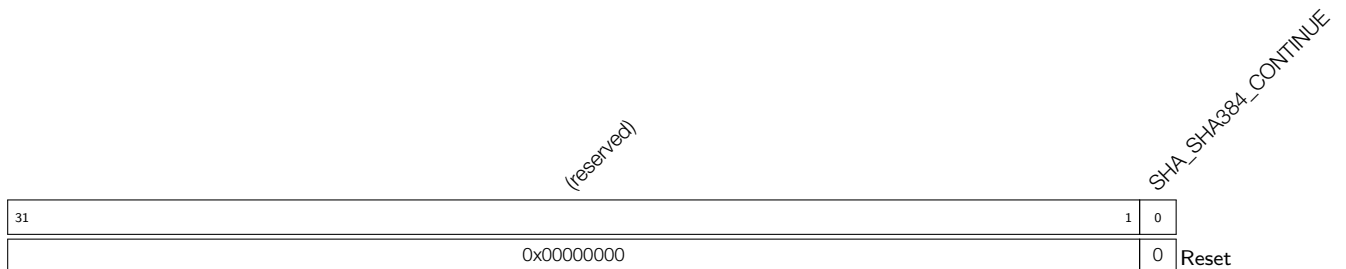

SHA_SHA384_CONTINUE Write 1 to continue the SHA-384 operation with subsequent blocks. (WO)

Register 11.12: SHA_SHA384_LOAD_REG (0x0A8)

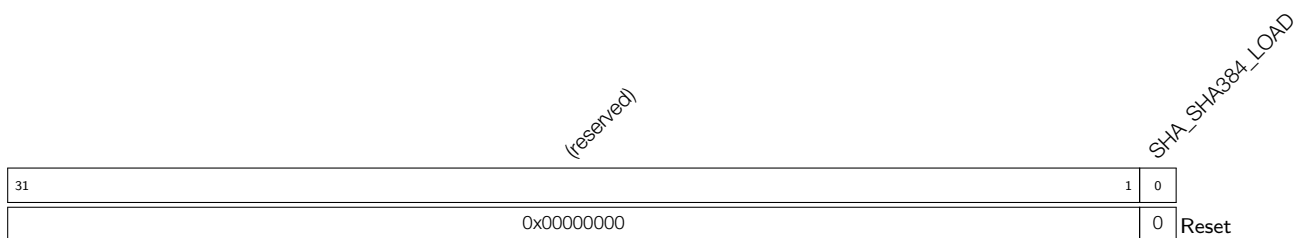

SHA_SHA384_LOAD Write 1 to finish the SHA-384 operation to calculate the final the message hash. (WO)

Register 11.13: SHA_SHA384_BUSY_REG (0x0AC)

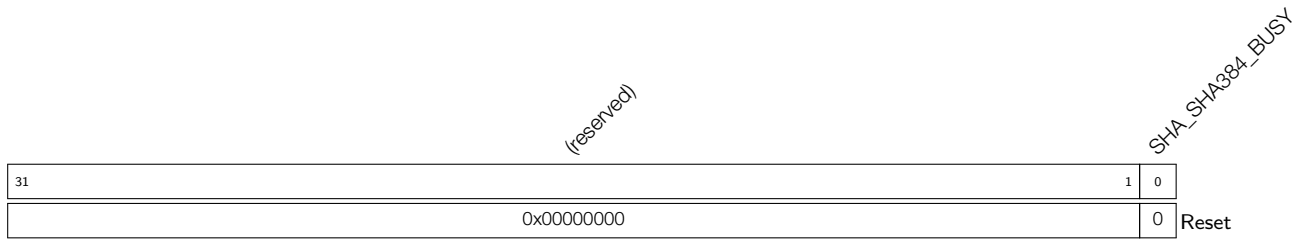

SHA_SHA384_BUSY SHA-384 operation status: 1 if the SHA accelerator is processing data, 0 if idle. (RO)

Register 11.14: SHA_SHA512_START_REG (0x0B0)

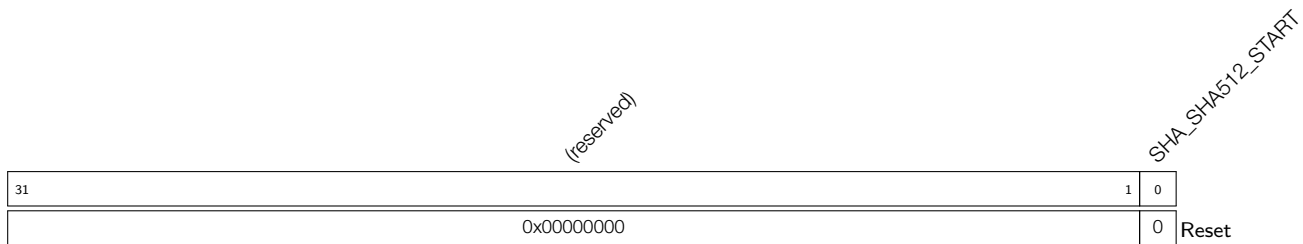

SHA_SHA512_START Write 1 to start an SHA-512 operation on the first message block. (WO)

Register 11.15: SHA_SHA512_CONTINUE_REG (0x0B4)

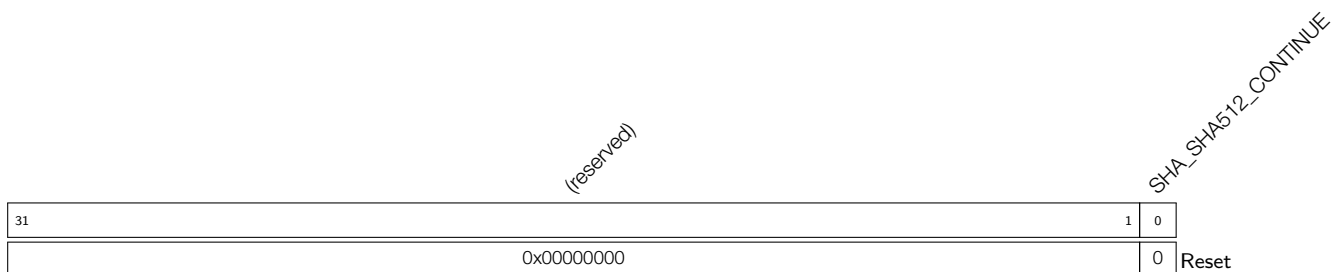

SHA_SHA512_CONTINUE Write 1 to continue the SHA-512 operation with subsequent blocks. (WO)

Register 11.16: SHA_SHA512_LOAD_REG (0x0B8)

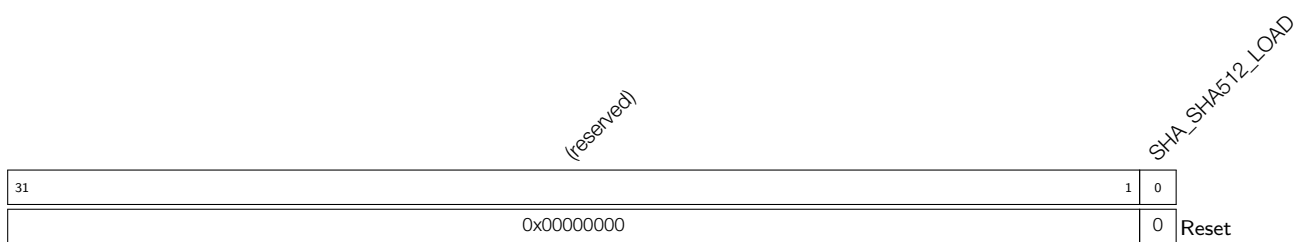

SHA_SHA512_LOAD Write 1 to finish the SHA-512 operation to calculate the final the message hash. (WO)

Register 11.17: SHA_SHA512_BUSY_REG (0x0BC)

(reserved)	SHA_SHA512_BUSY
31	1 0
0x00000000	0 Reset

SHA_SHA512_BUSY SHA-512 operation status: 1 if the SHA accelerator is processing data, 0 if idle.
(RO)